

# Building Instructions: 25\_train



Number of bricks: 512

Download LEGO Digital Designer from

[www.lego.com/ldd](http://www.lego.com/ldd)

## Step 1

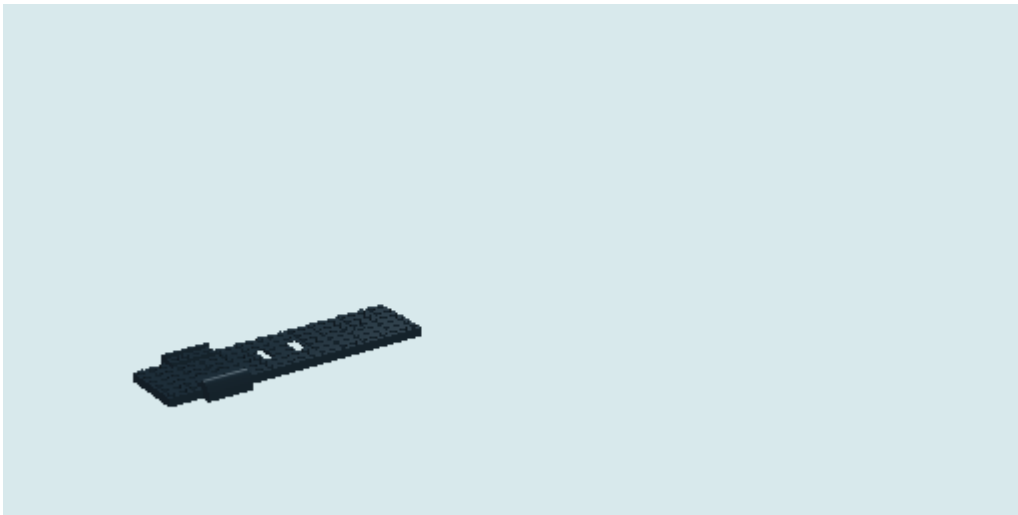
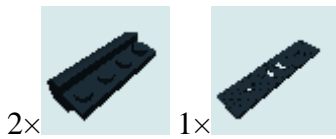

## Step 2

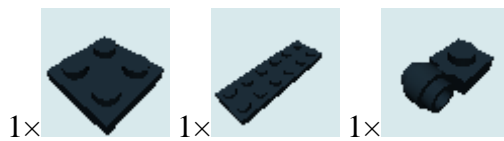

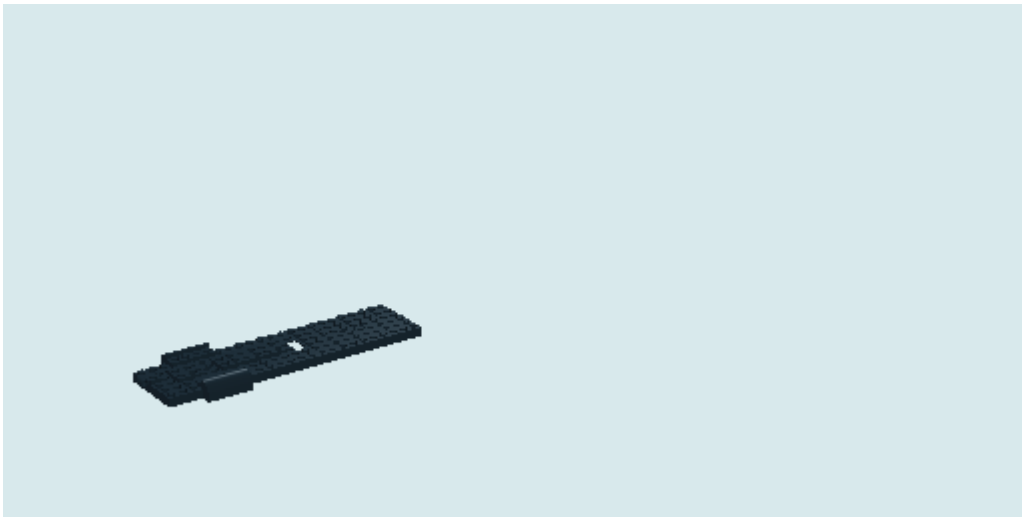

### Step 3

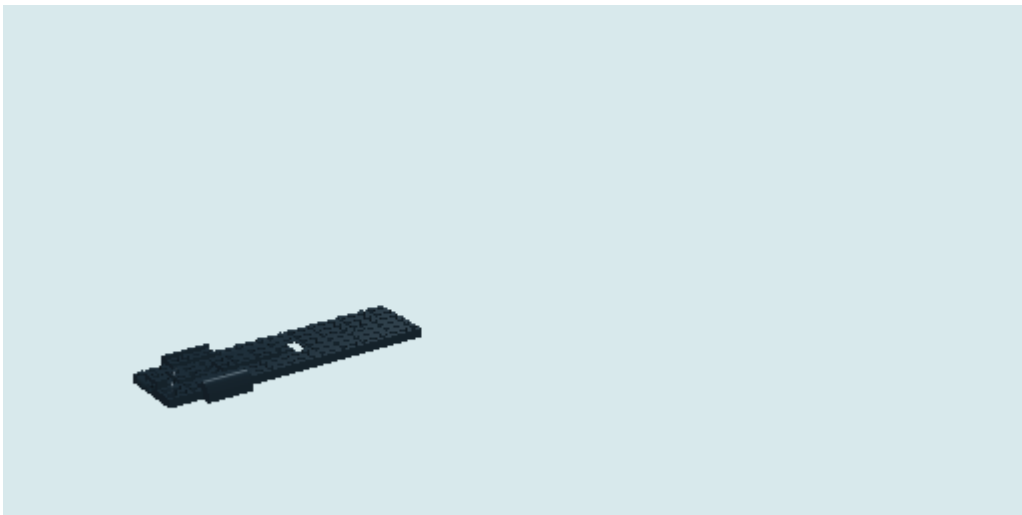

### Step 4

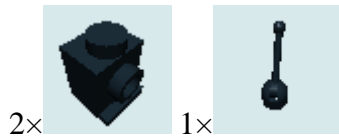

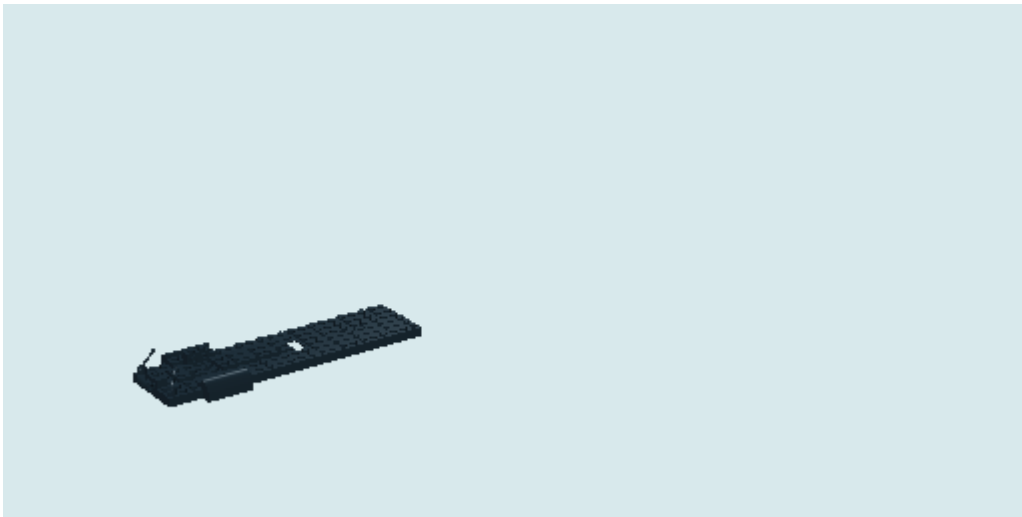

### Step 5

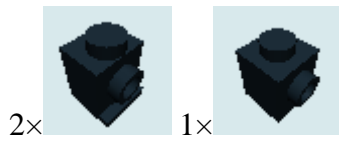

### Step 6

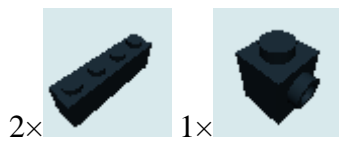



### Step 7

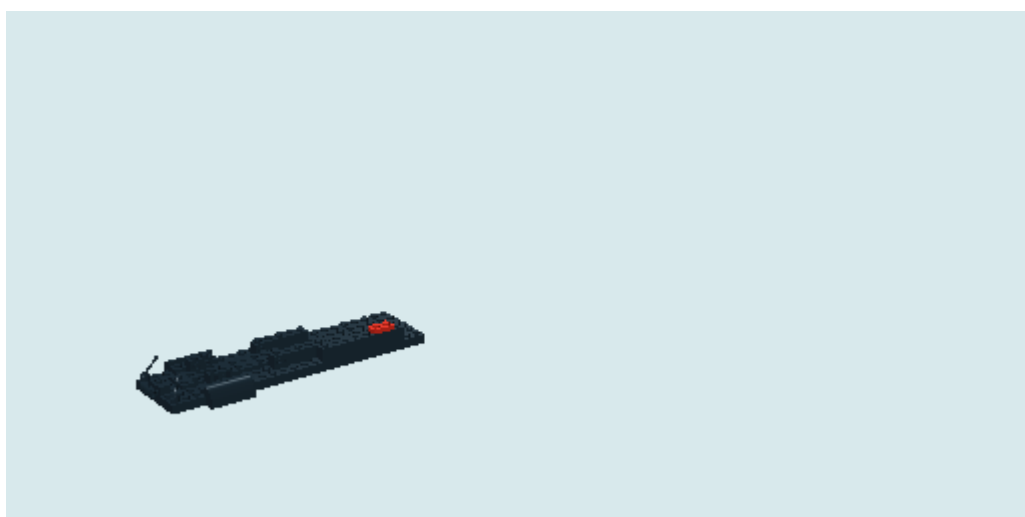

### Step 8



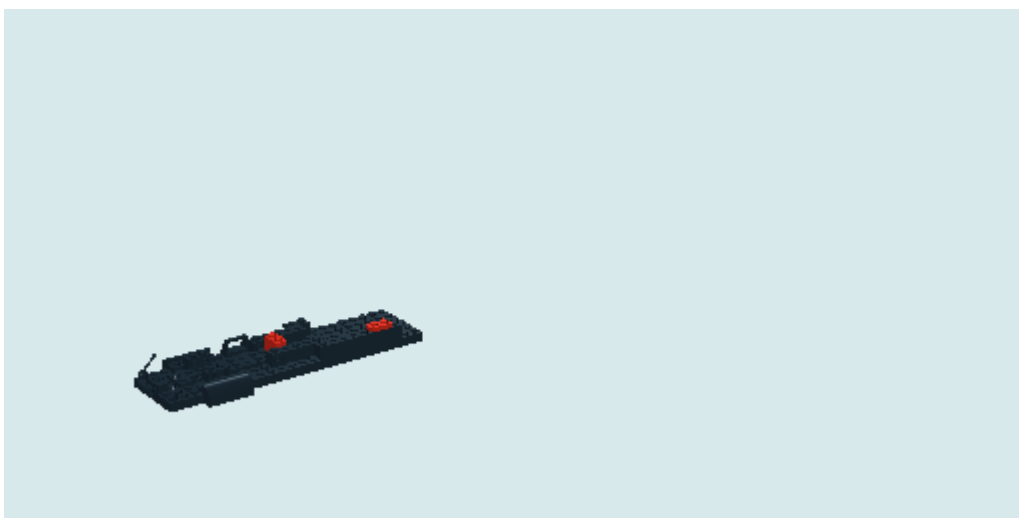

### Step 9

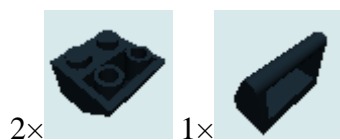

### Step 10



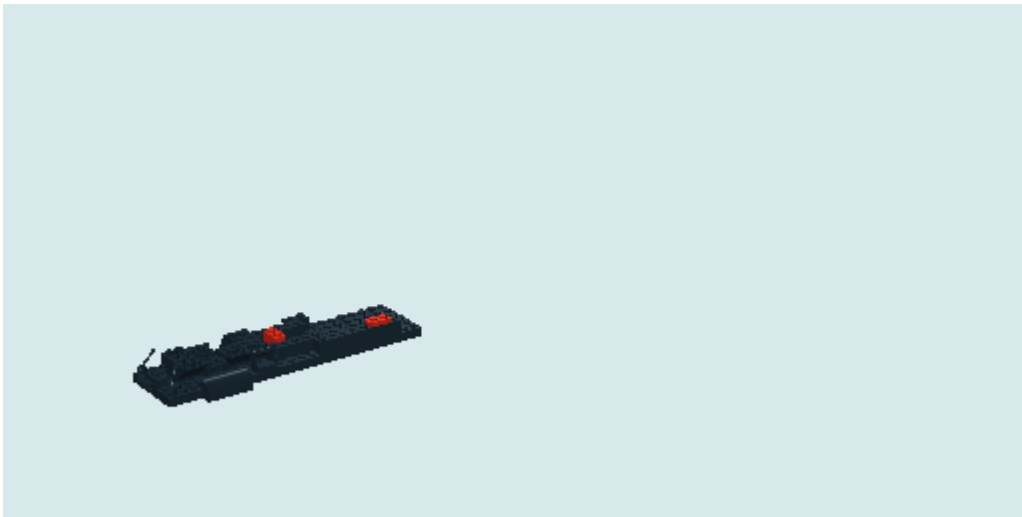

### Step 11

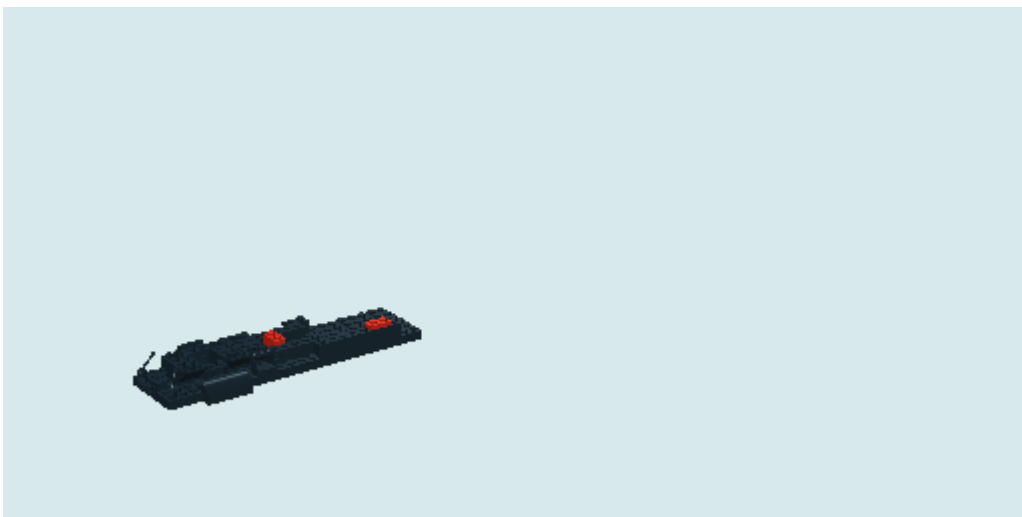
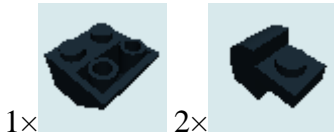

### Step 12

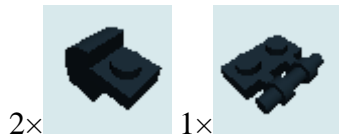

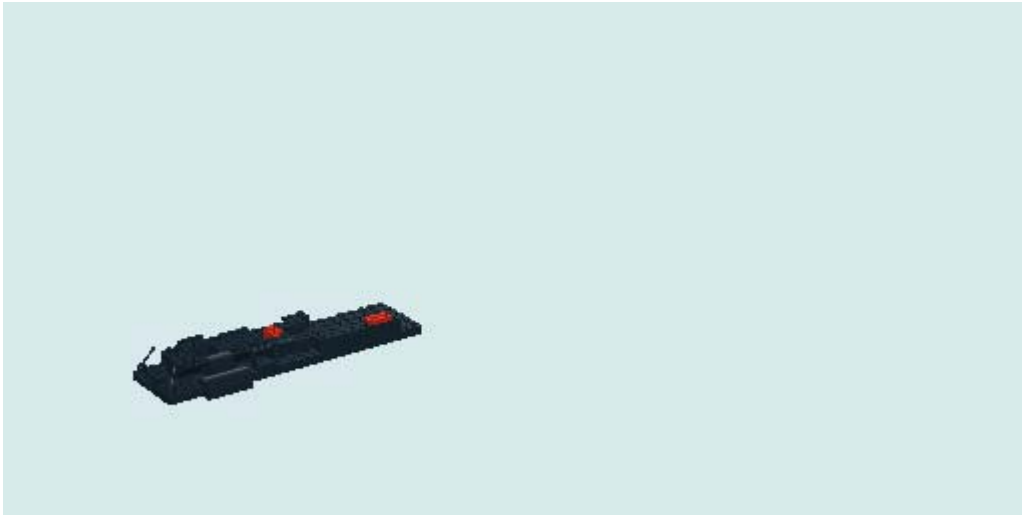

### Step 13



3x



### Step 14



2x



1x



### Step 15

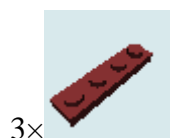

### Step 16

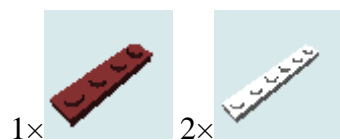



### Step 17

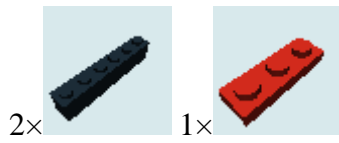

### Step 18

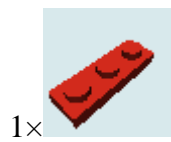



### Step 19

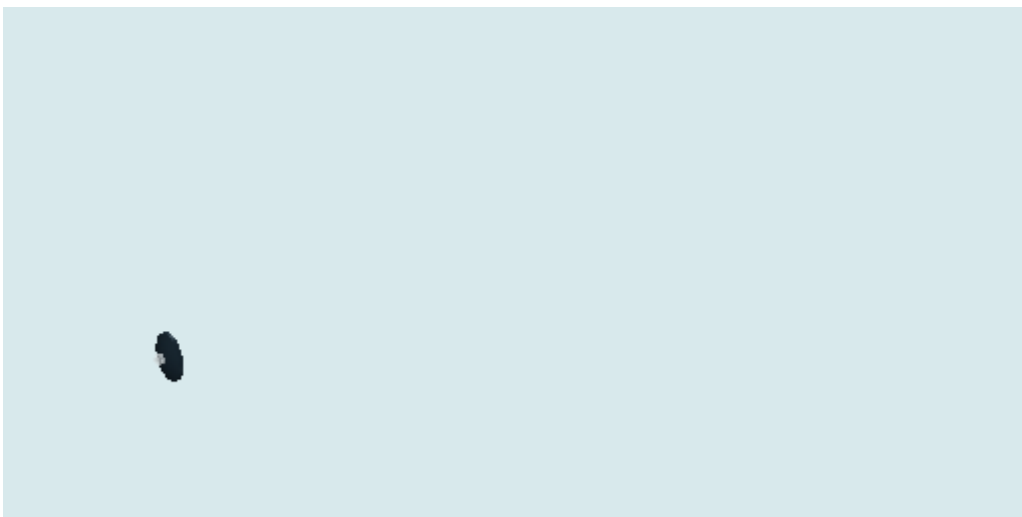
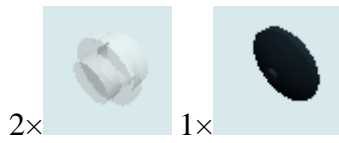

### Step 20



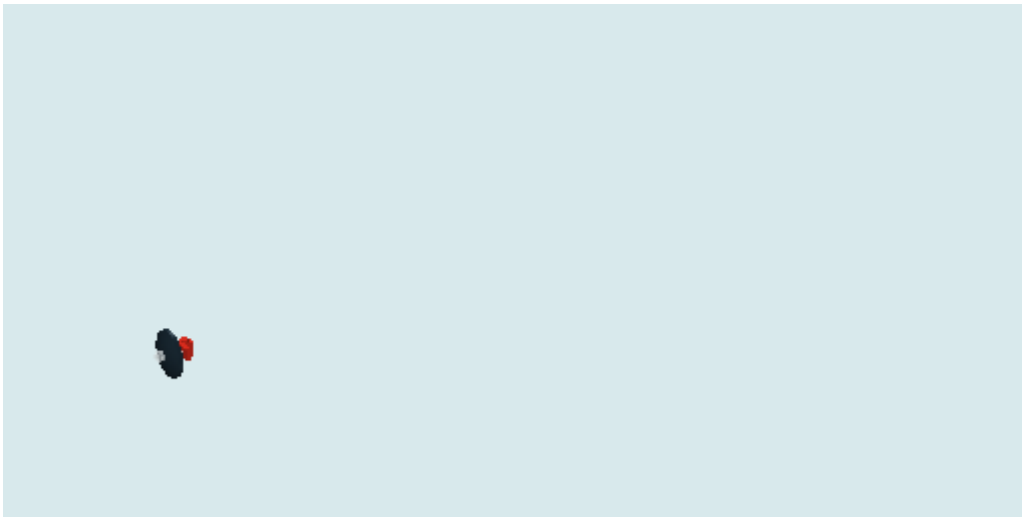

### Step 21



1x

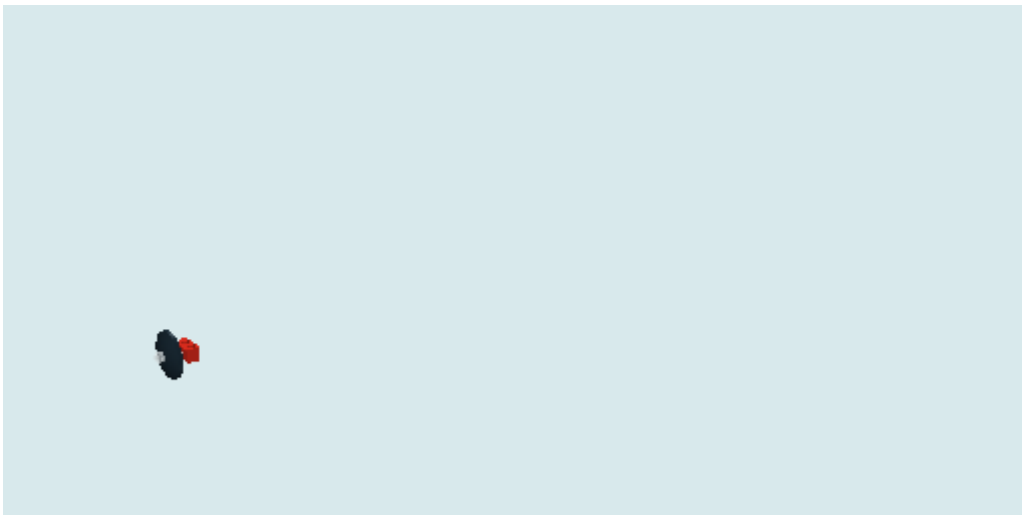

### Step 22



### Step 23

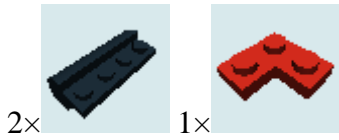

### Step 24



### Step 25

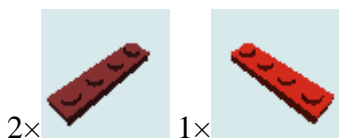



### Step 26

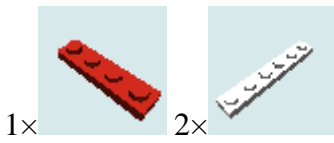

### Step 27

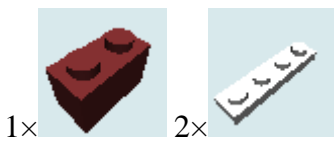



### Step 28

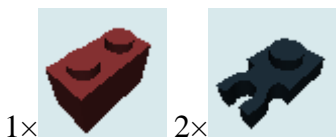

### Step 29

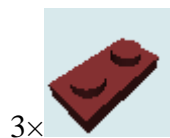

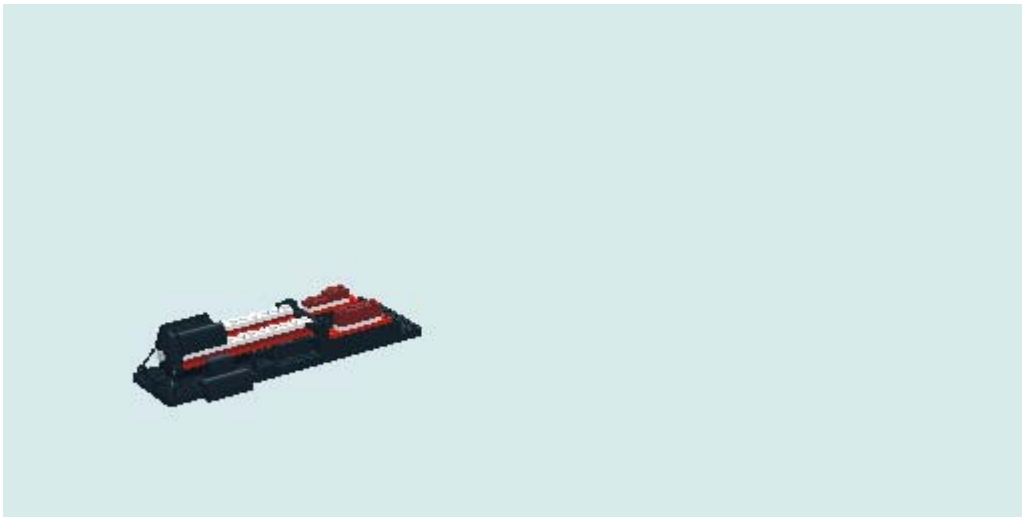

### Step 30

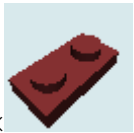

3x



### Step 31



3x



### Step 32

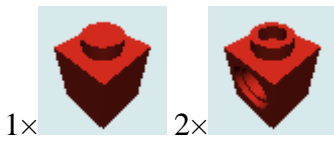

### Step 33

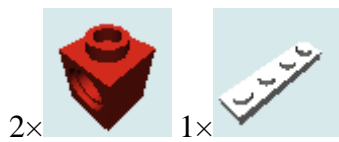



### Step 34

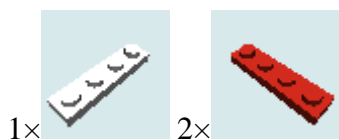

### Step 35

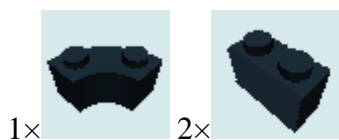

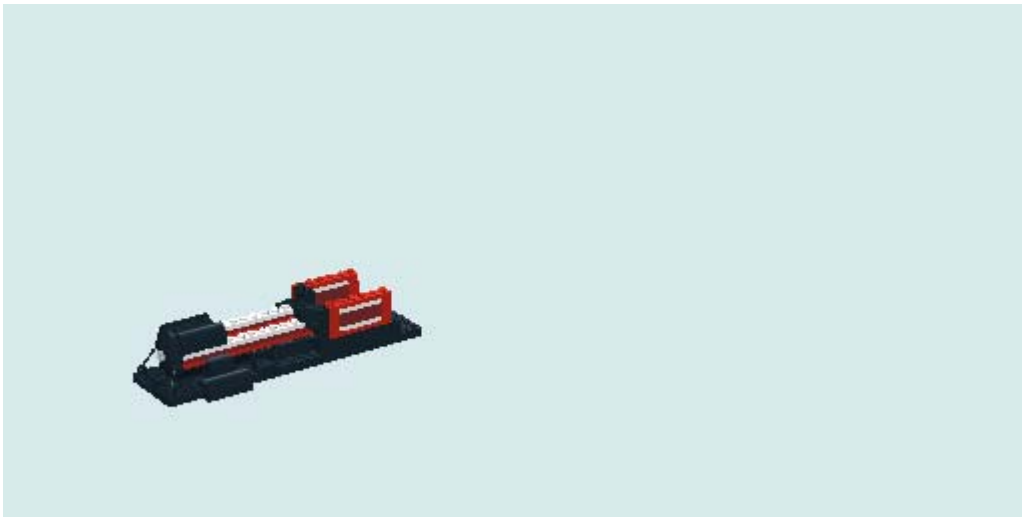

### Step 36

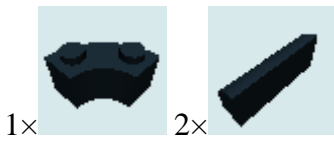

### Step 37

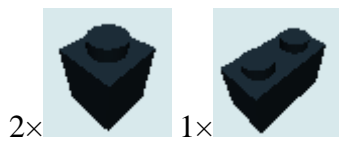

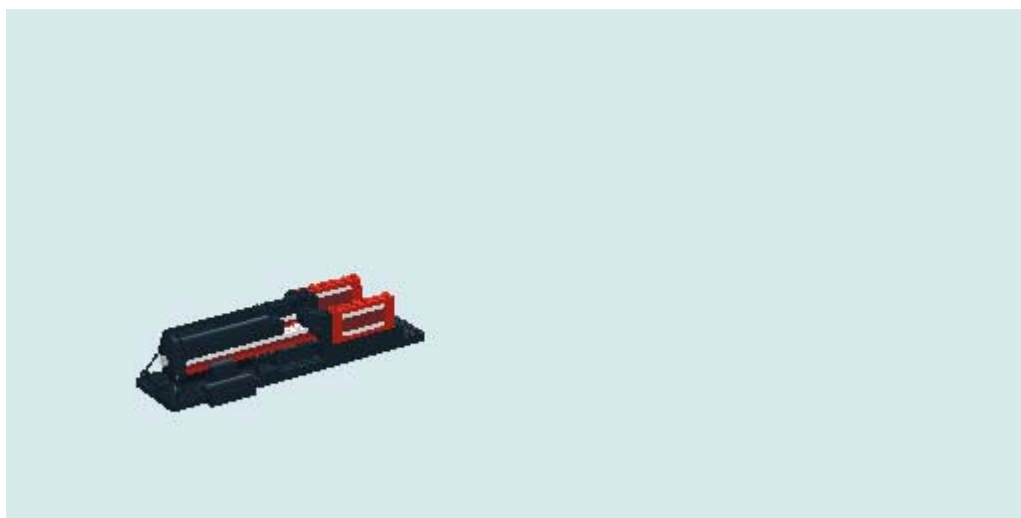

### Step 38

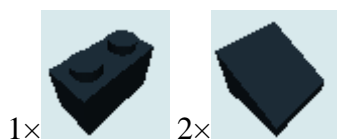

### Step 39

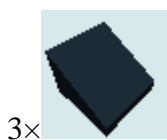



### Step 40



3x

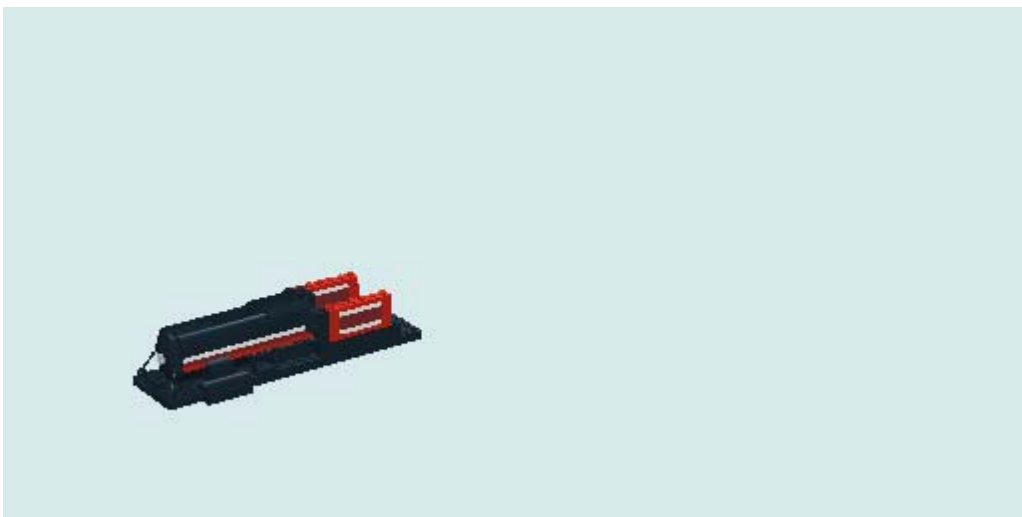

### Step 41



1x

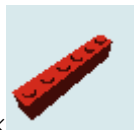

2x



### Step 42



### Step 43



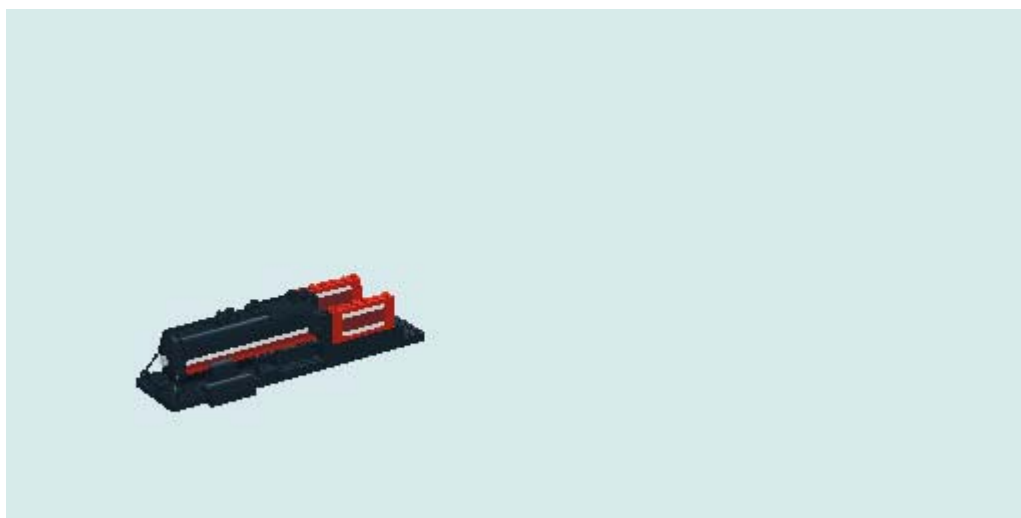

### Step 44

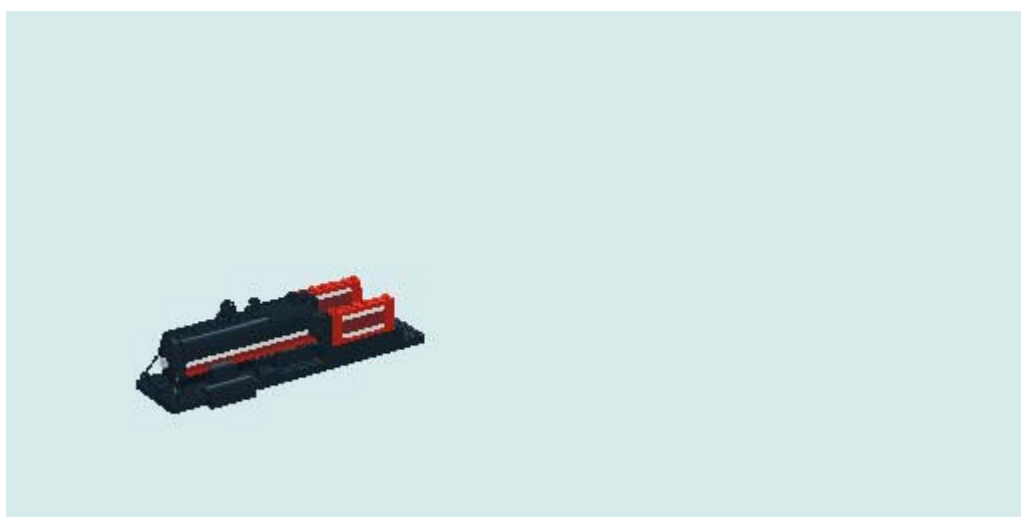

### Step 45



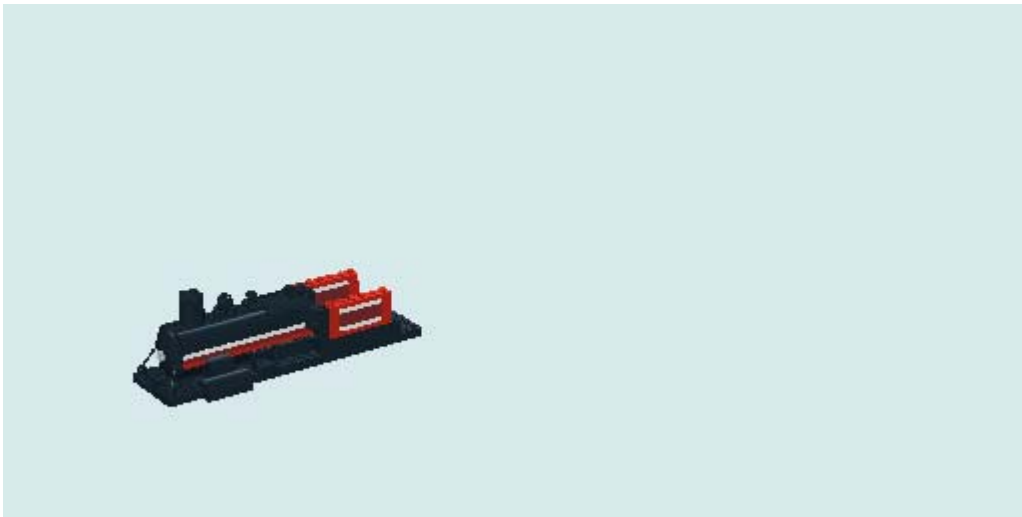

### Step 46



### Step 47





### Step 48

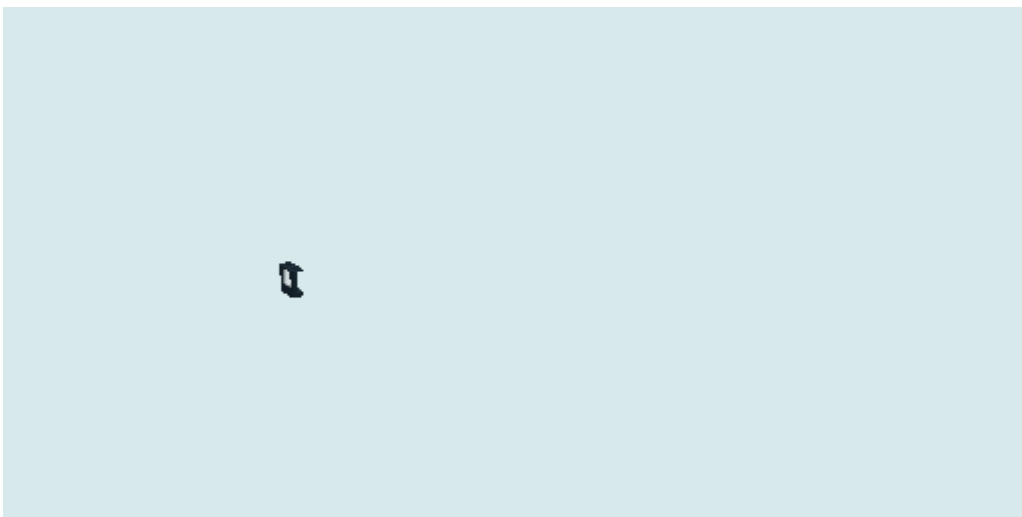
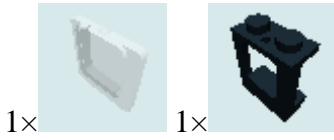

### Step 49



## Step 50

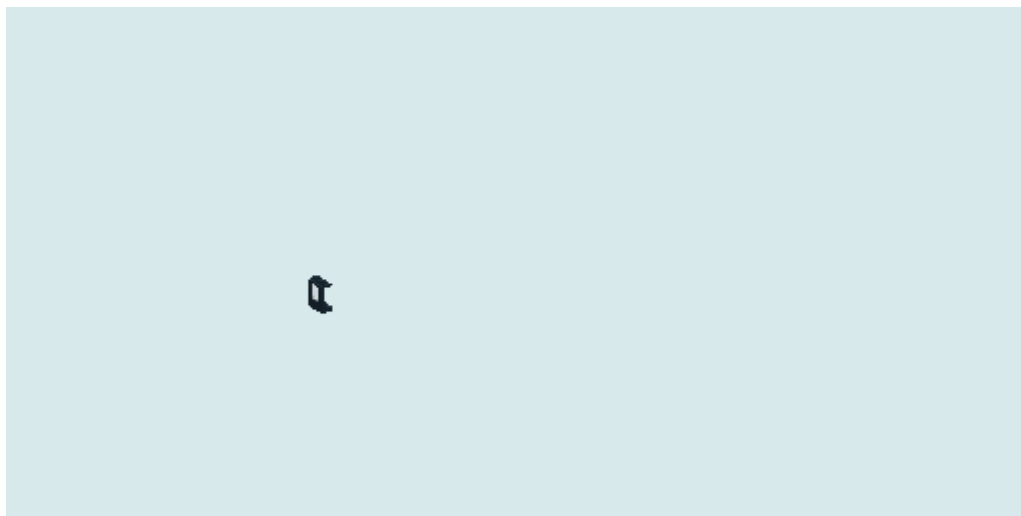
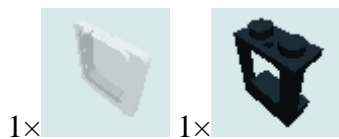

## Step 51



## Step 52





### Step 53

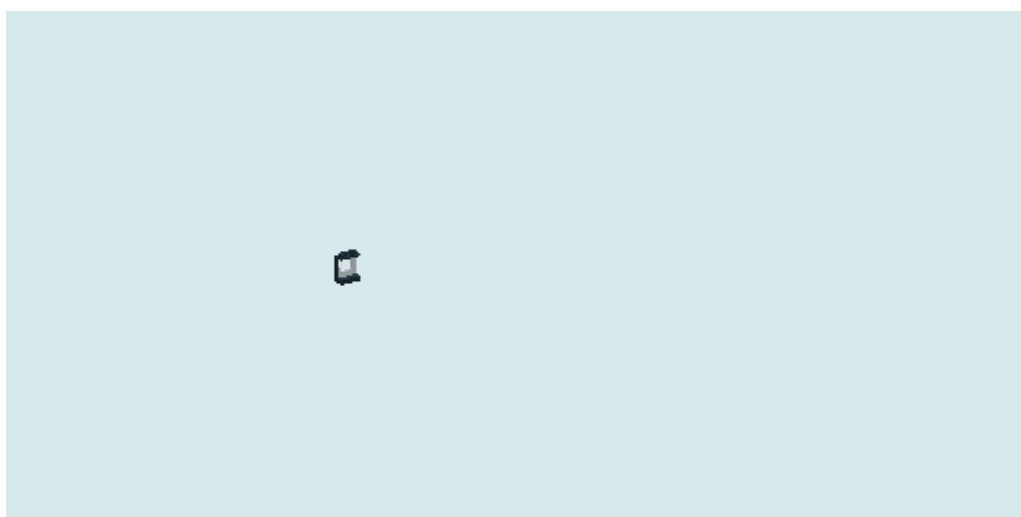
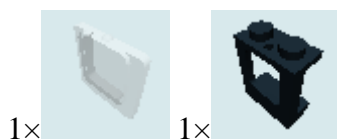

### Step 54



### Step 55

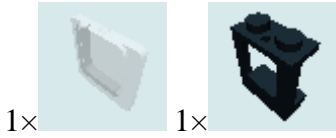

### Step 56



### Step 57

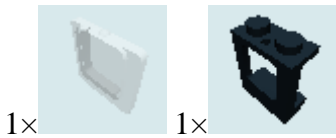



### Step 58



### Step 59



2x

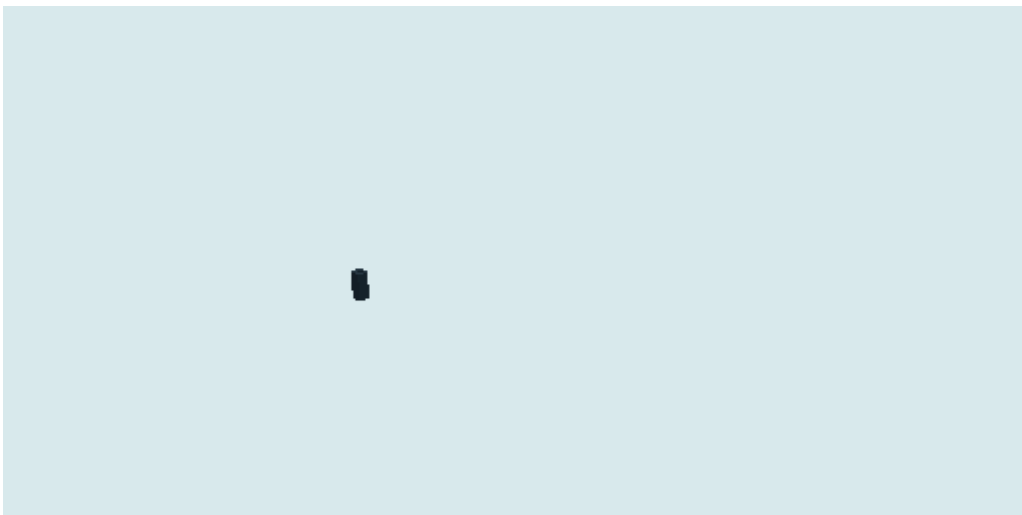

### Step 60



### Step 61

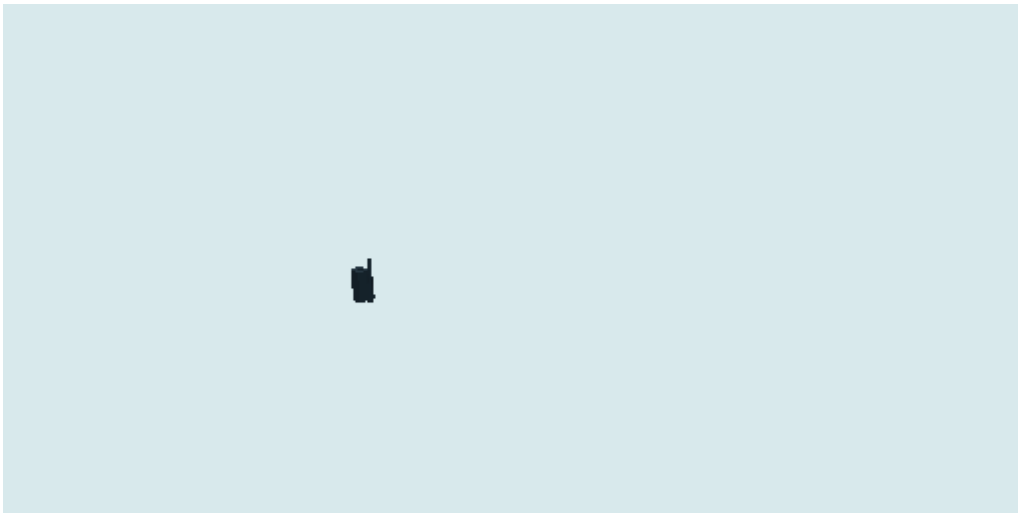

### Step 62



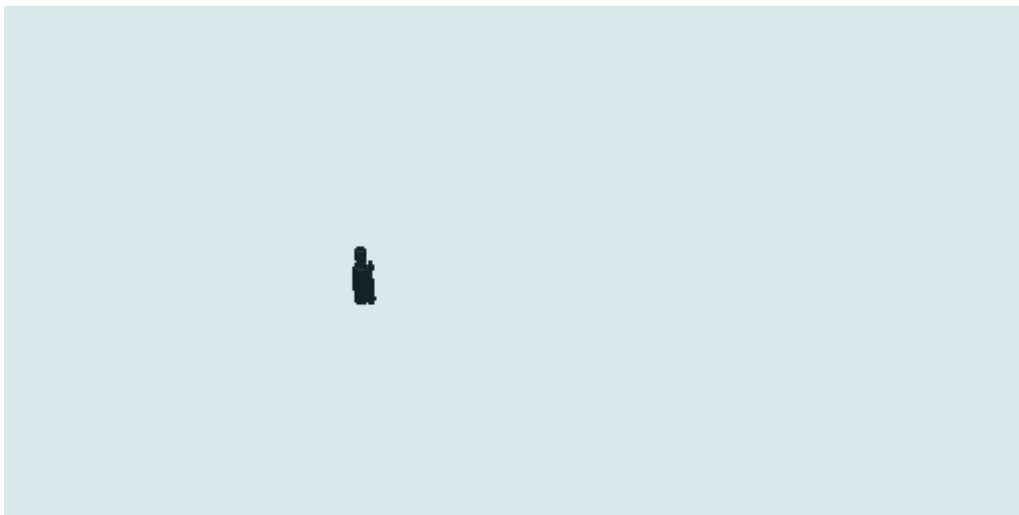

### Step 63



### Step 64



## Step 65

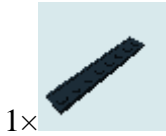

## Step 66

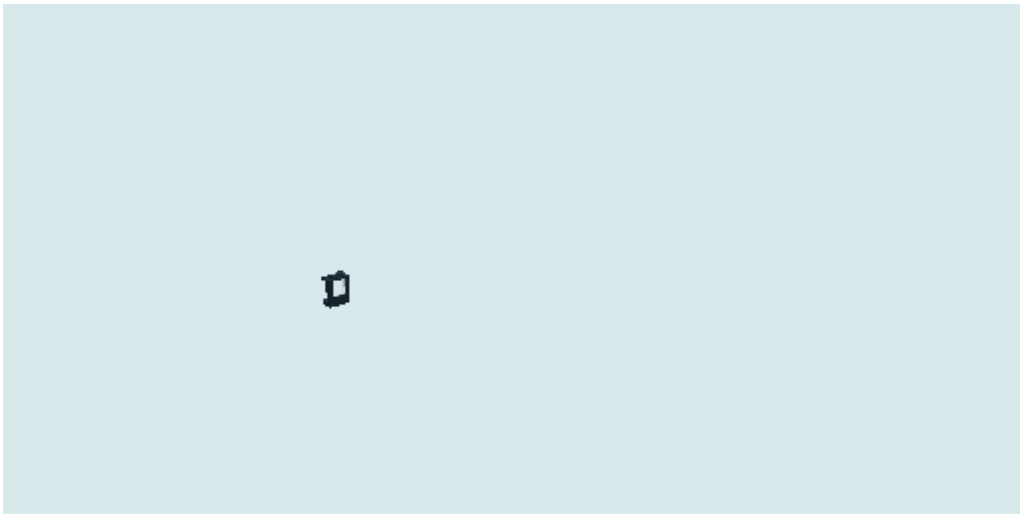
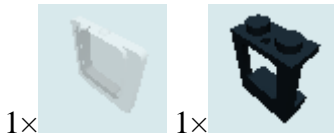

## Step 67



### Step 68

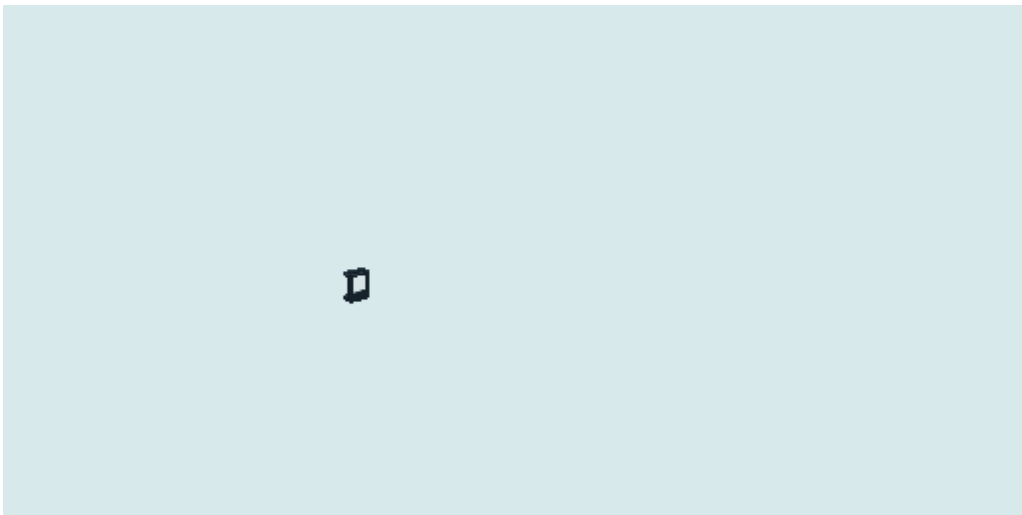
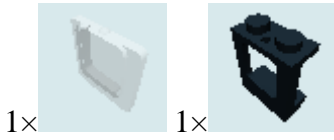

### Step 69



## Step 70

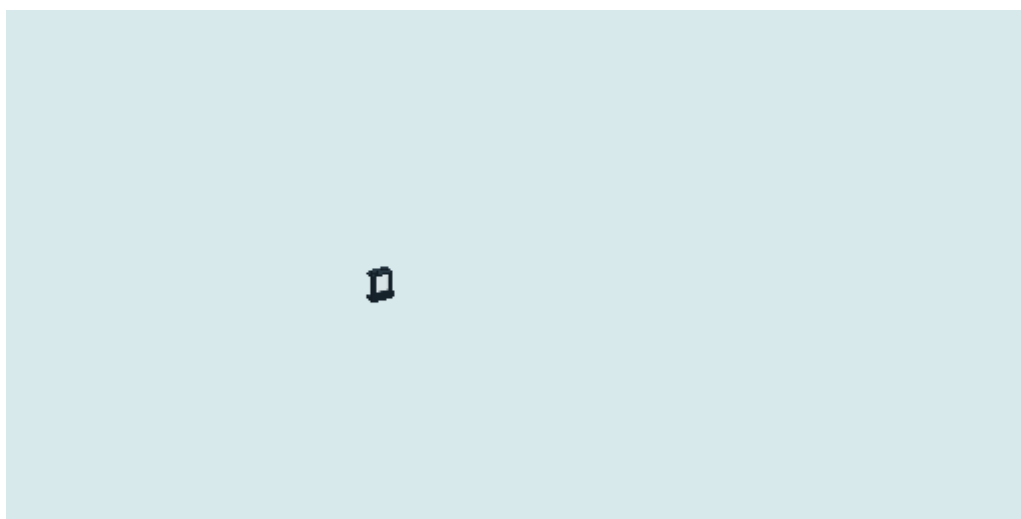
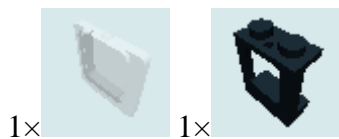

## Step 71



## Step 72

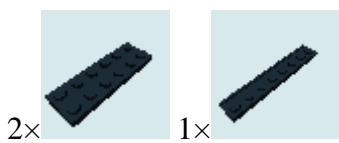



### Step 73



2x

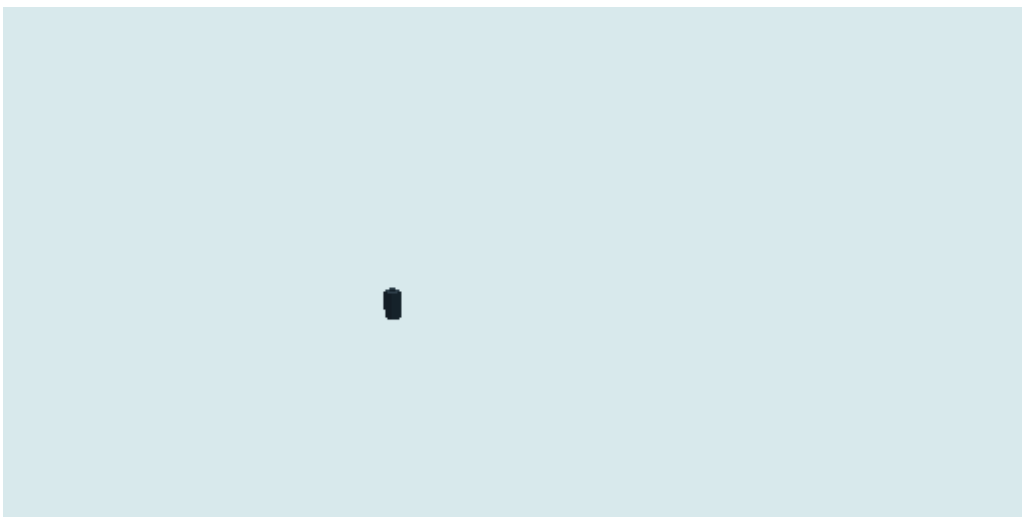

### Step 74



1x



1x



### Step 75

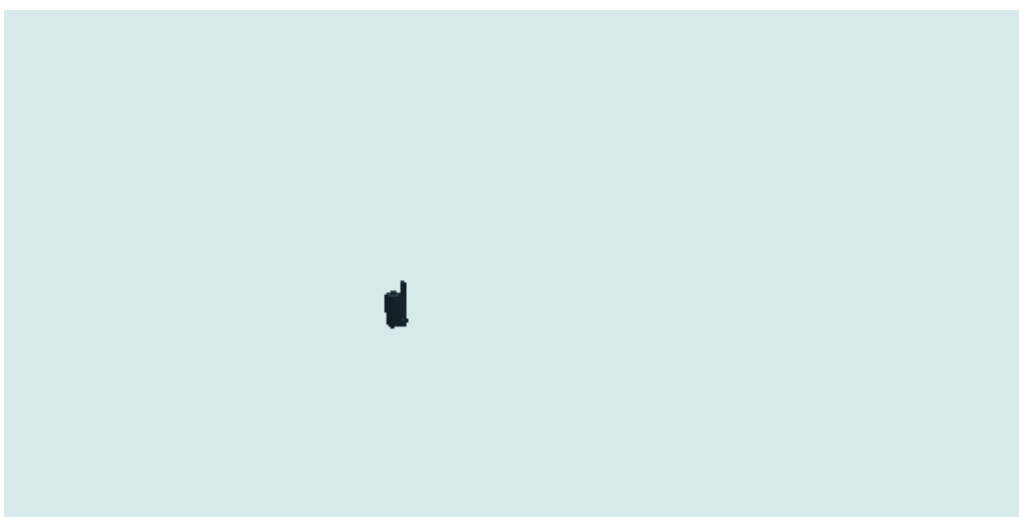

### Step 76

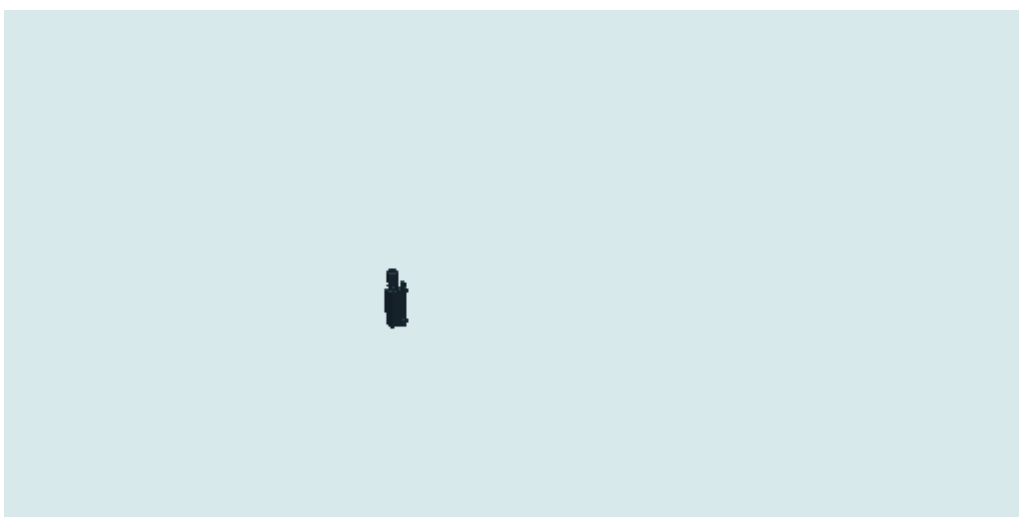

### Step 77



1x

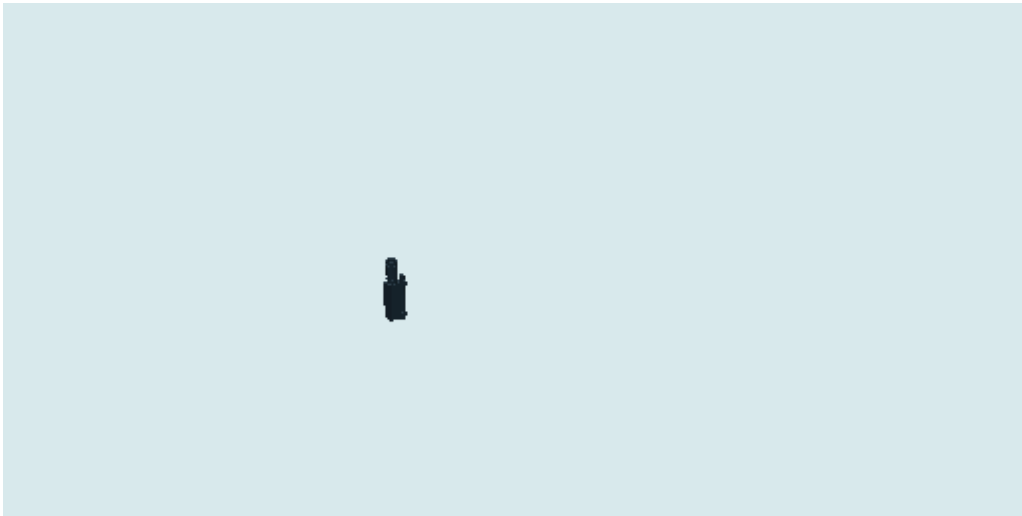

### Step 78



### Step 79



1x



1x



1x



### Step 80



3x

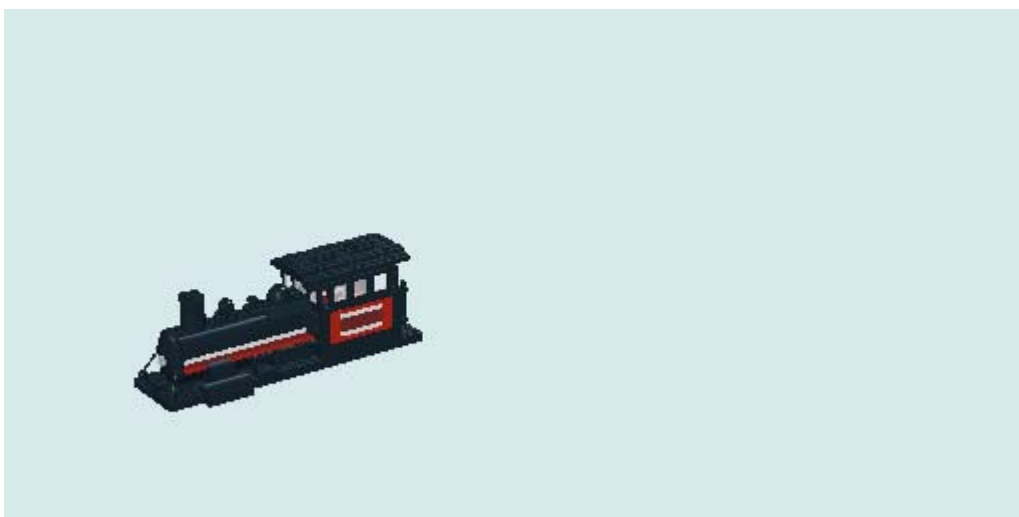

### Step 81



2x

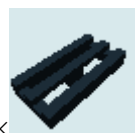

1x



### Step 82



1x



### Step 83



1x



1x

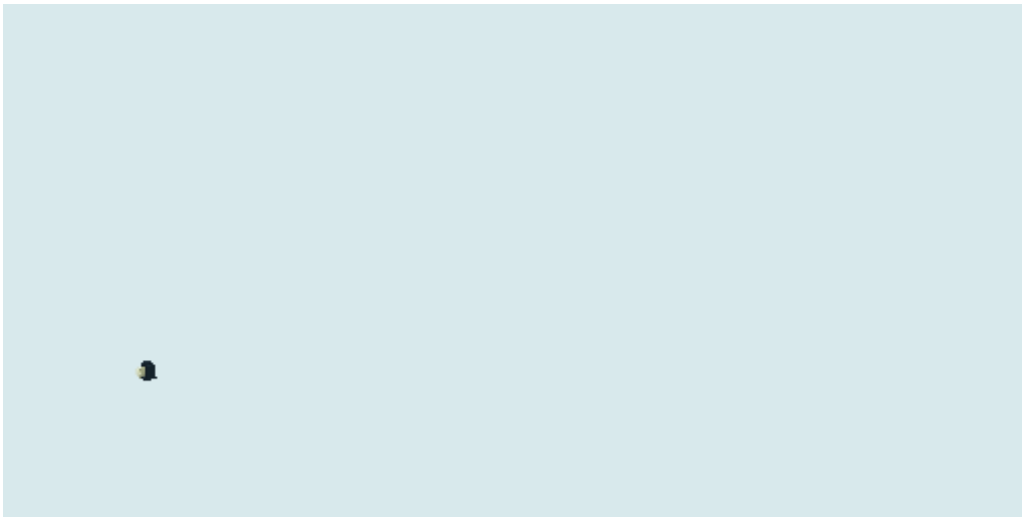

### Step 84



### Step 85

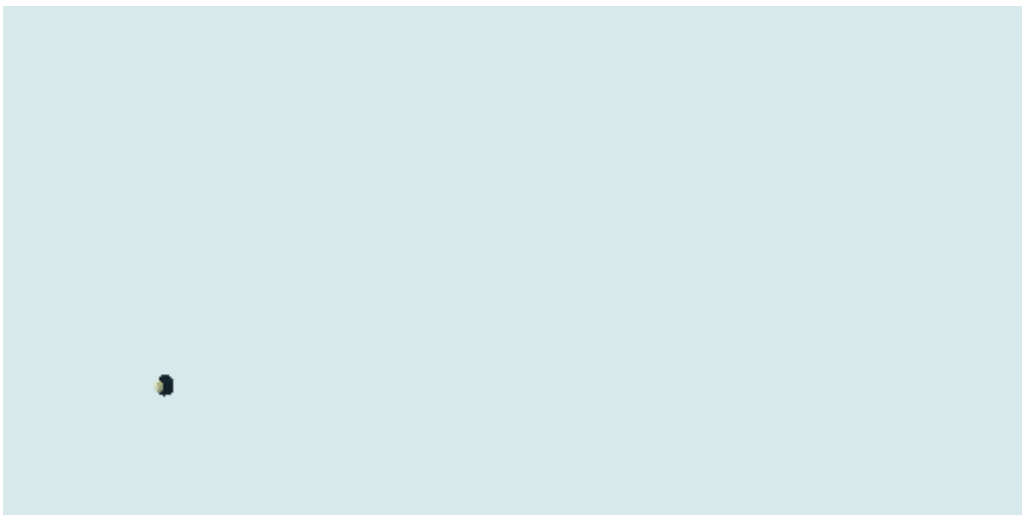

## Step 86

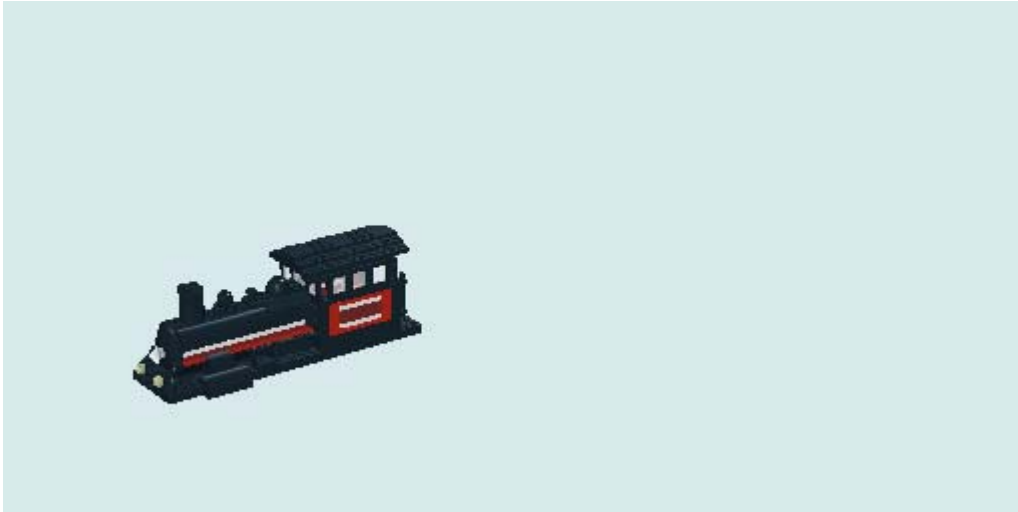

## Step 87



## Step 88





### Step 89

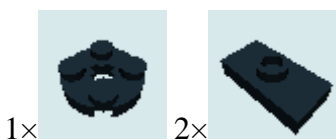

### Step 90





### Step 91



### Step 92

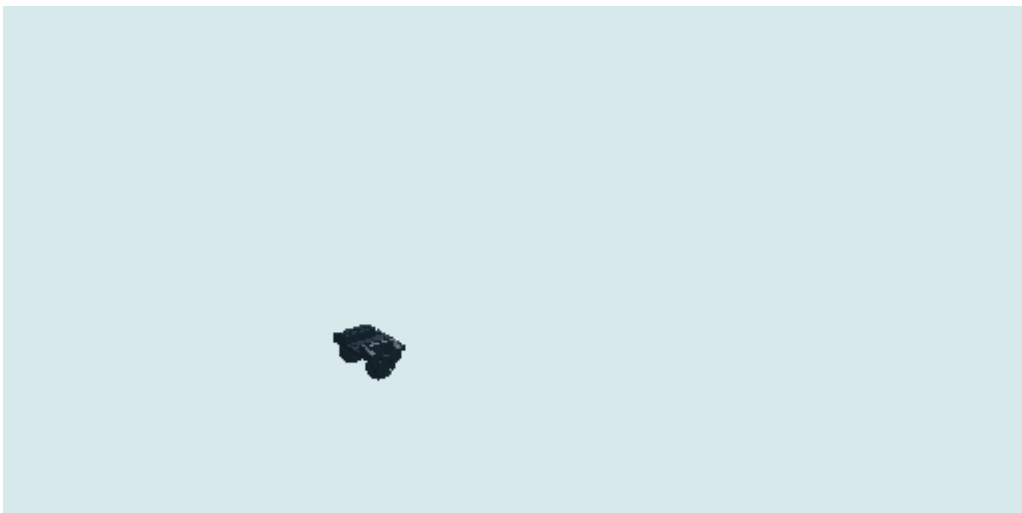
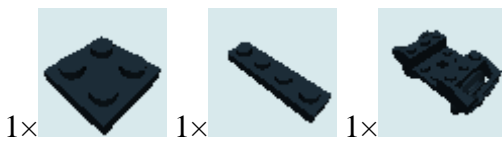

## Step 93

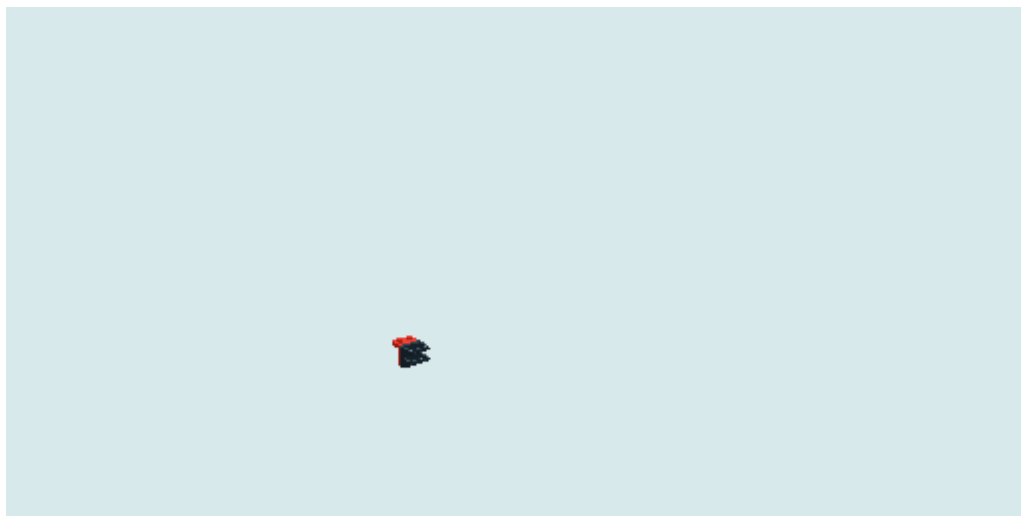
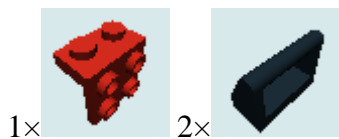

## Step 94

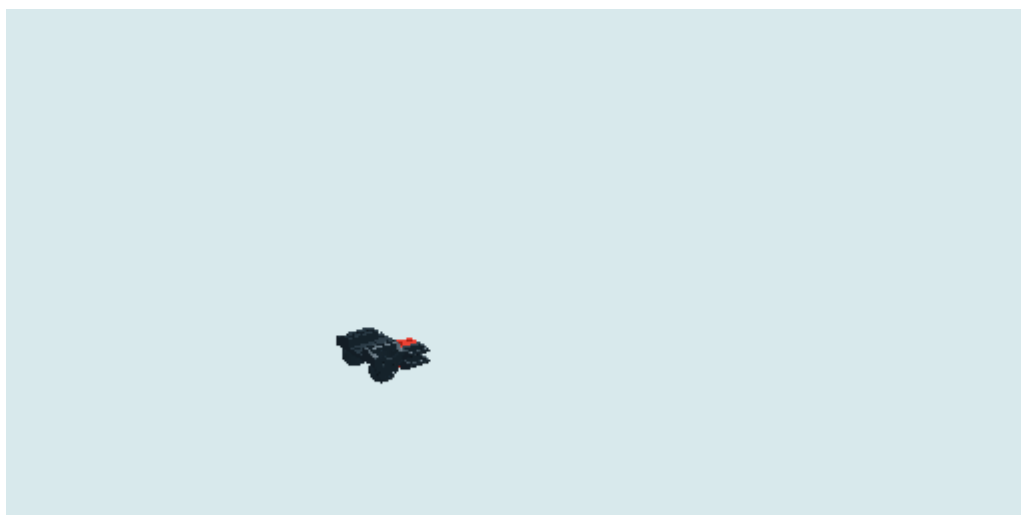

## Step 95



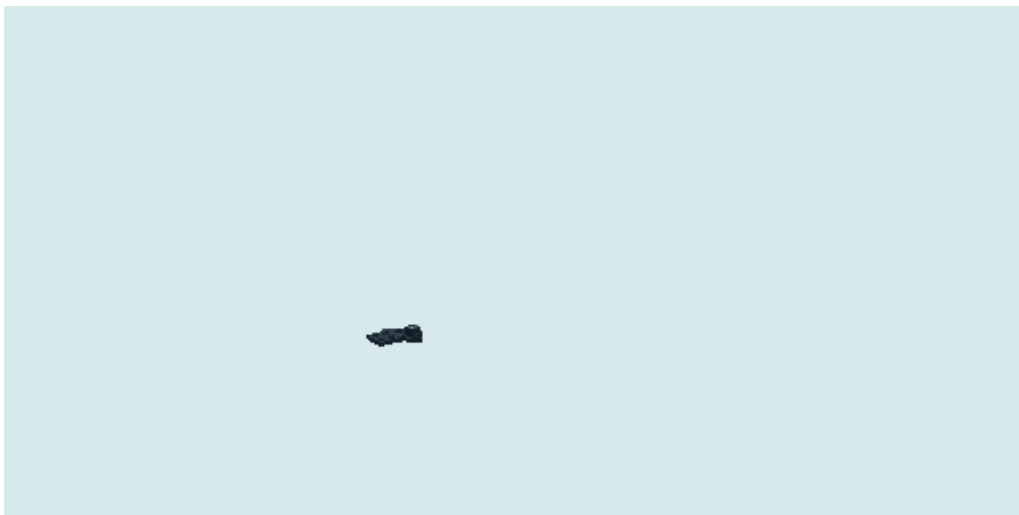

### Step 96

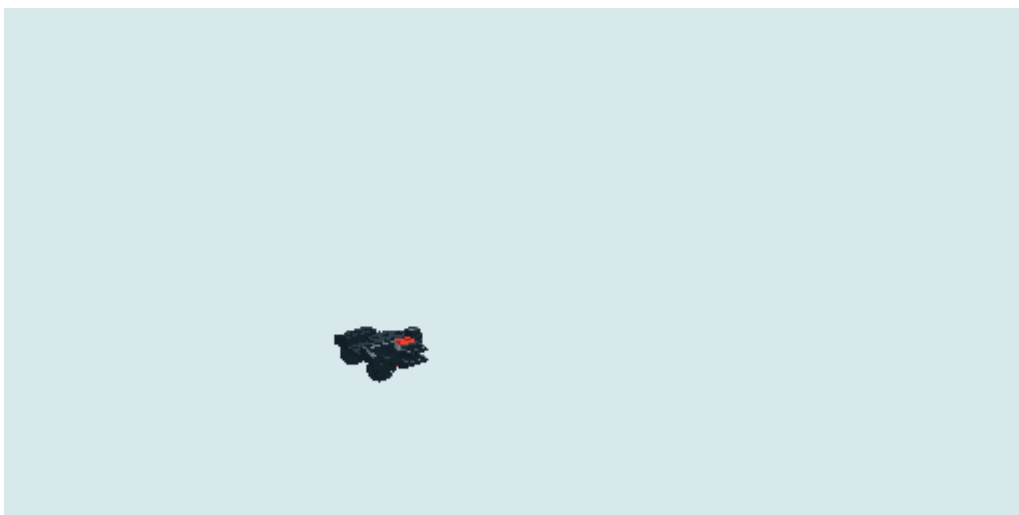

### Step 97

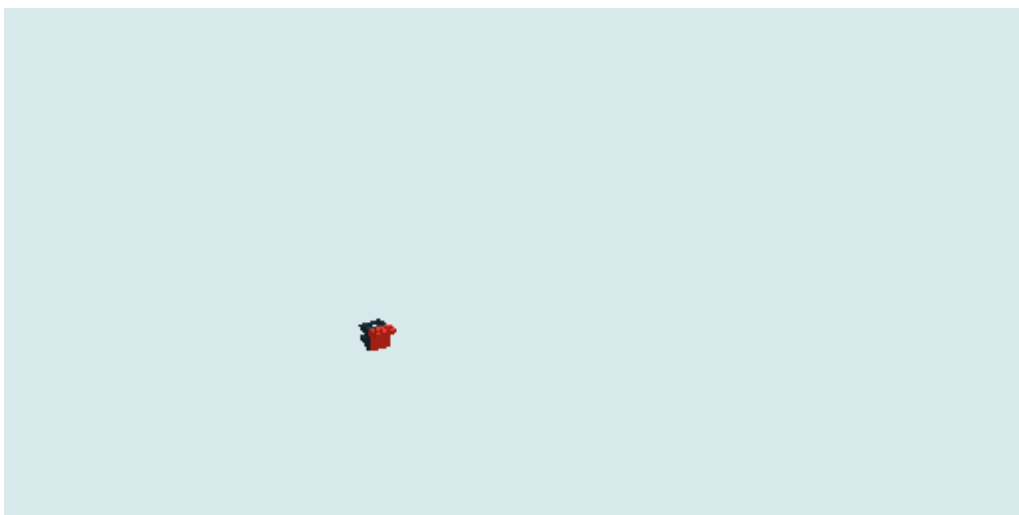
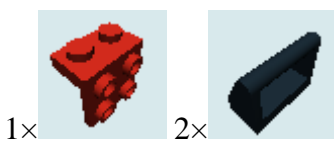

### Step 98

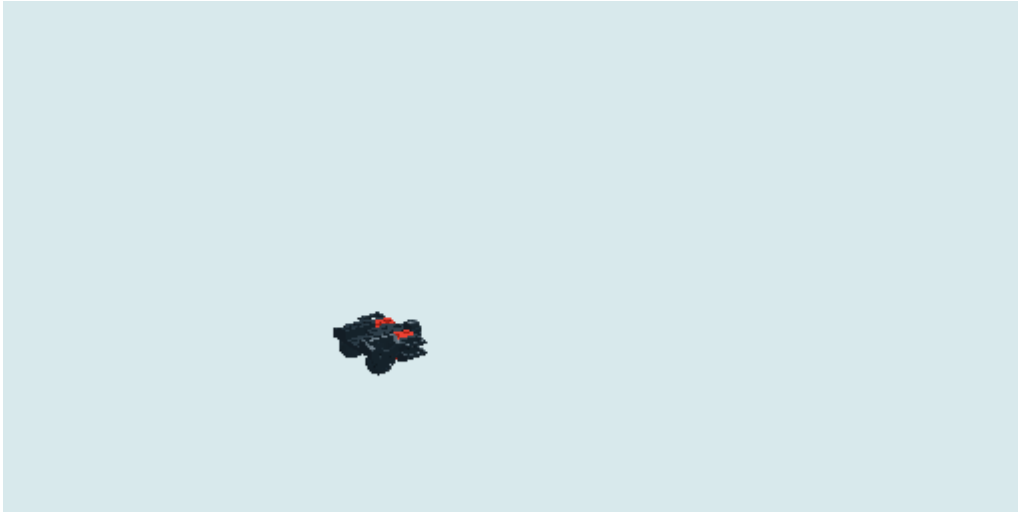

### Step 99

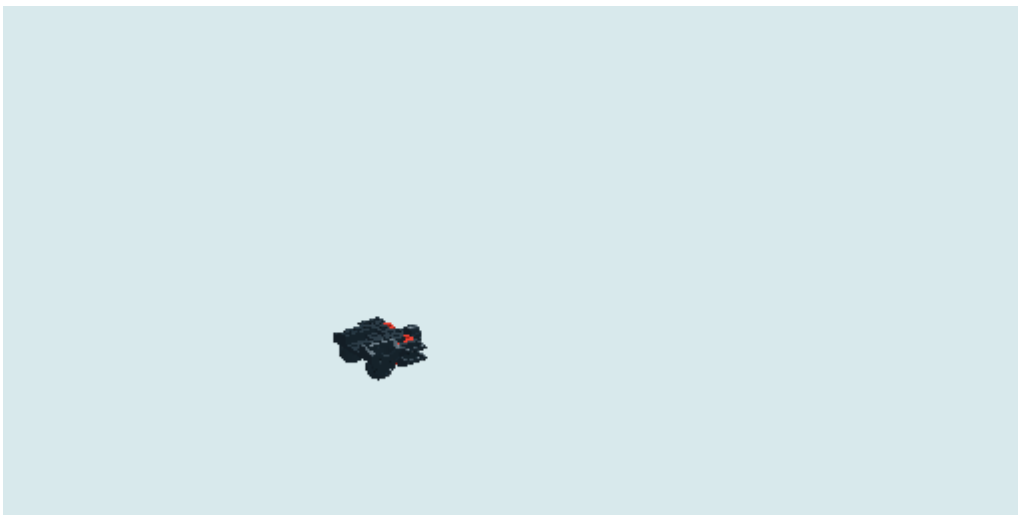

### Step 100

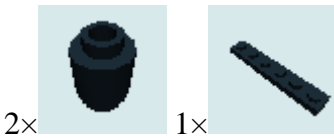

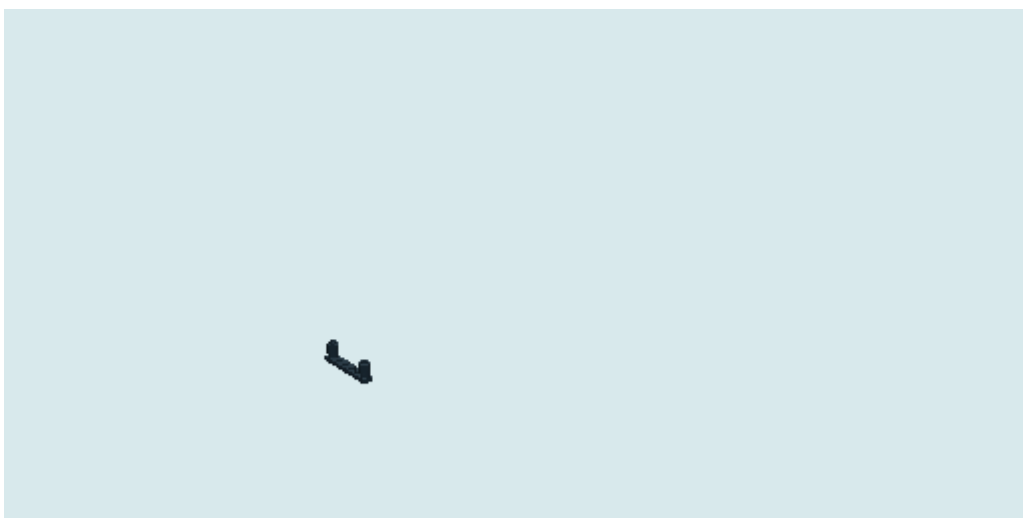

### Step 101

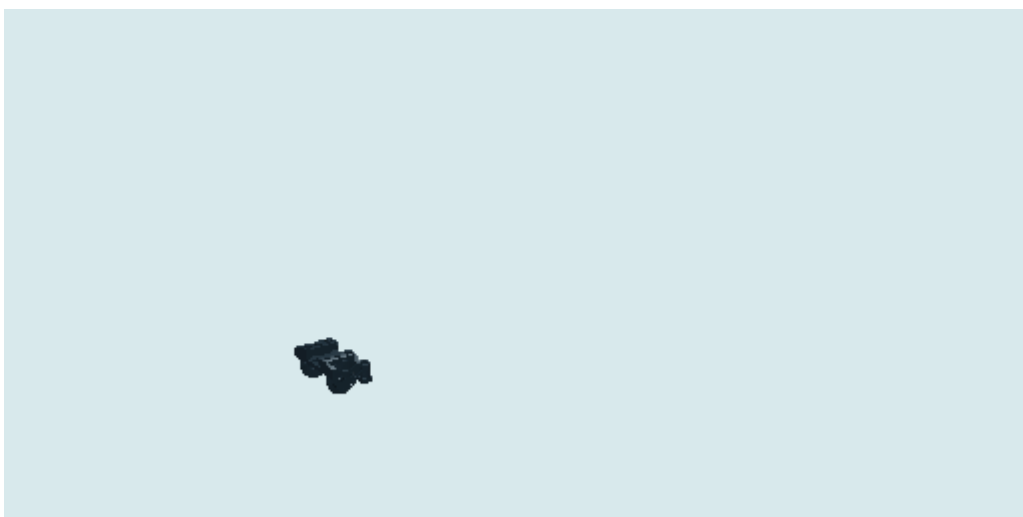

### Step 102





### Step 103

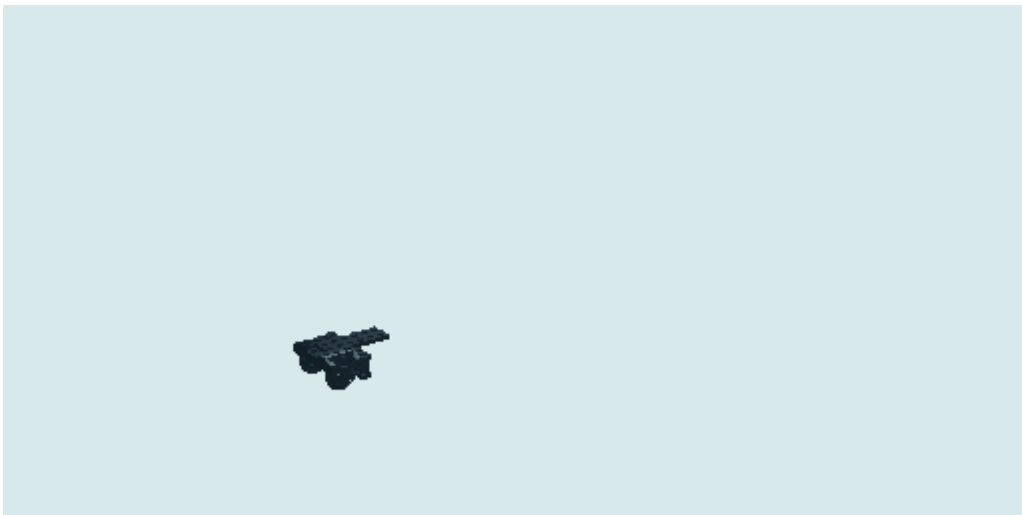
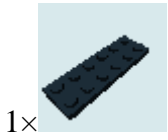

### Step 104



### Step 105



1x



### Step 106



### Step 107



1x



1x



1x

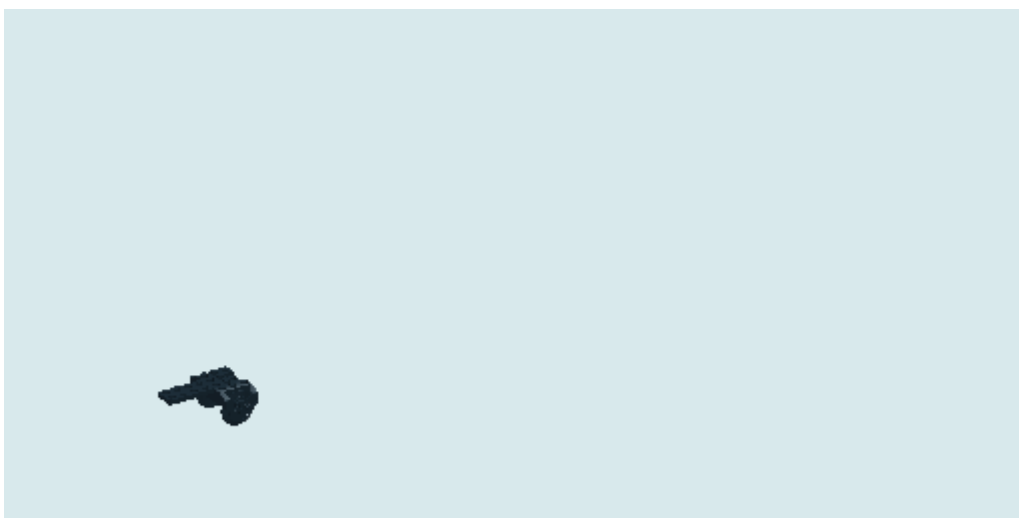

### Step 108

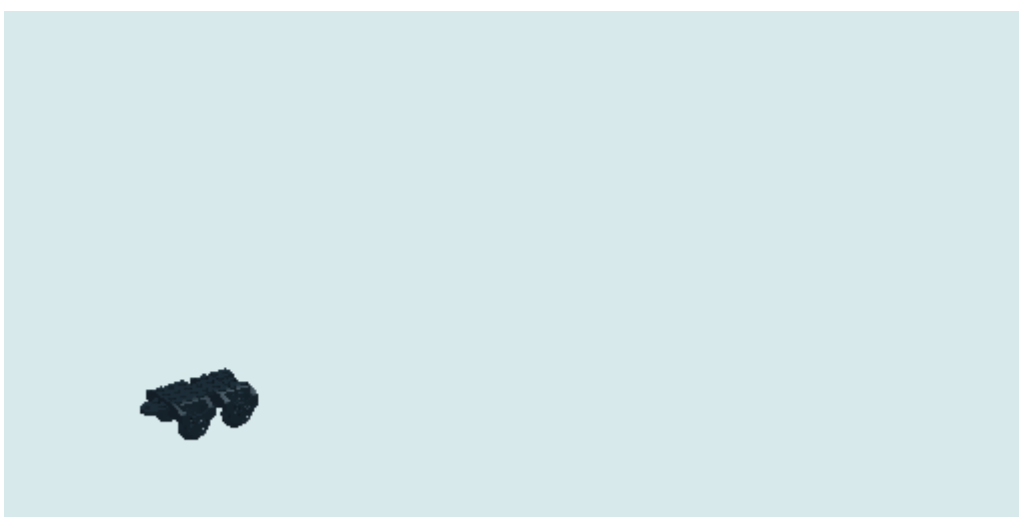

### Step 109

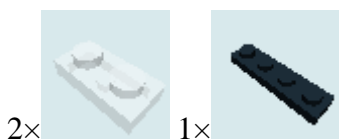

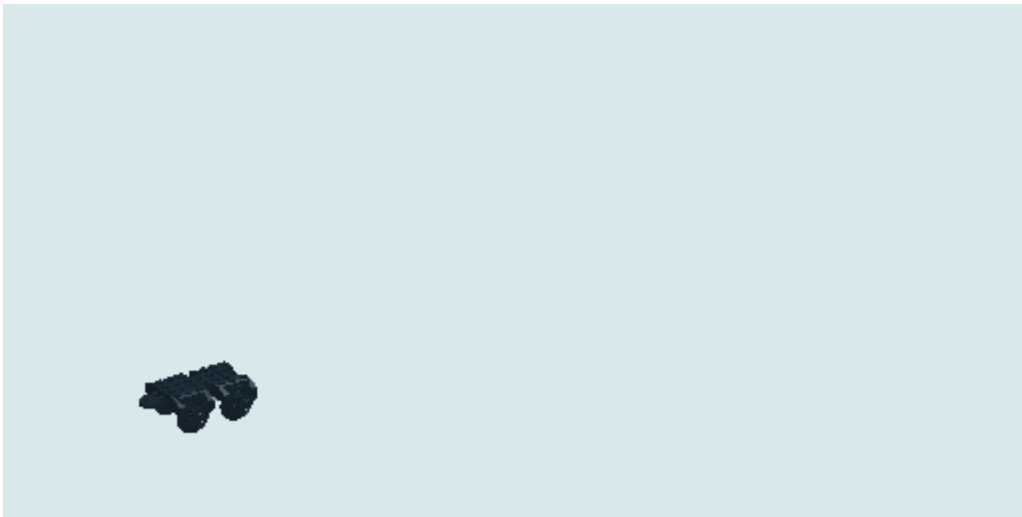

### Step 110



1x

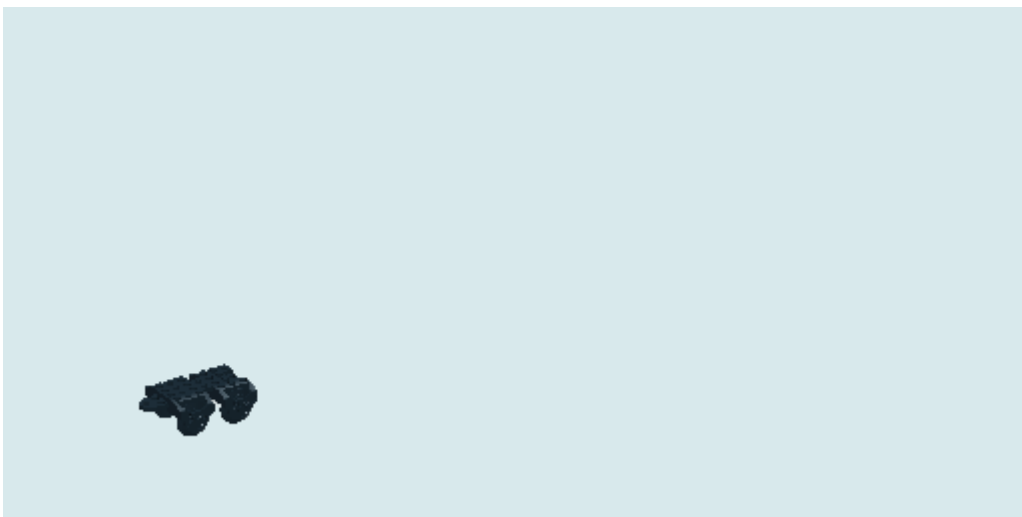

### Step 111



1x



2x

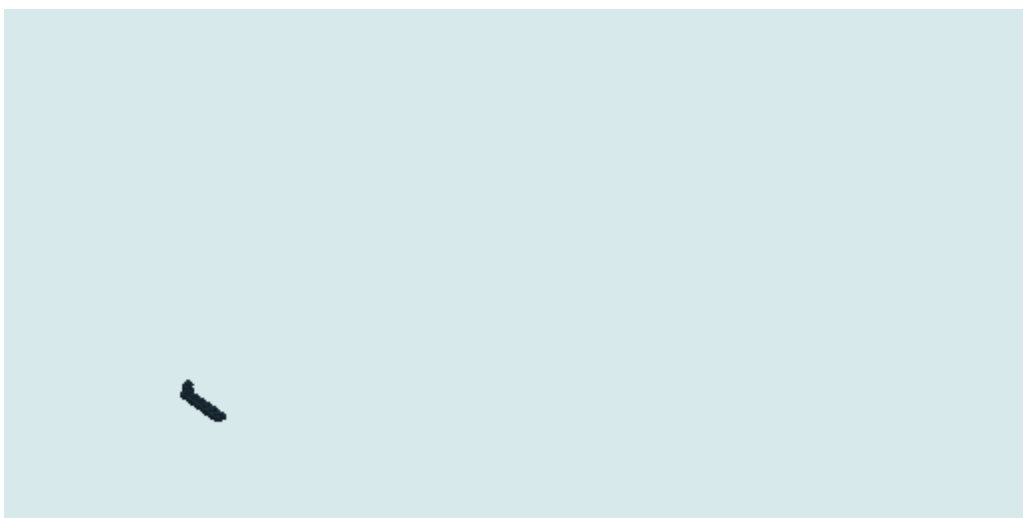

### Step 112

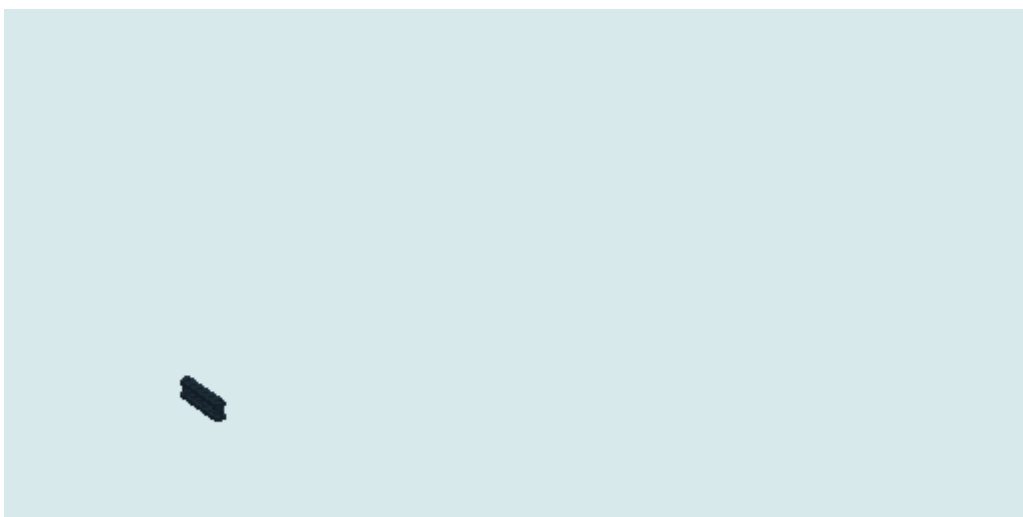
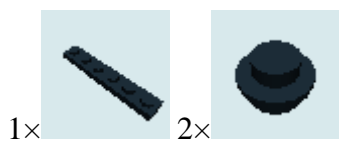

### Step 113

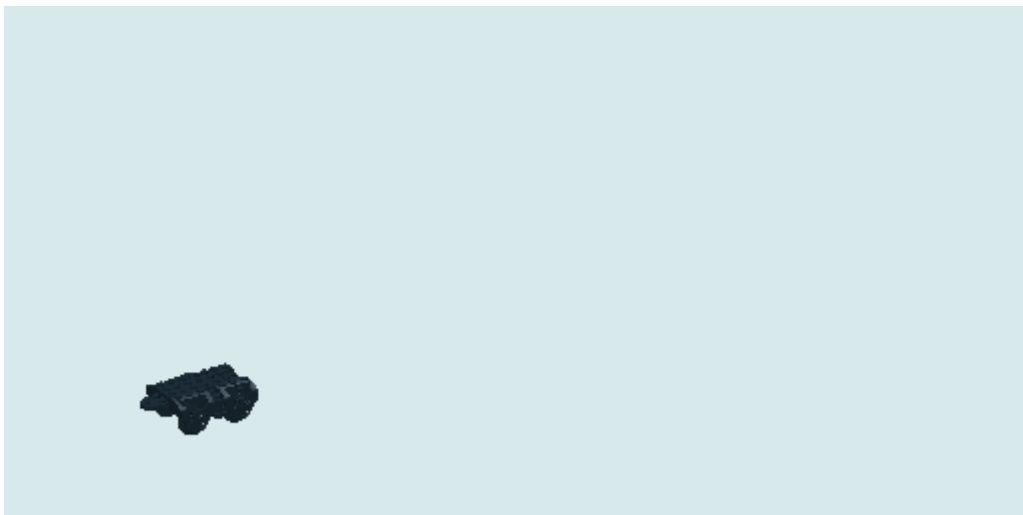

### Step 114

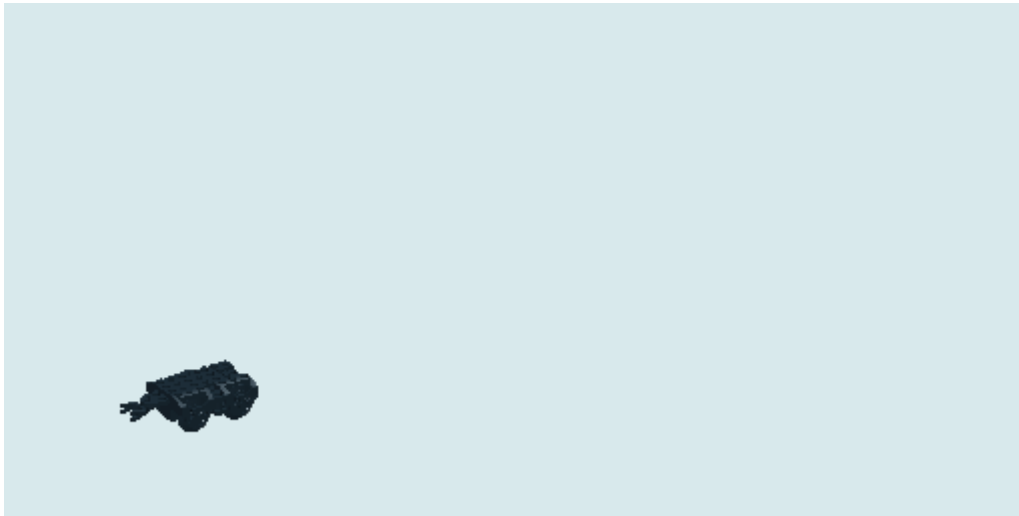
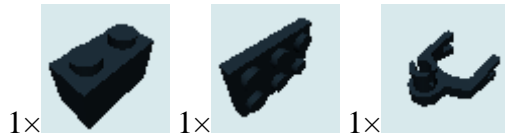

### Step 115

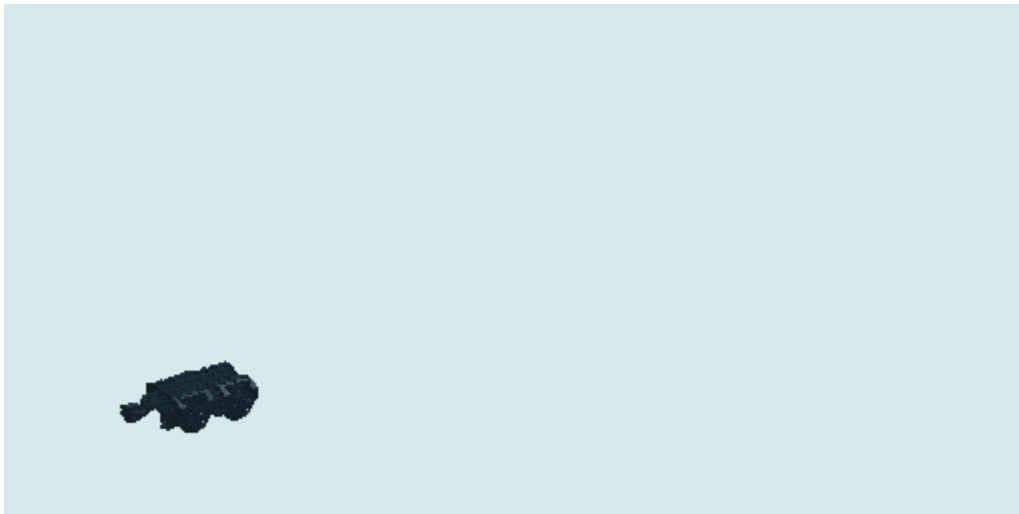
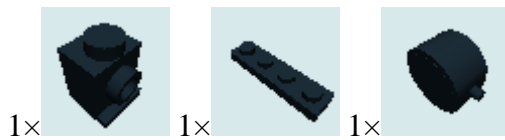

### Step 116

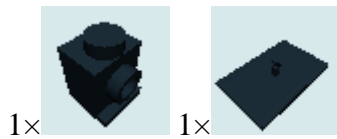

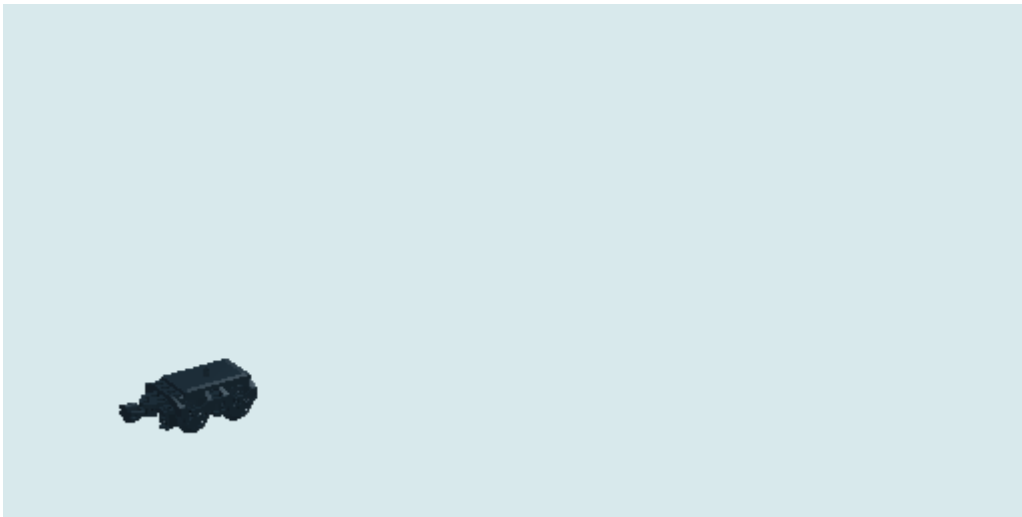

### Step 117

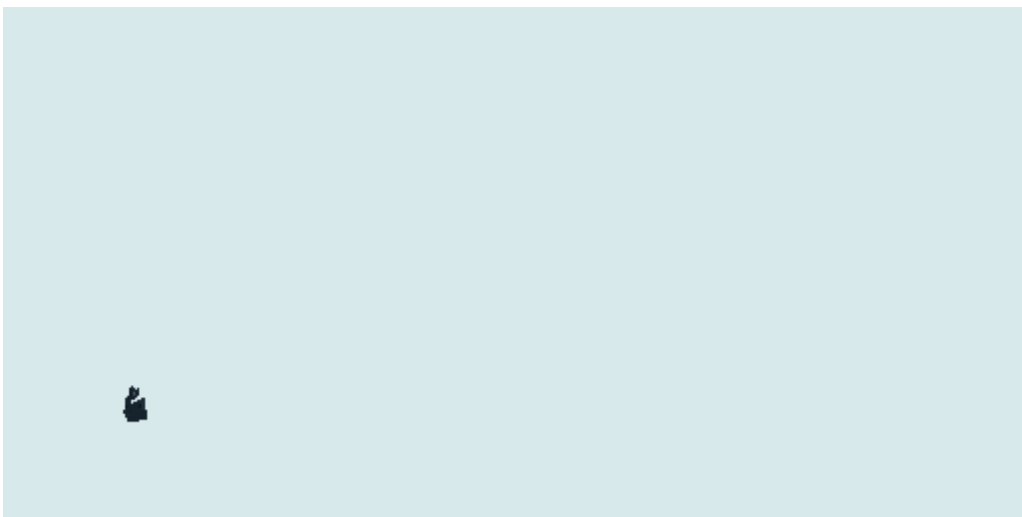
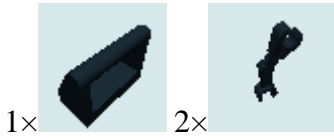

### Step 118



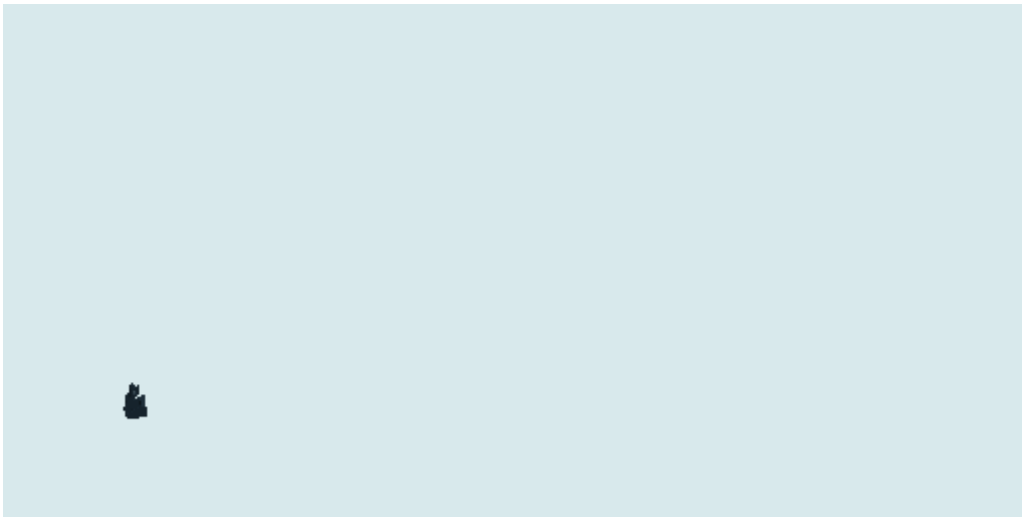

### Step 119

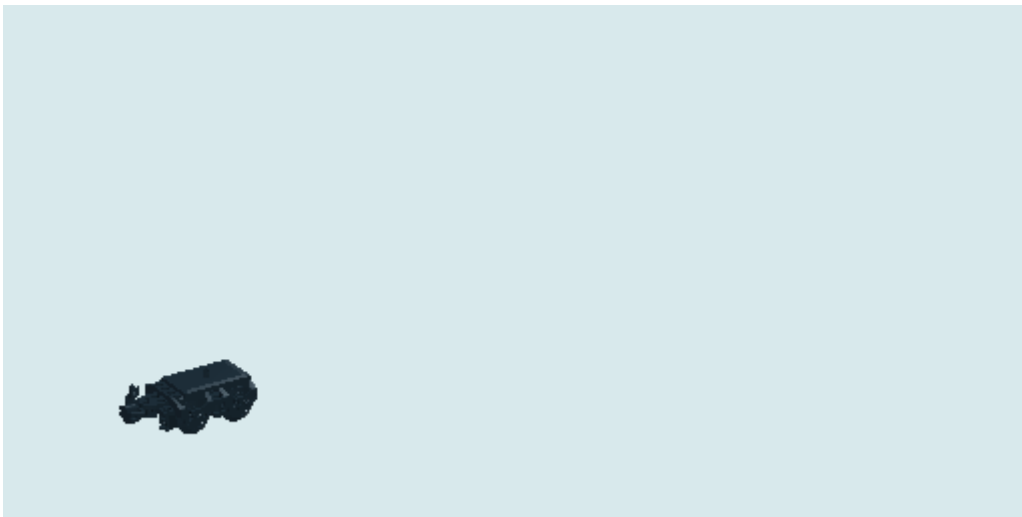

### Step 120

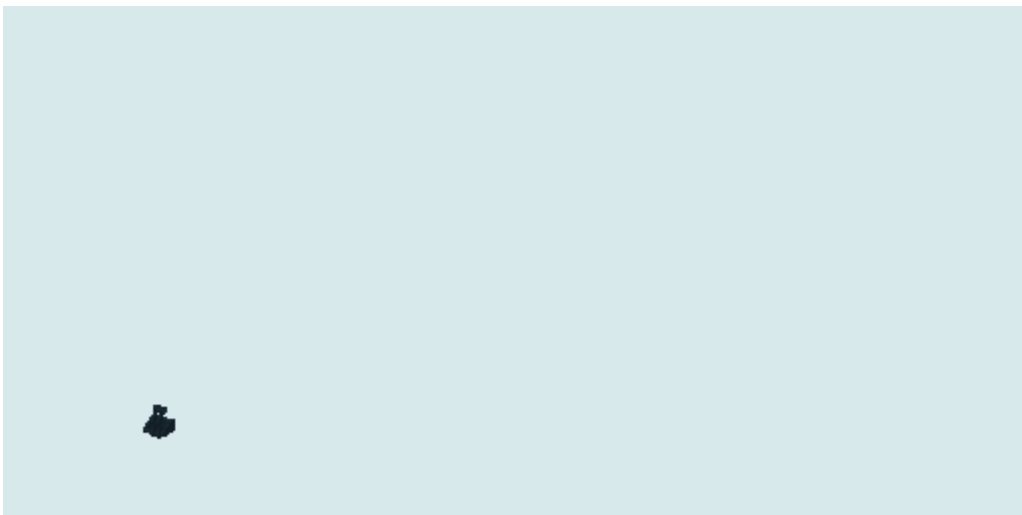
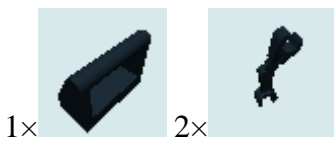

## Step 121

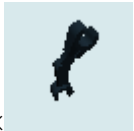

1x

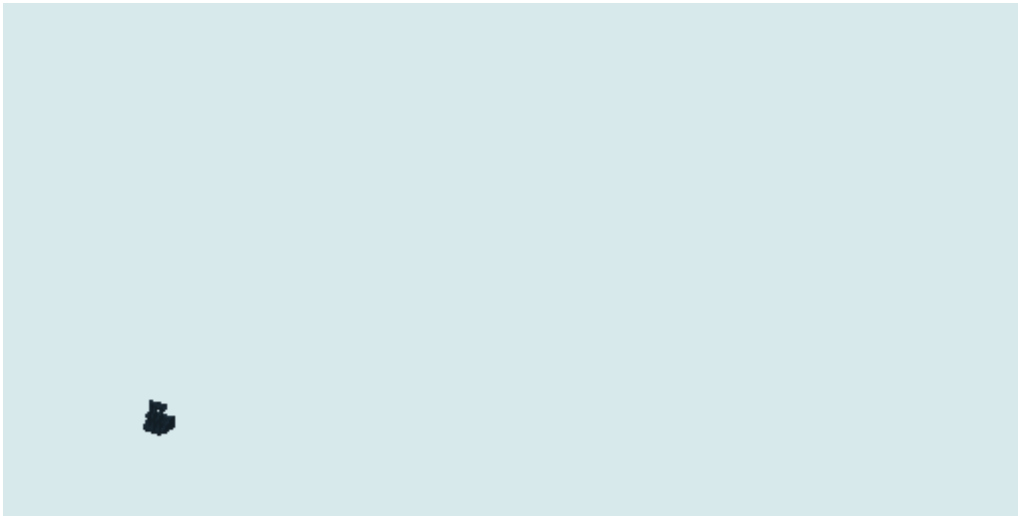

## Step 122

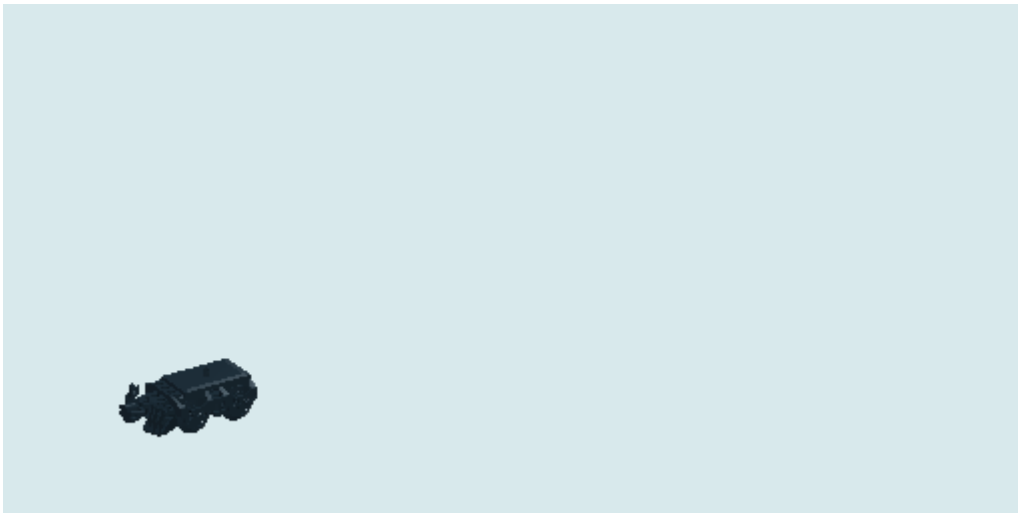

## Step 123



## Step 124

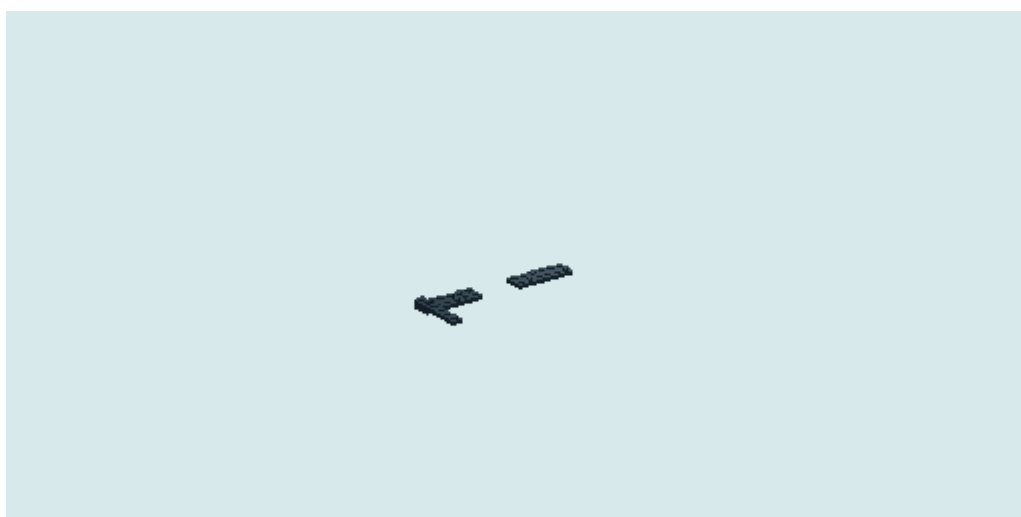
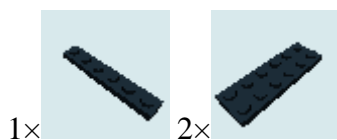

## Step 125

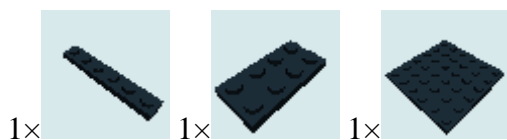

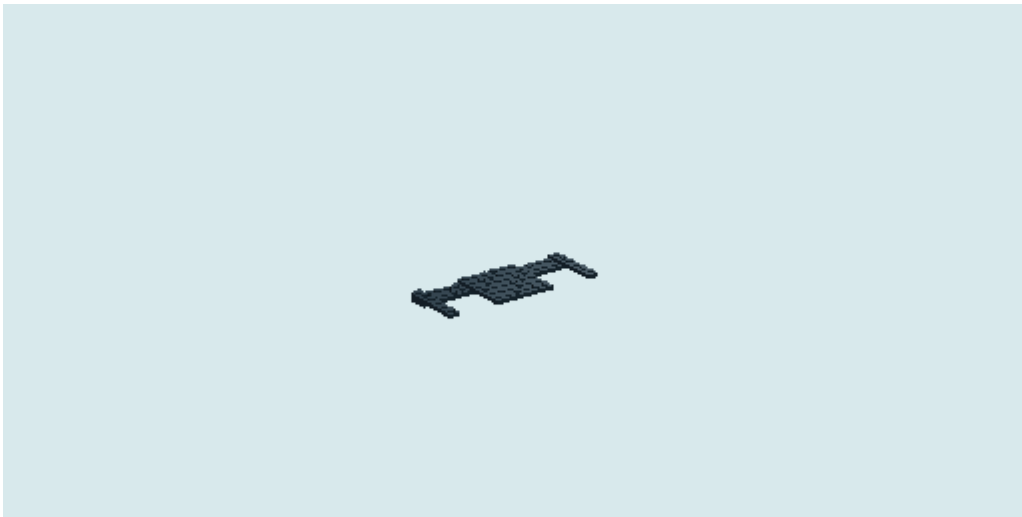

### Step 126

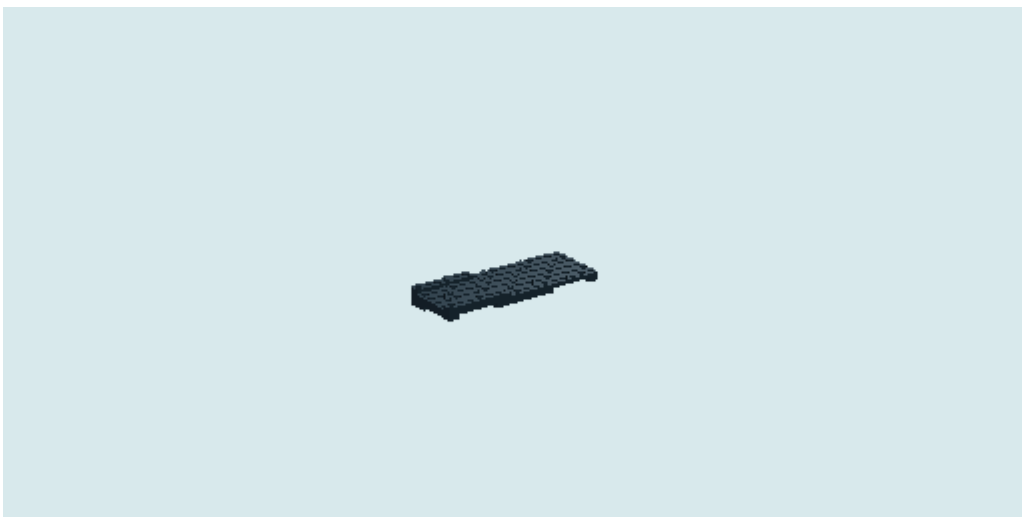
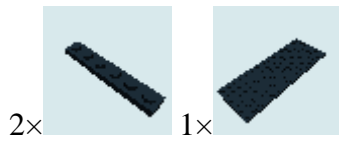

### Step 127

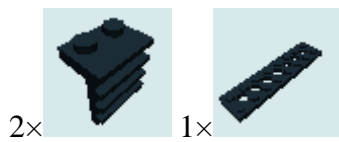

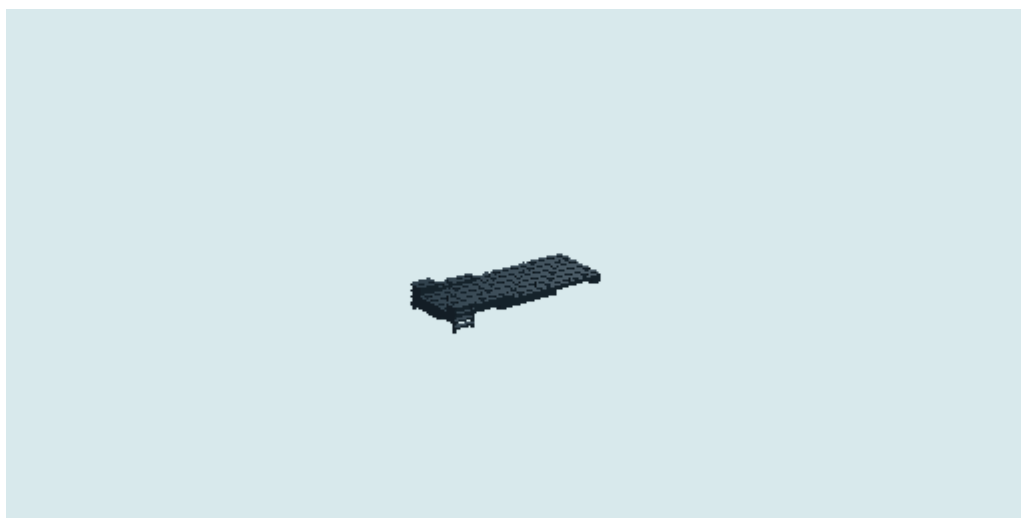

### Step 128

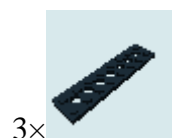

3x

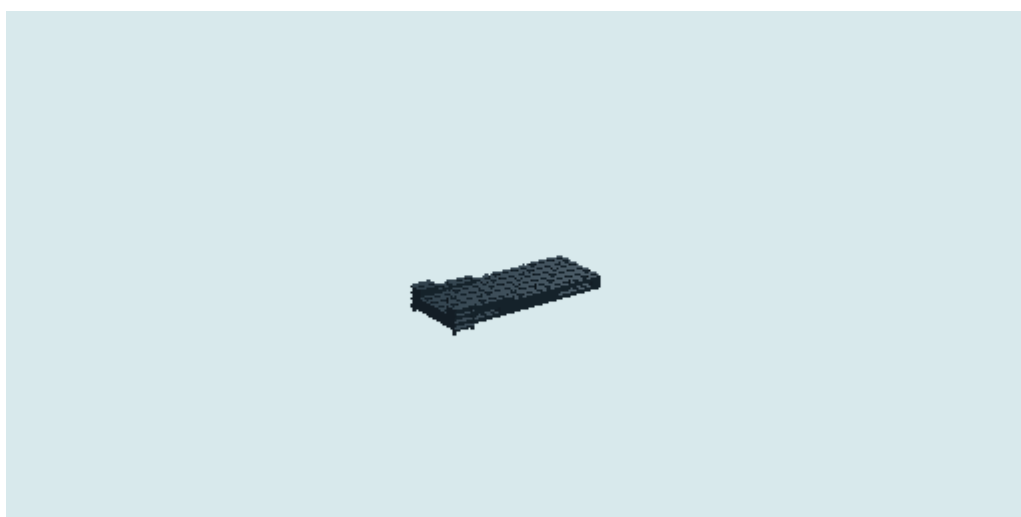

### Step 129

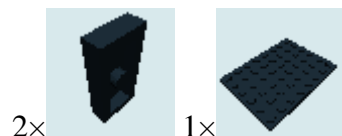

2x

1x

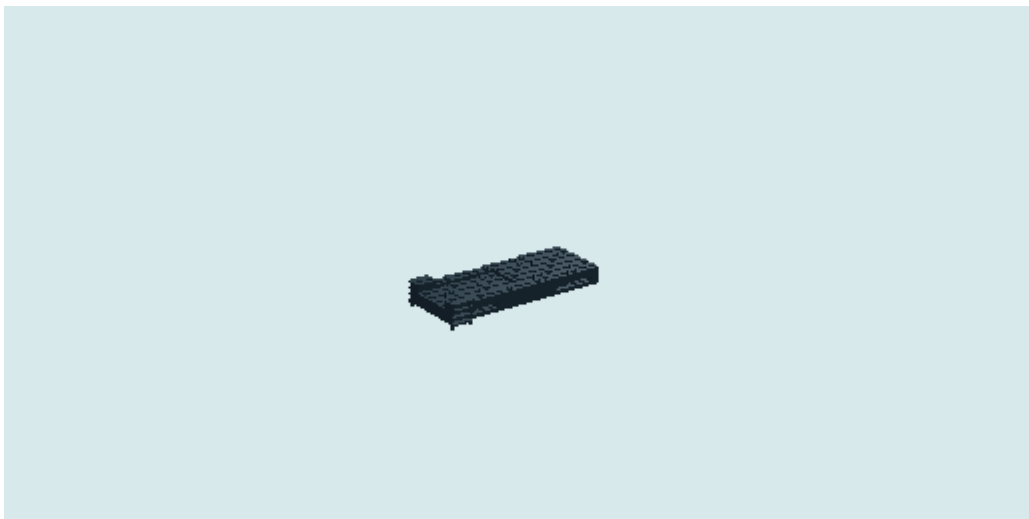

### Step 130

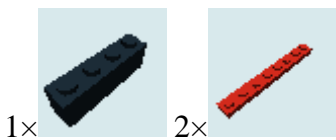

### Step 131

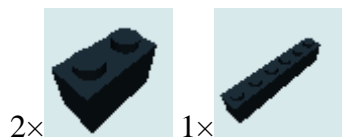

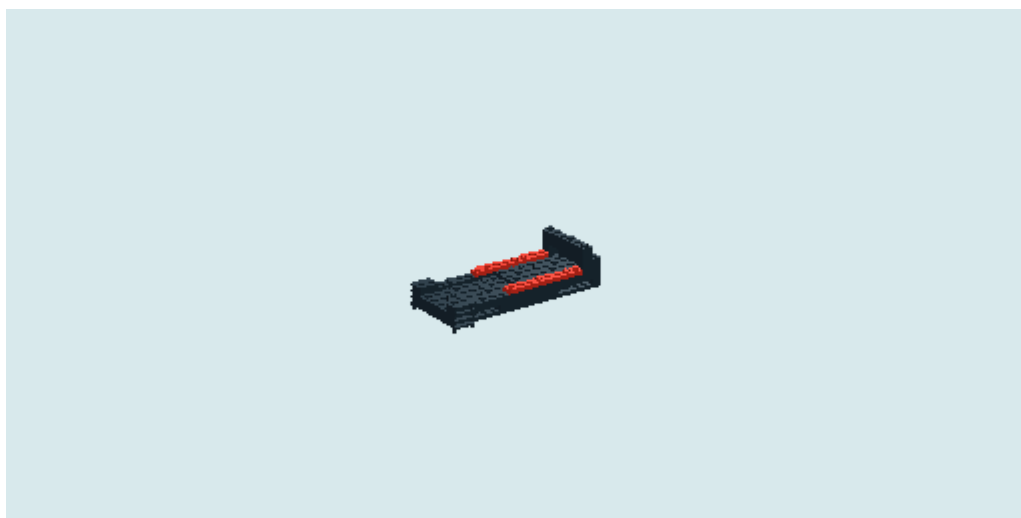

### Step 132

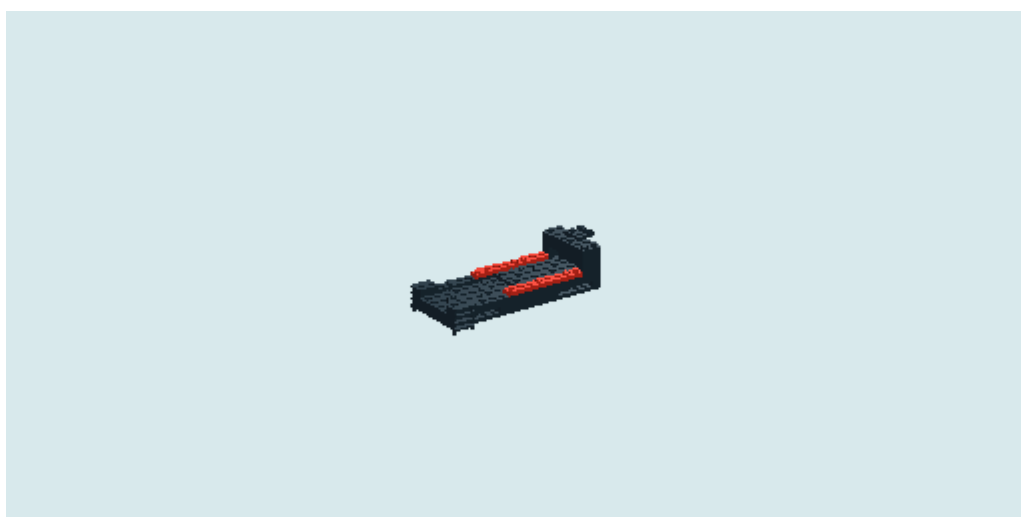
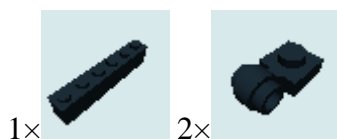

### Step 133

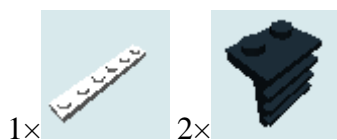



### Step 134

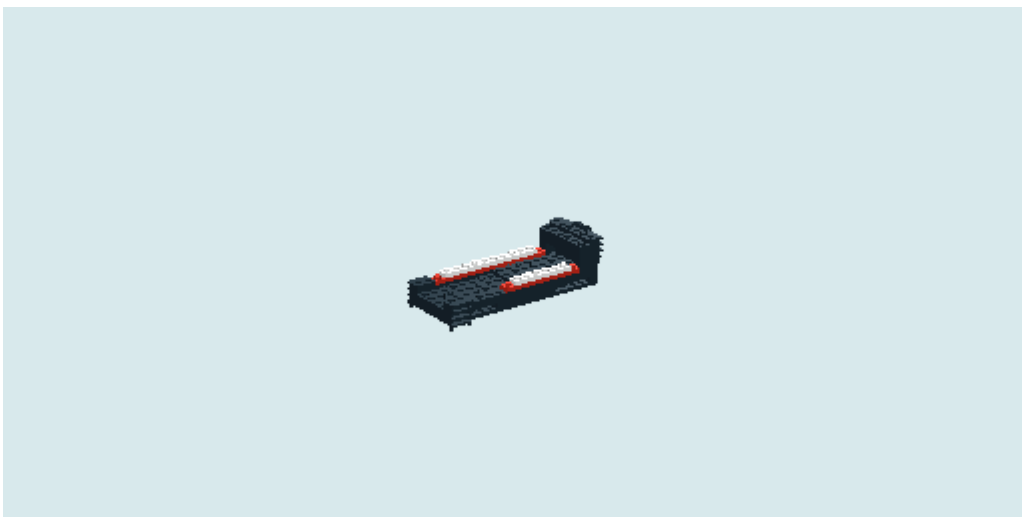
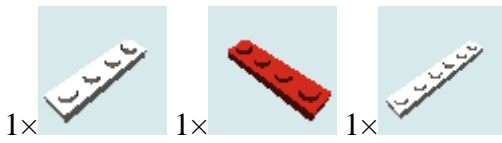

### Step 135

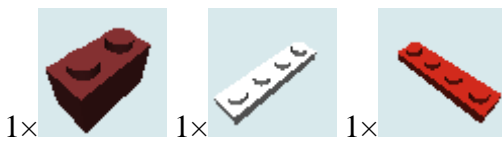

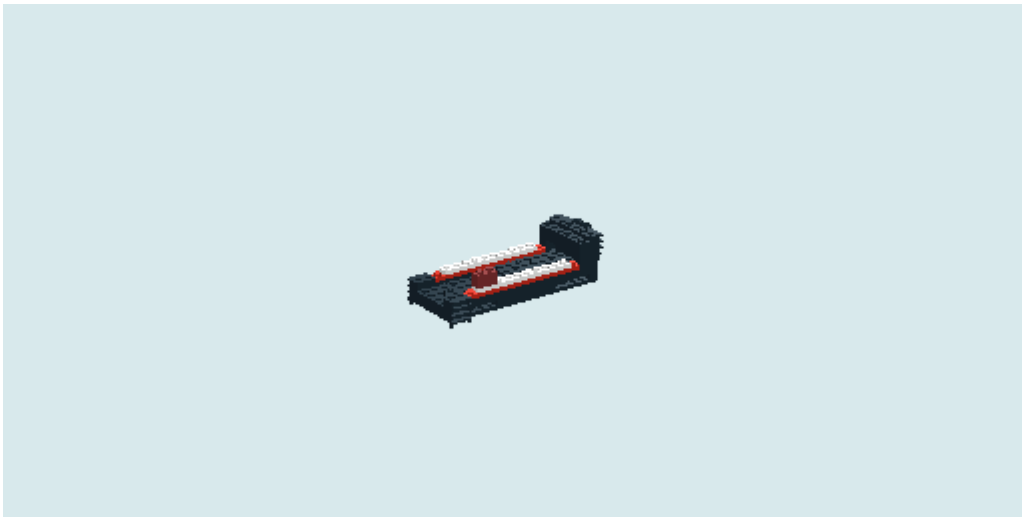

### Step 136



3x

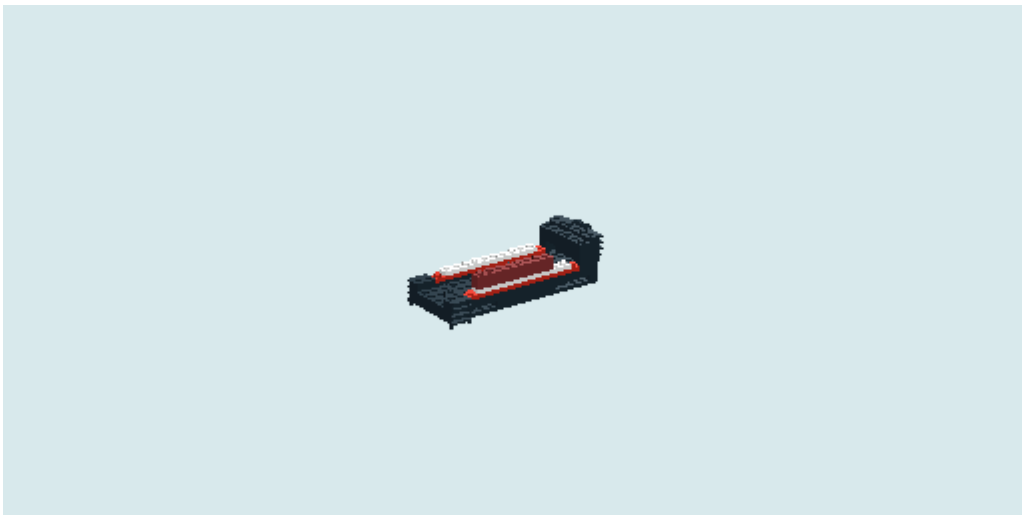

### Step 137



3x



### Step 138



3x



### Step 139



2x



1x

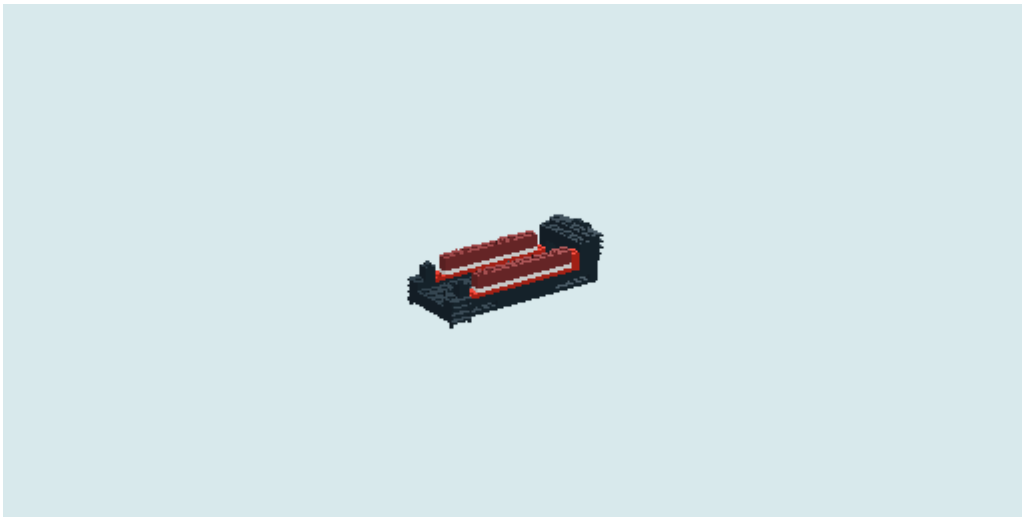

### Step 140



3x

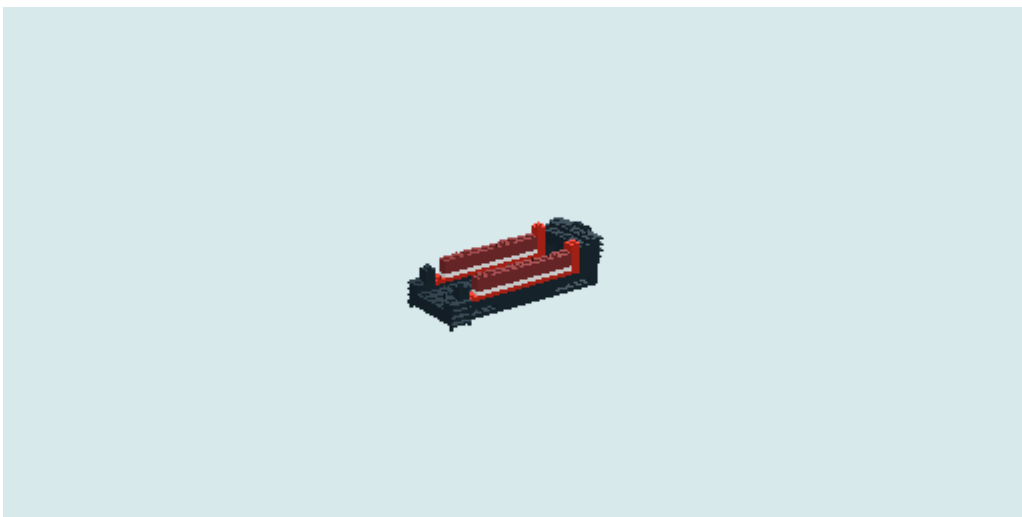

### Step 141



2x

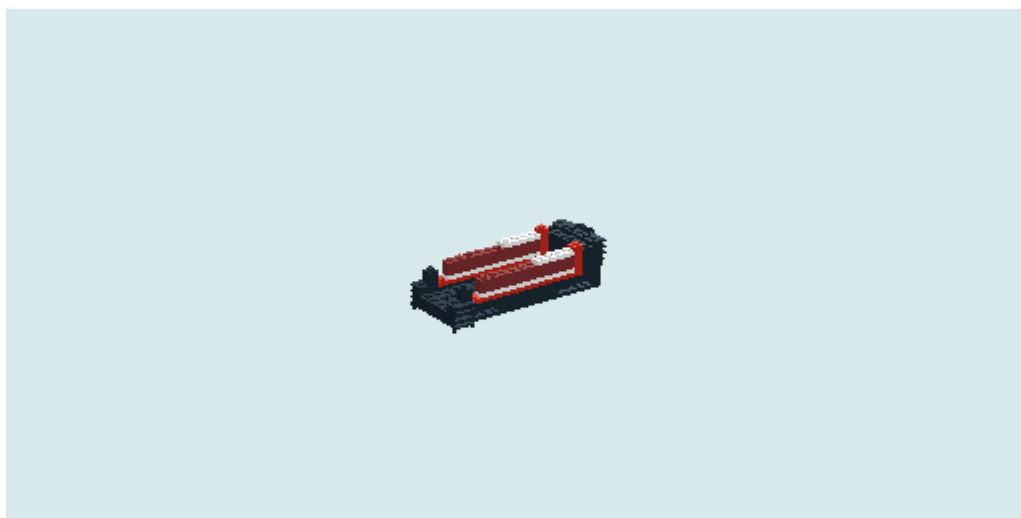

### Step 142

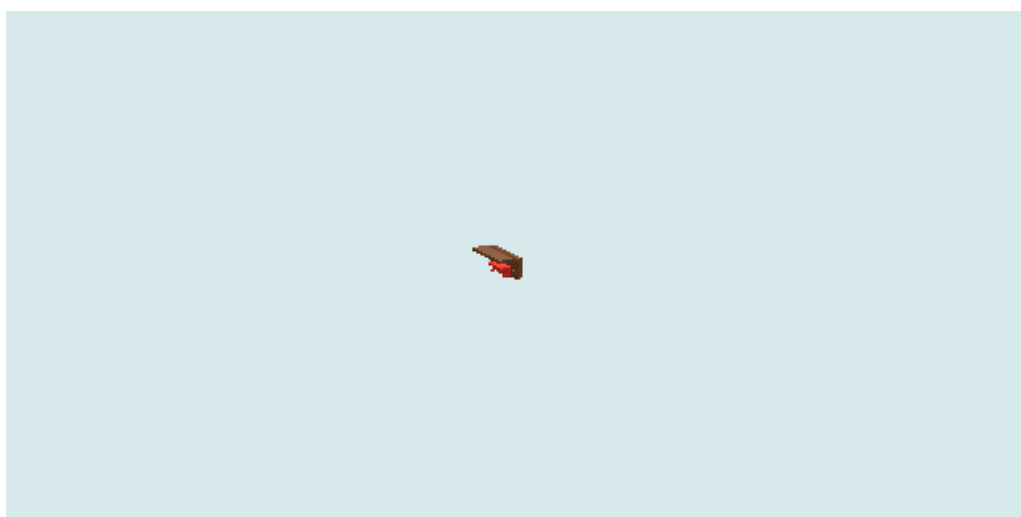
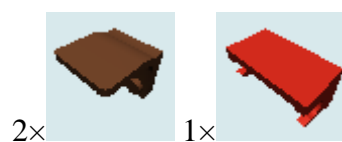

### Step 143

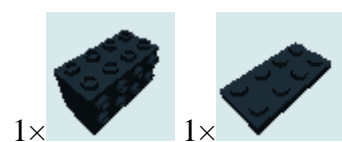

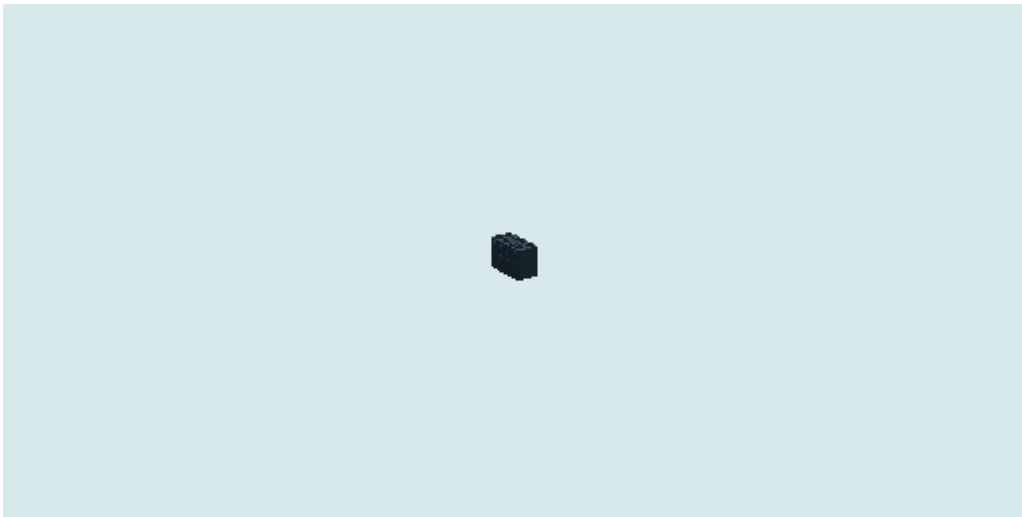

### Step 144

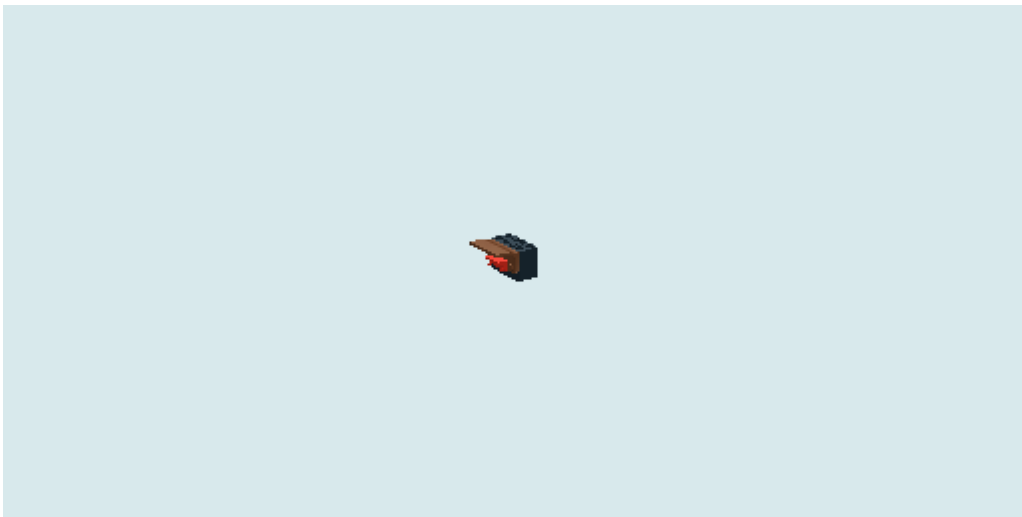

### Step 145

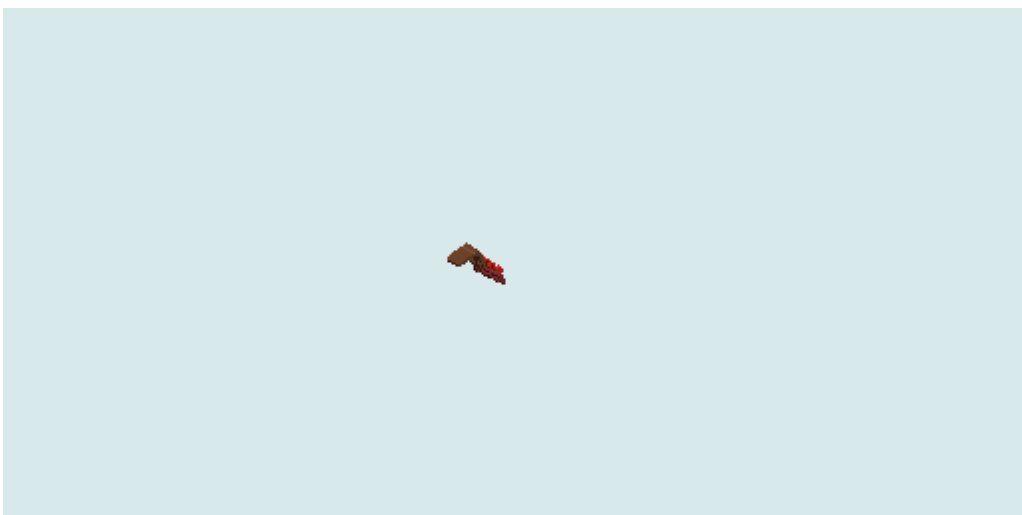

### Step 146

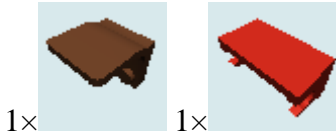

### Step 147

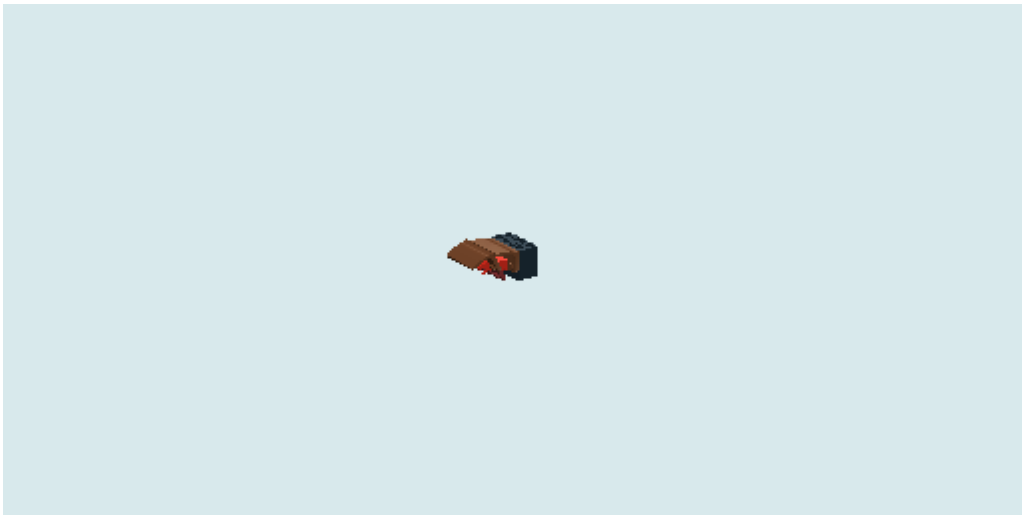

### Step 148

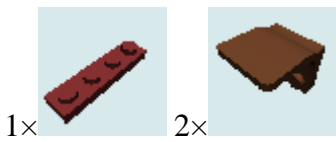



### Step 149

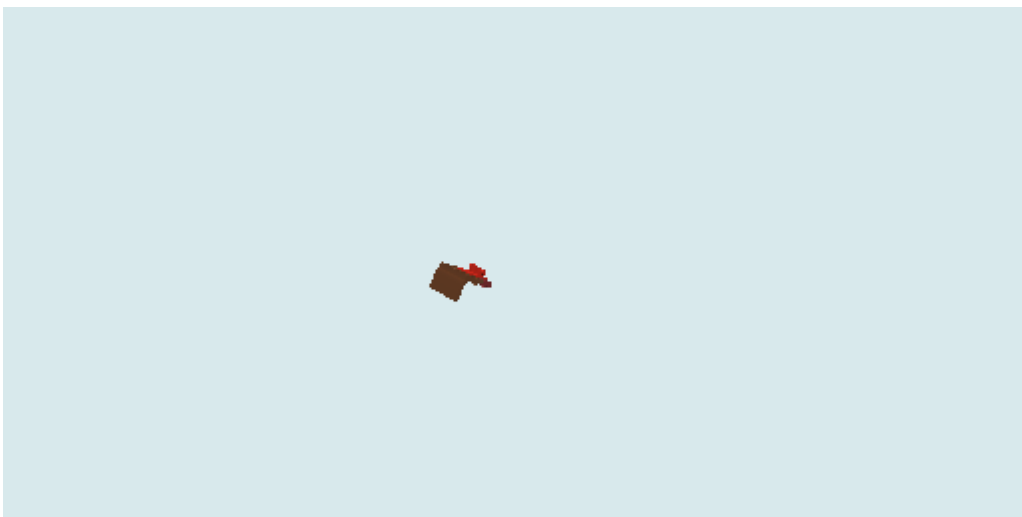

### Step 150

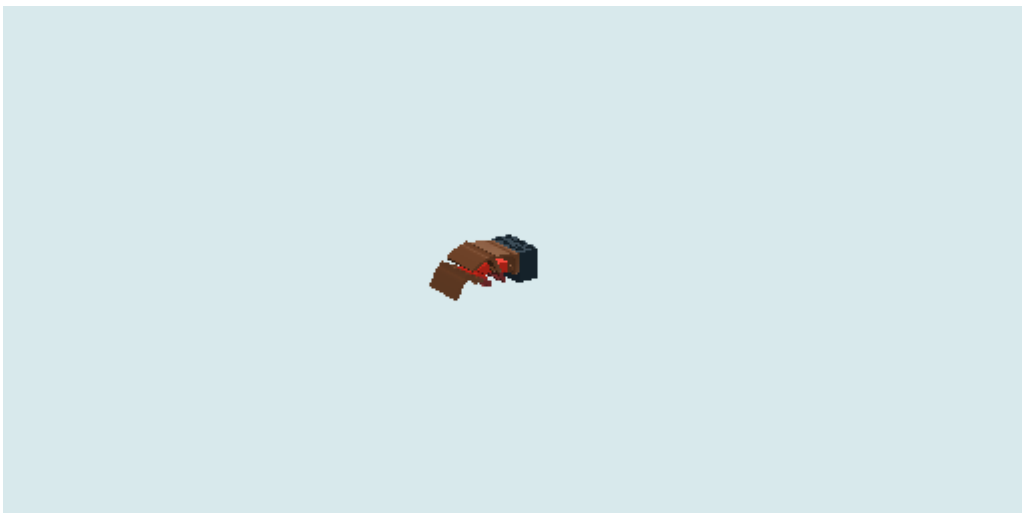

### Step 151



### Step 152



### Step 153





### Step 154

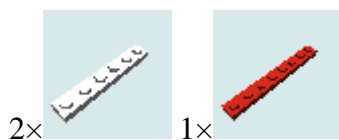

### Step 155

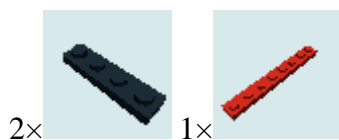



### Step 156



### Step 157





### Step 158

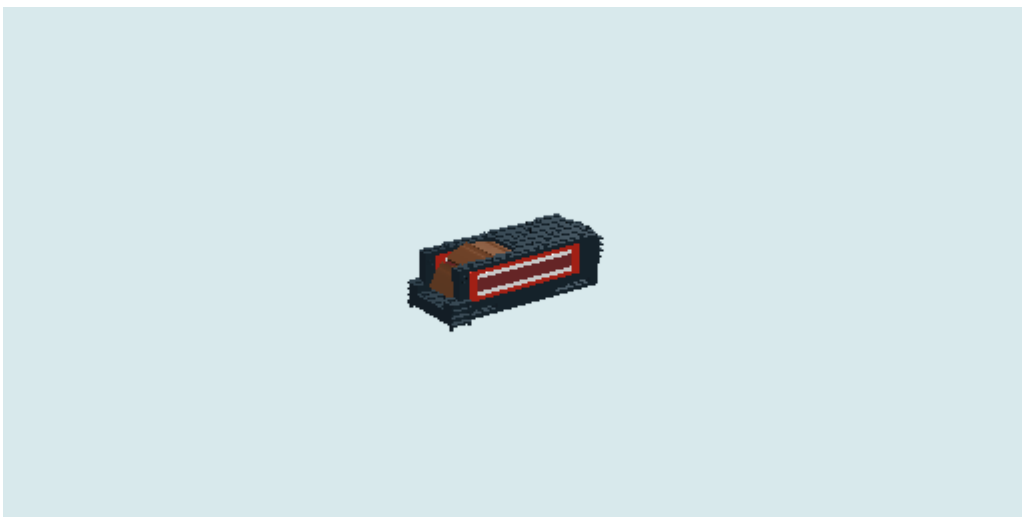

### Step 159

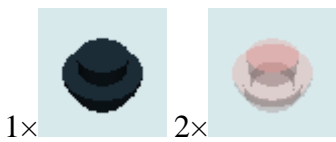

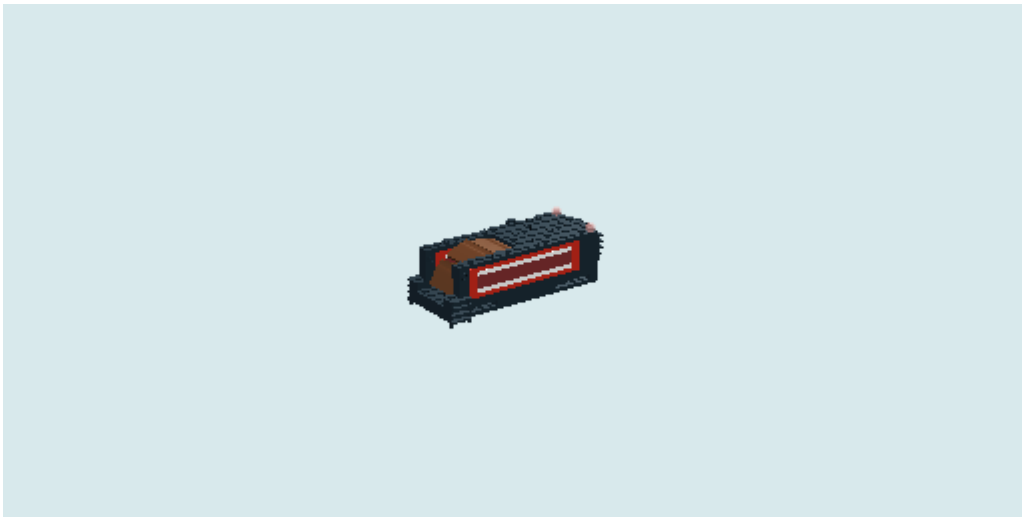

### Step 160

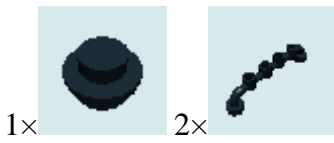

### Step 161





### Step 162



### Step 163

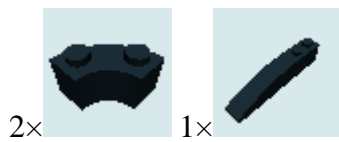



### Step 164



### Step 165

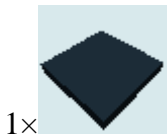

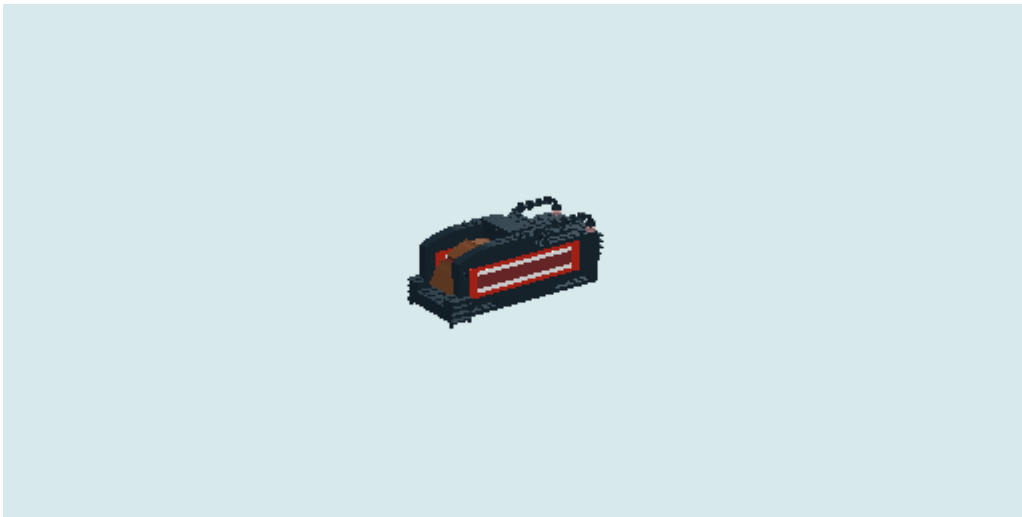

### Step 166

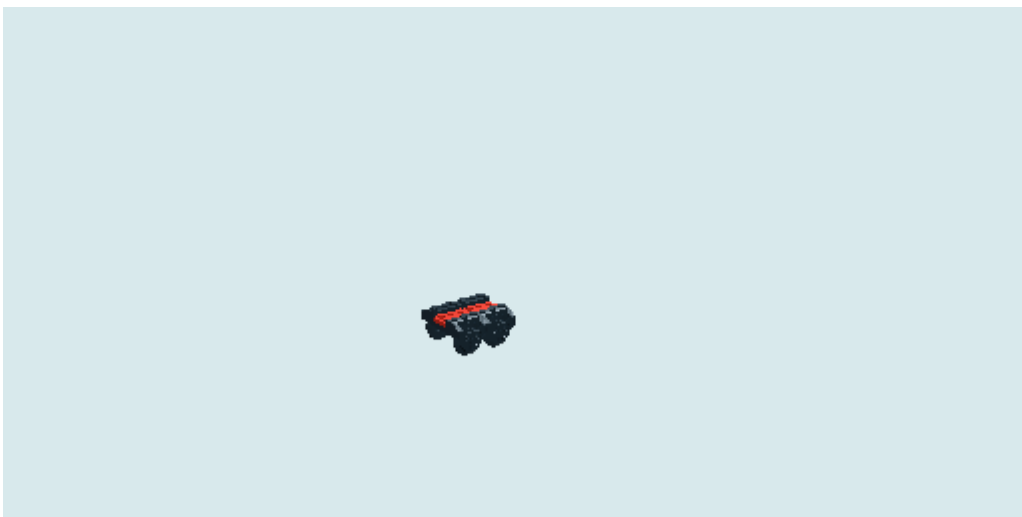
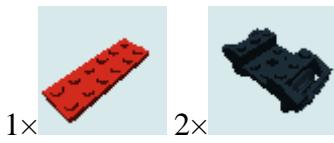

### Step 167



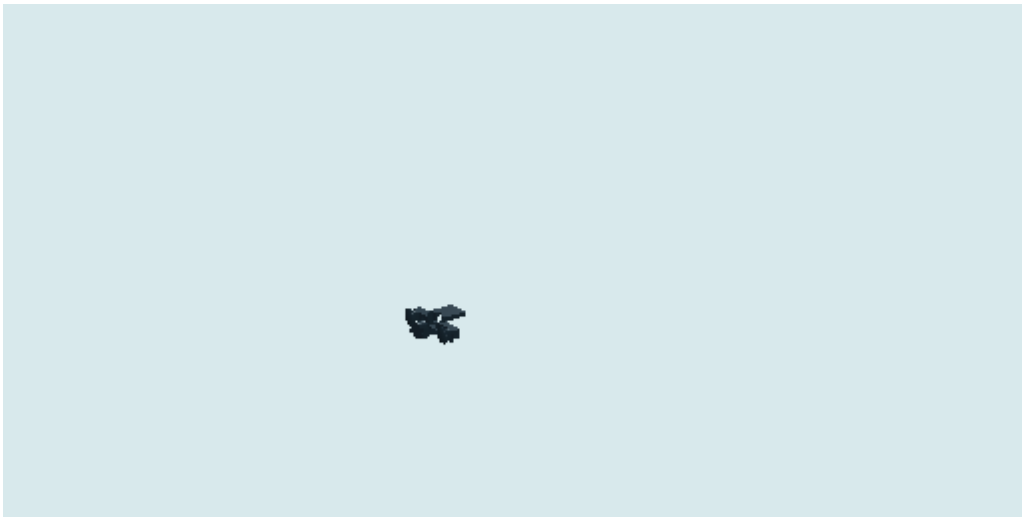

### Step 168

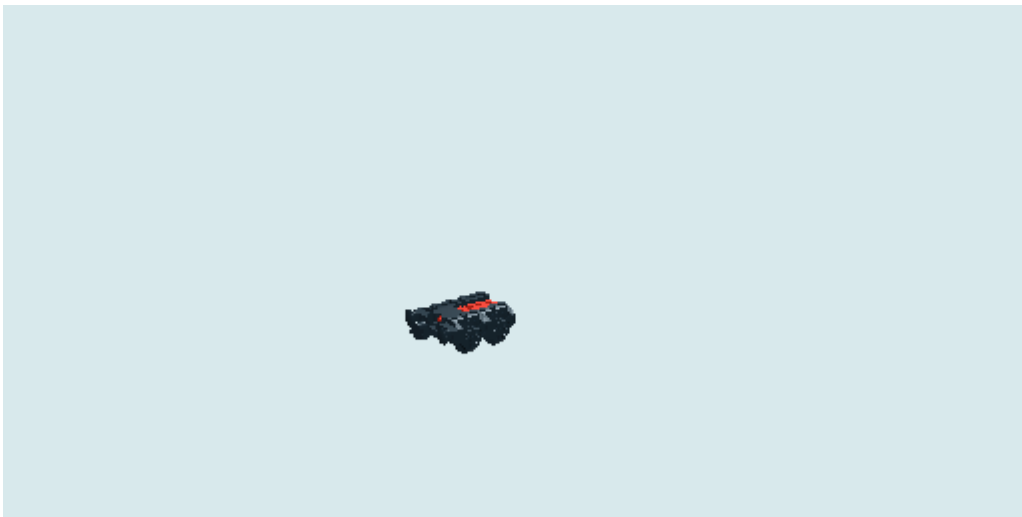

### Step 169

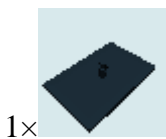

## Step 170



## Step 171

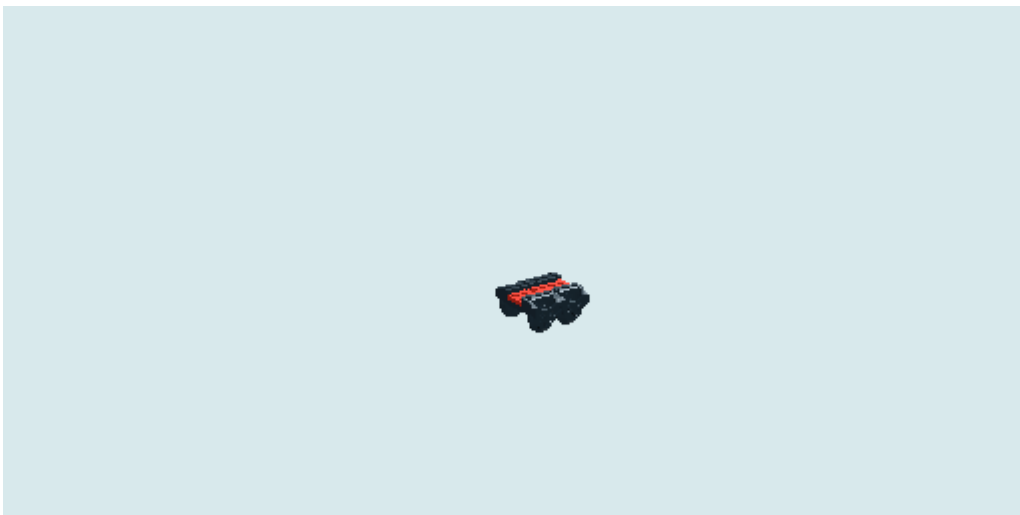
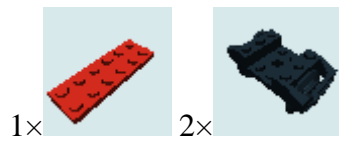

## Step 172



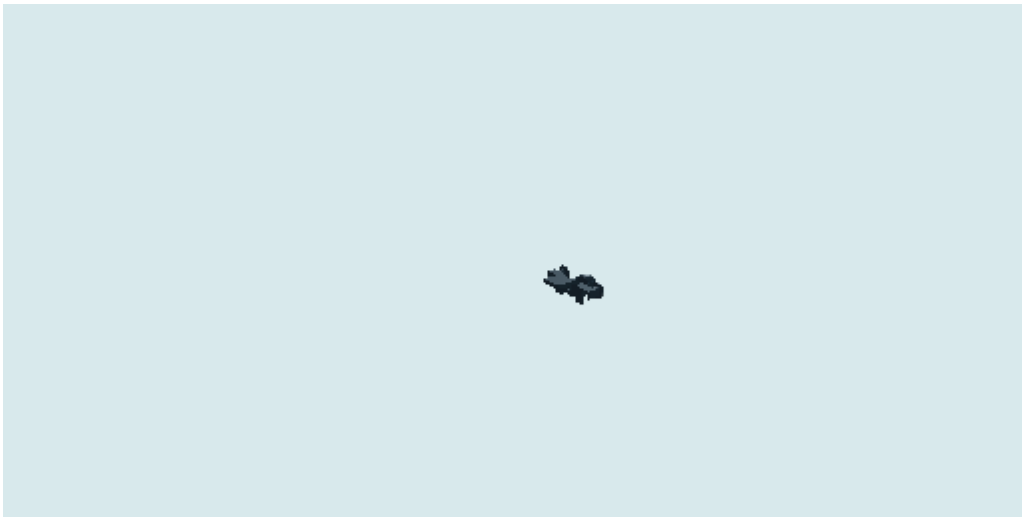

### Step 173

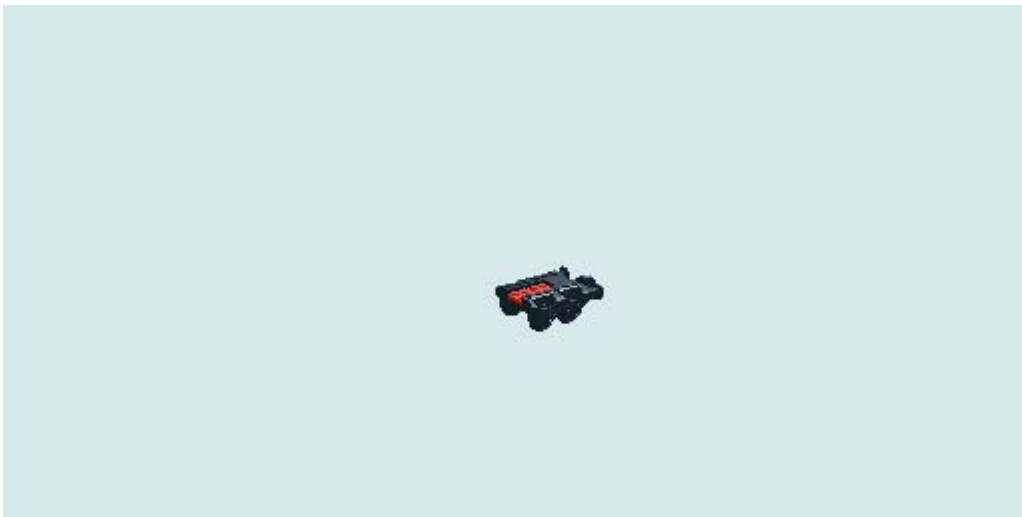

### Step 174

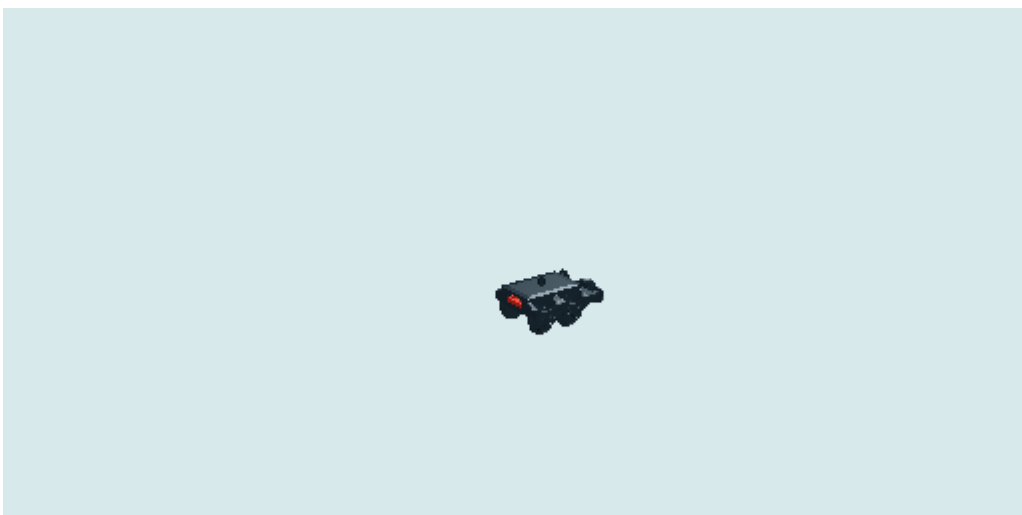
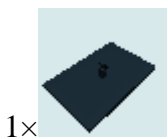

### Step 175



### Step 176



### Step 177





### Step 178

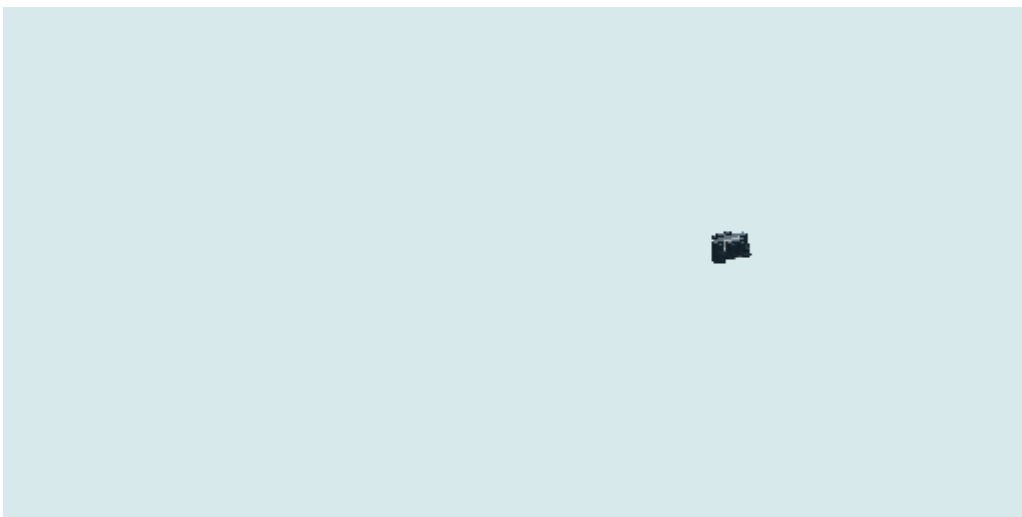

### Step 179

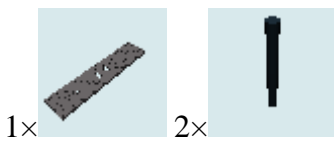



### Step 180

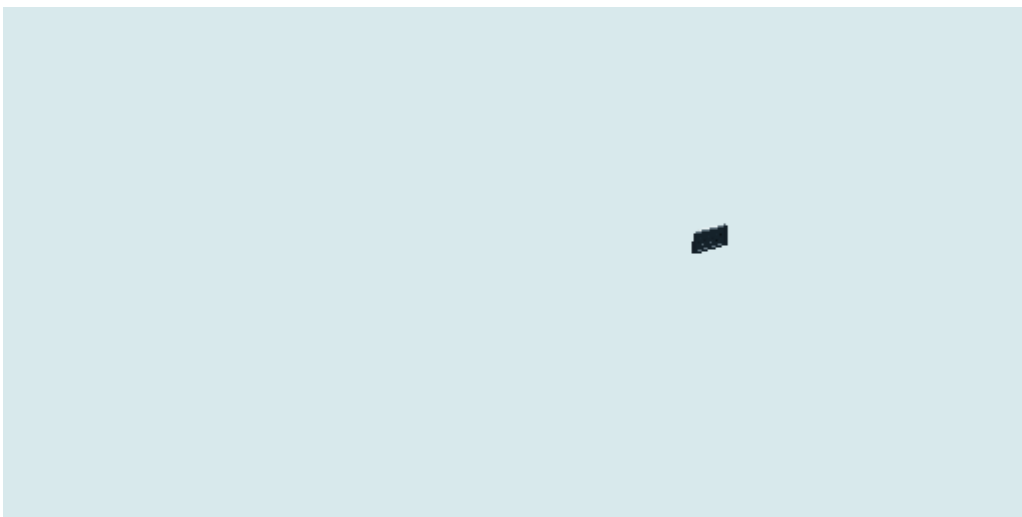
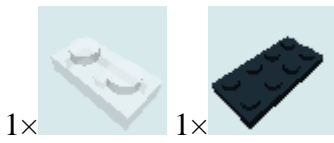

### Step 181

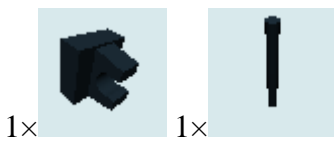



### Step 182

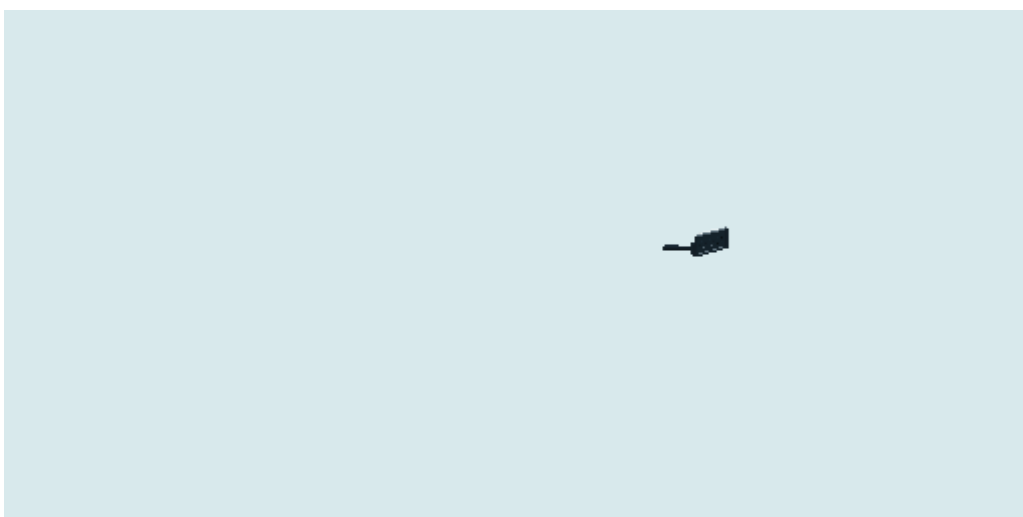

### Step 183

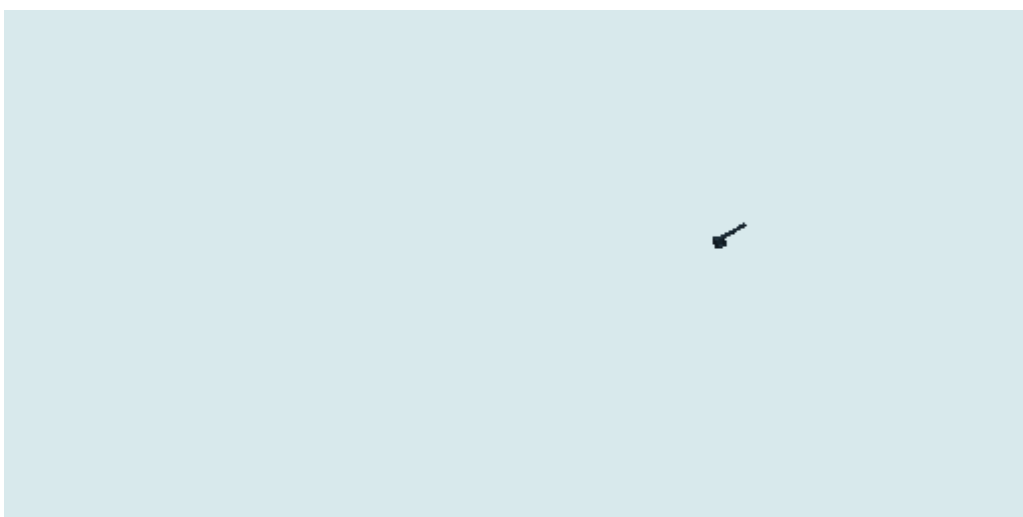
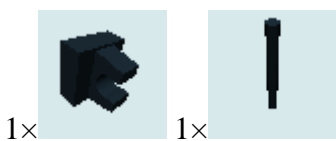

## Step 184

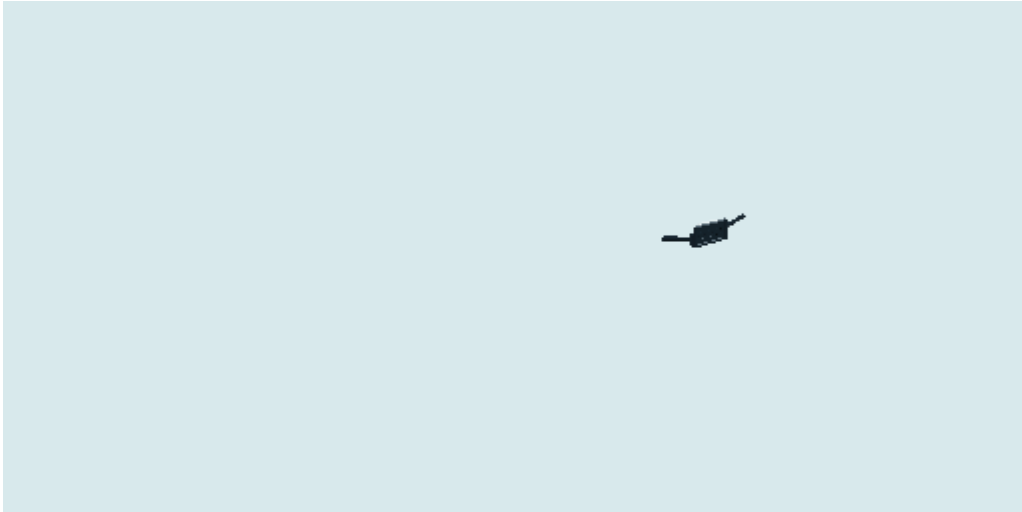

## Step 185

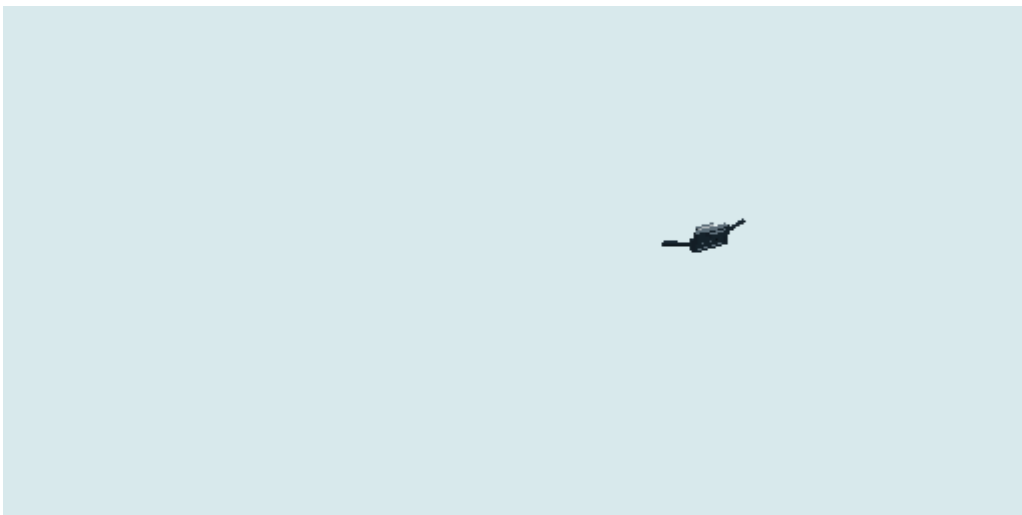
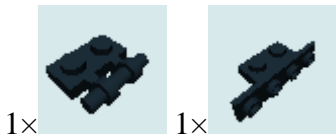

## Step 186

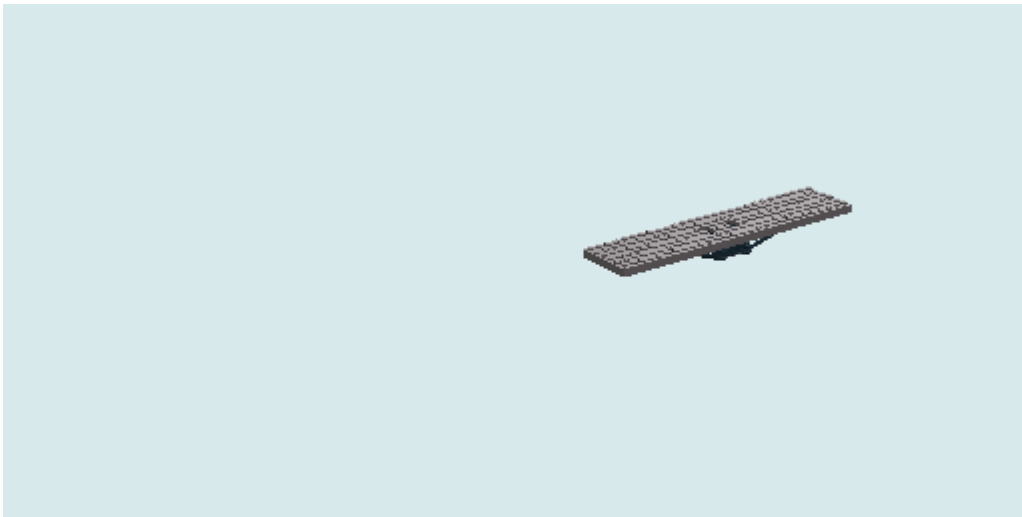

### Step 187

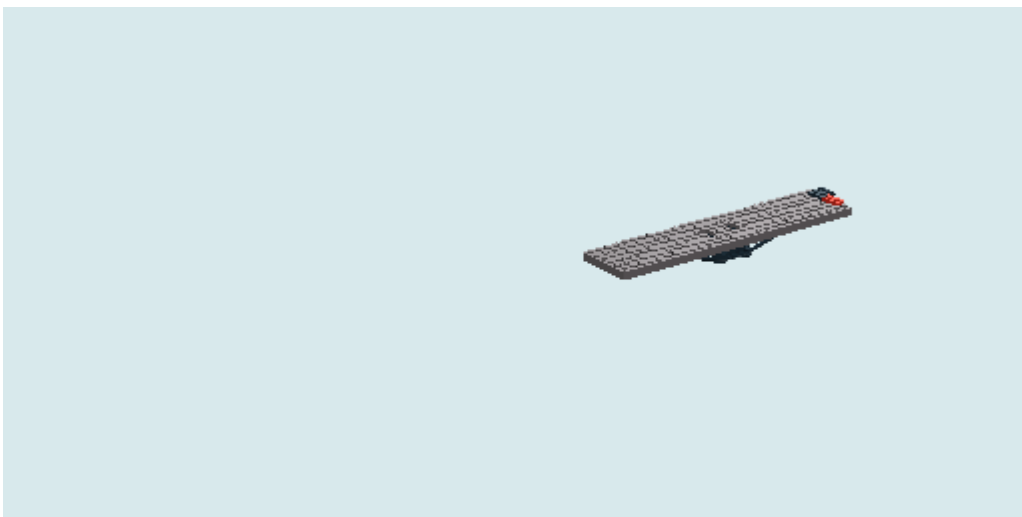

### Step 188

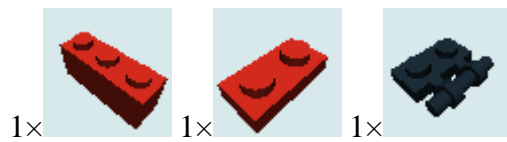



### Step 189

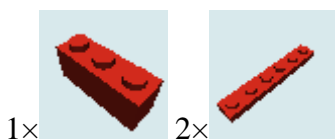

### Step 190

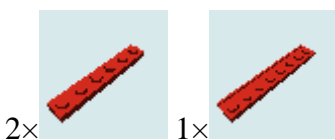



### Step 191

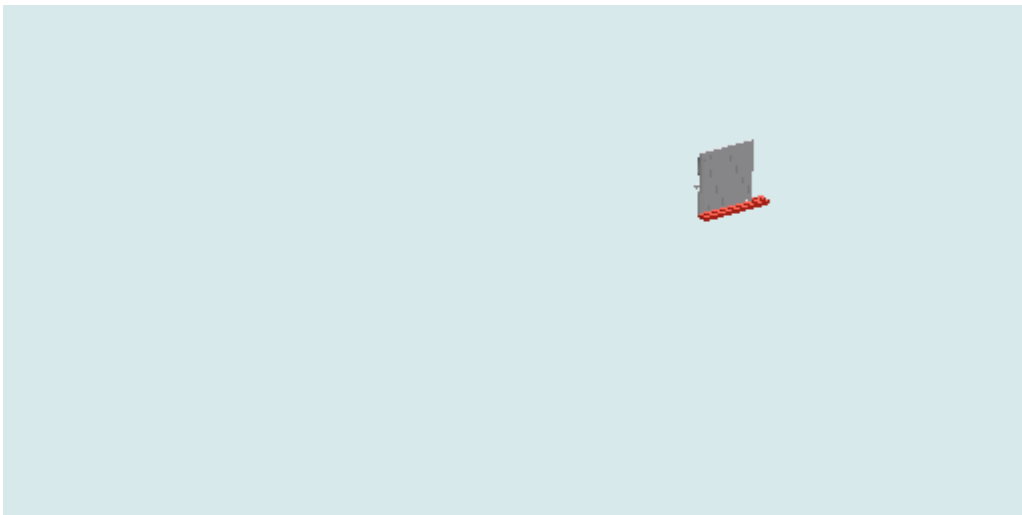
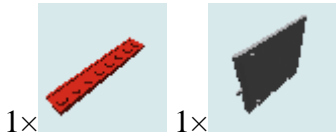

### Step 192



### Step 193

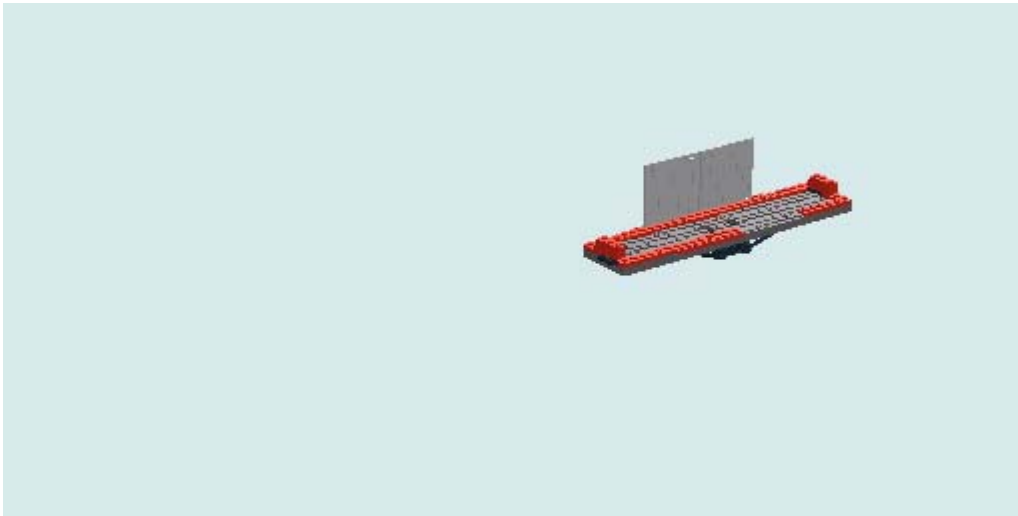
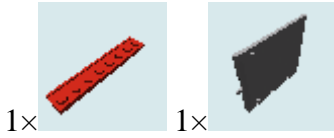

### Step 194

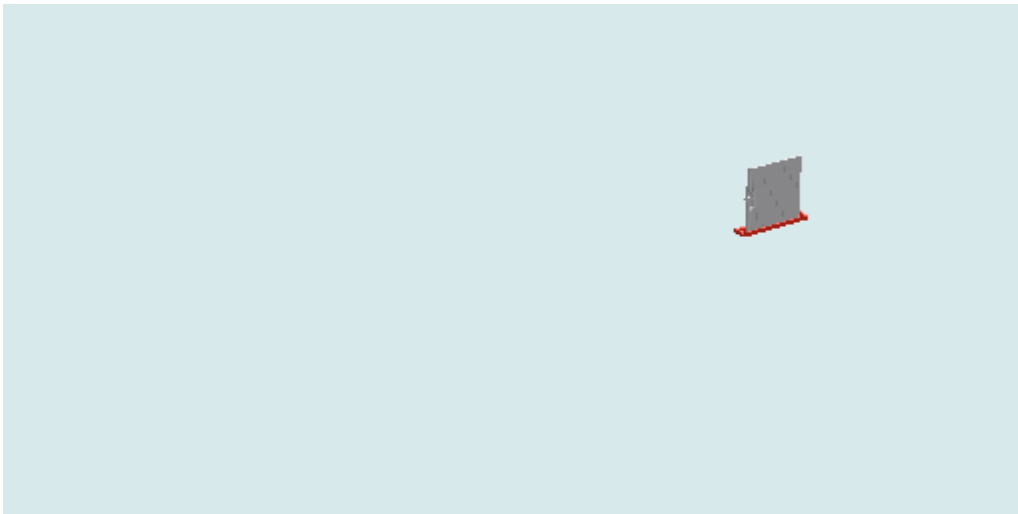
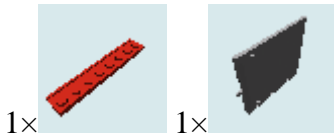

### Step 195



### Step 196

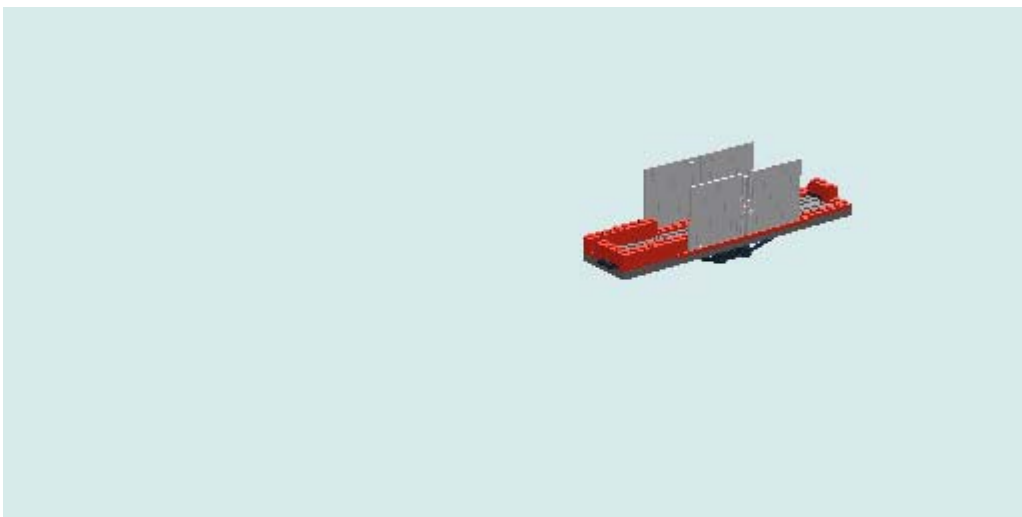
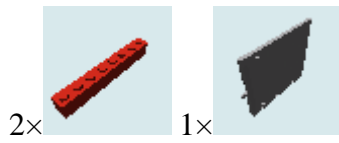

### Step 197

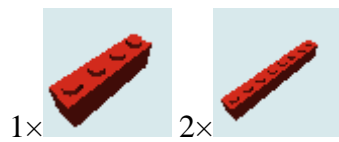

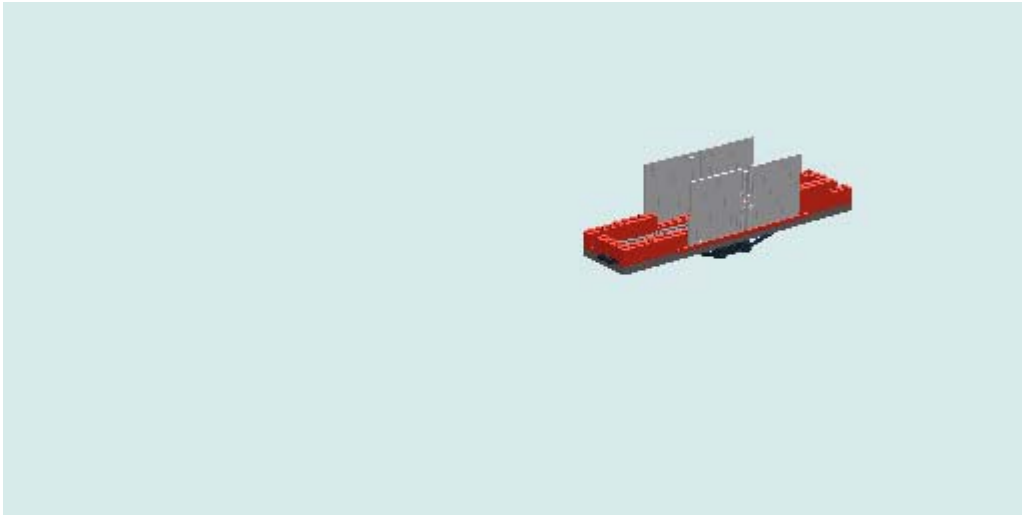

### Step 198

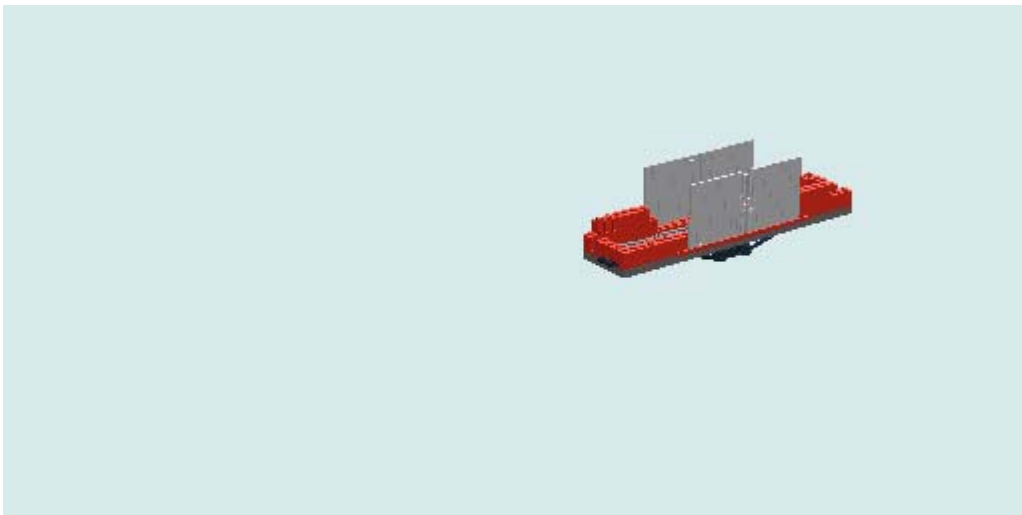
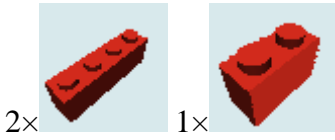

### Step 199



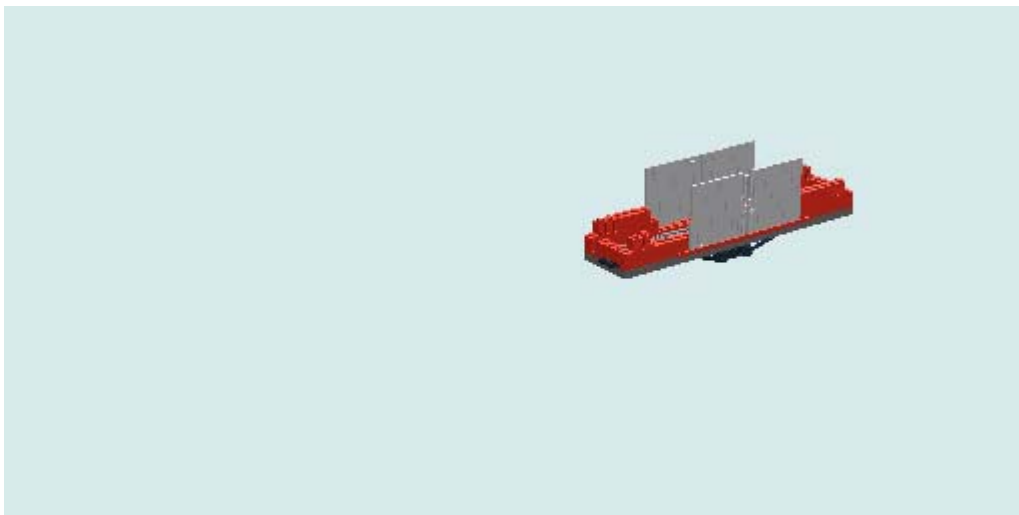

### Step 200



3x

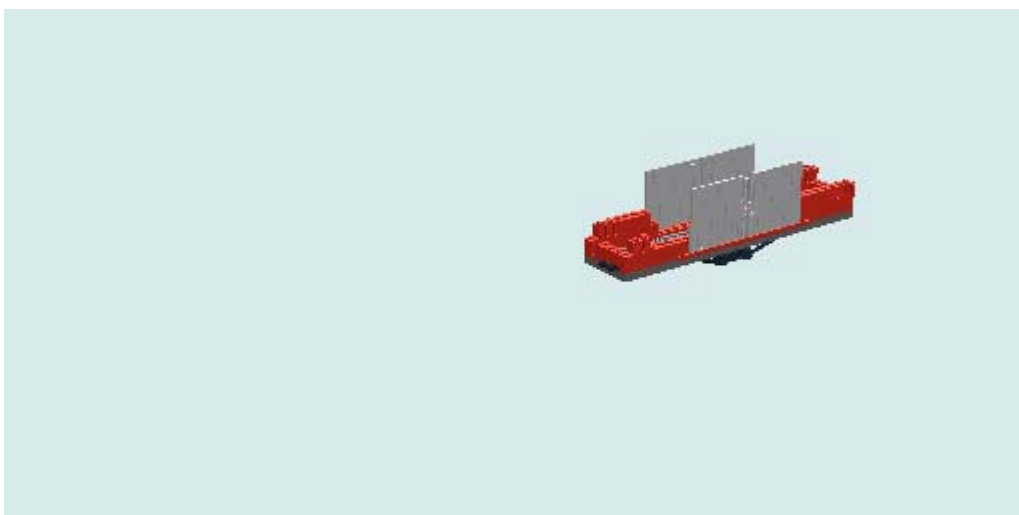

### Step 201



3x

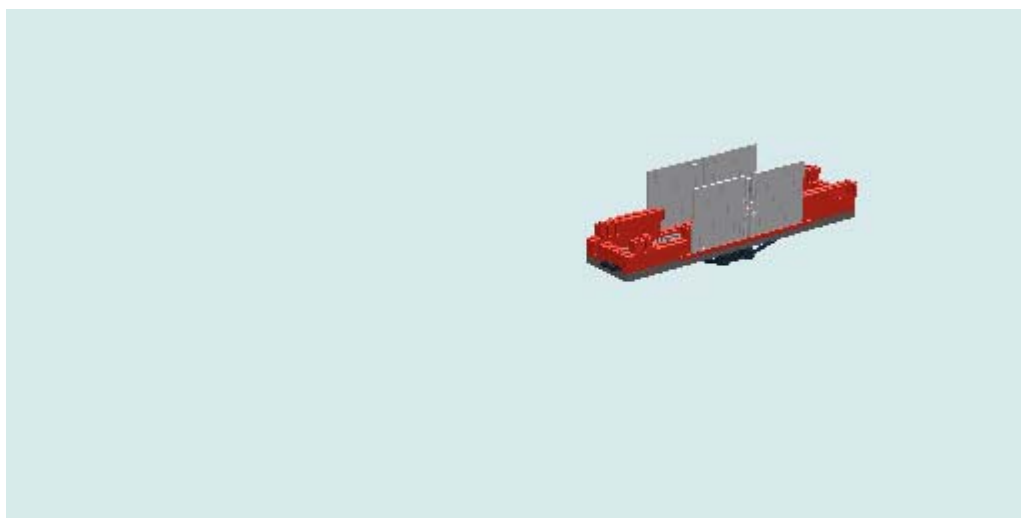

### Step 202

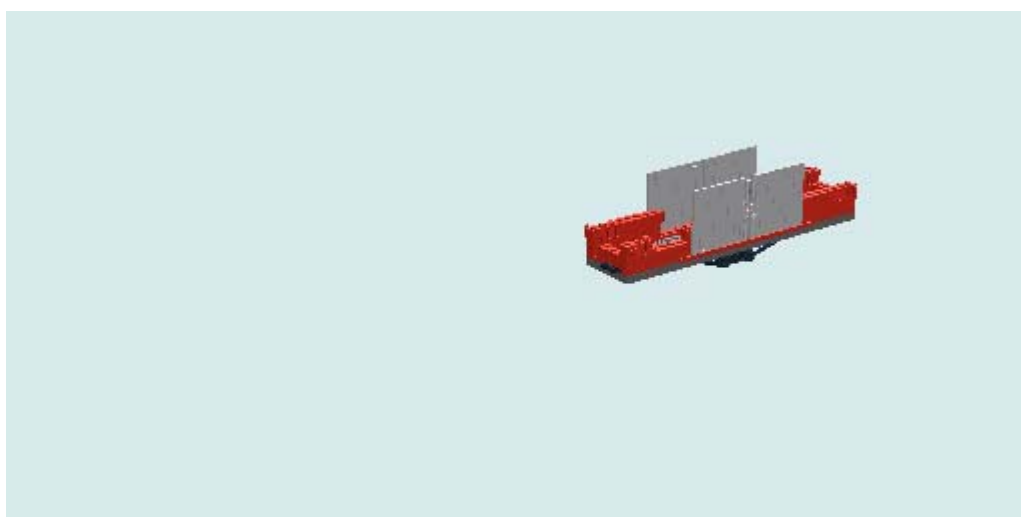

### Step 203



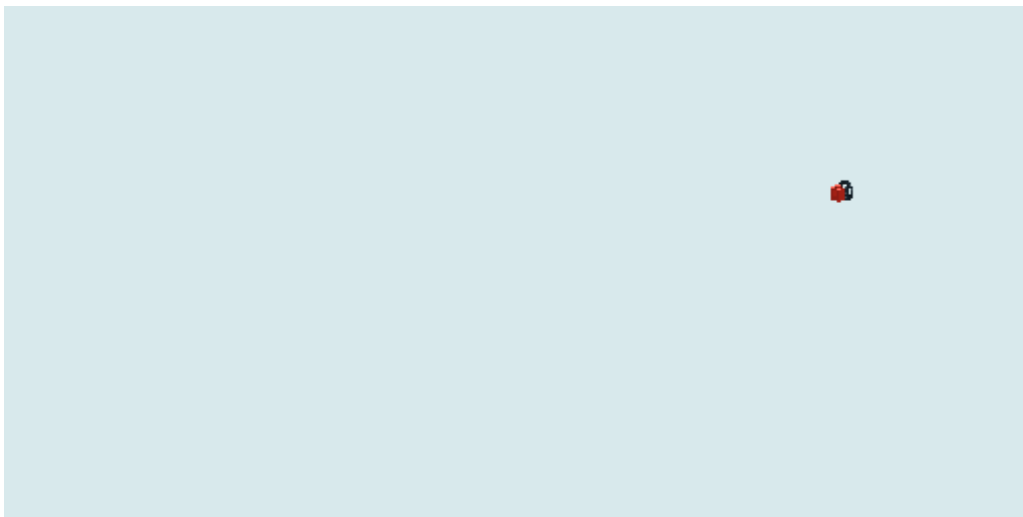

### Step 204

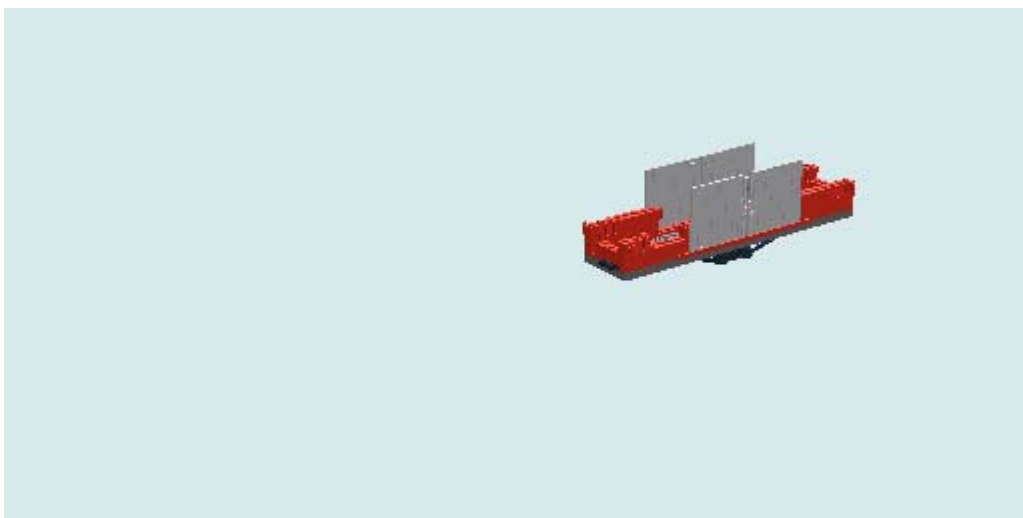

### Step 205

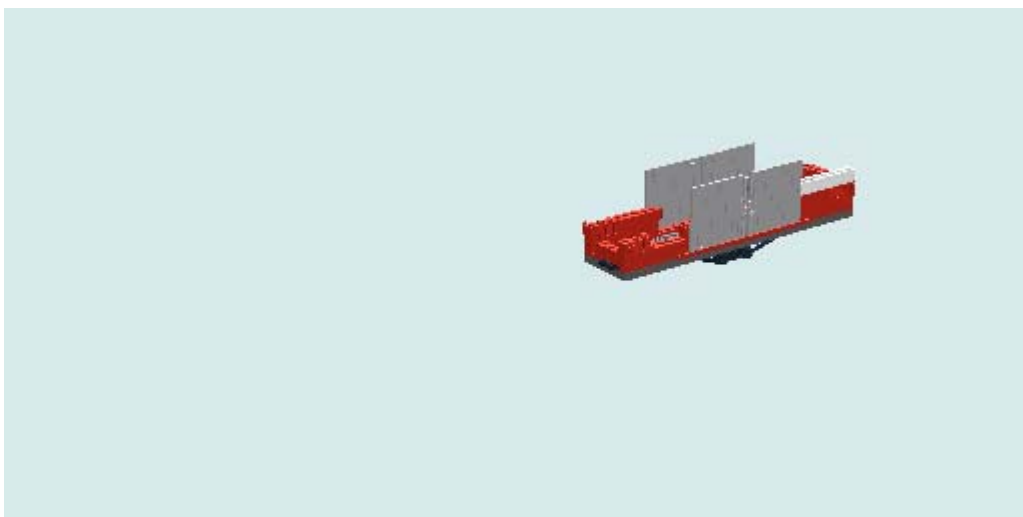
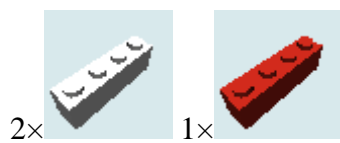

## Step 206

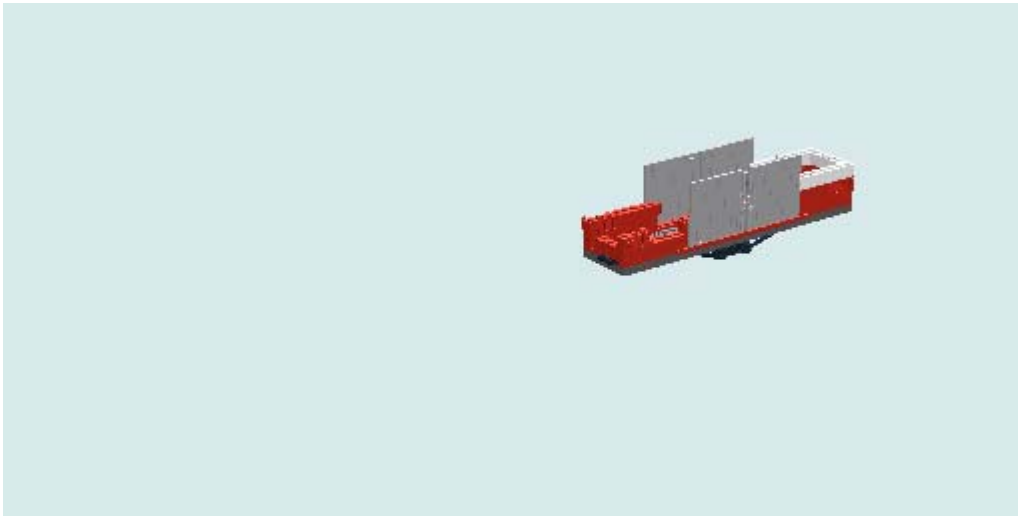
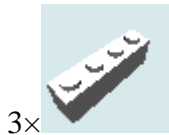

## Step 207



## Step 208



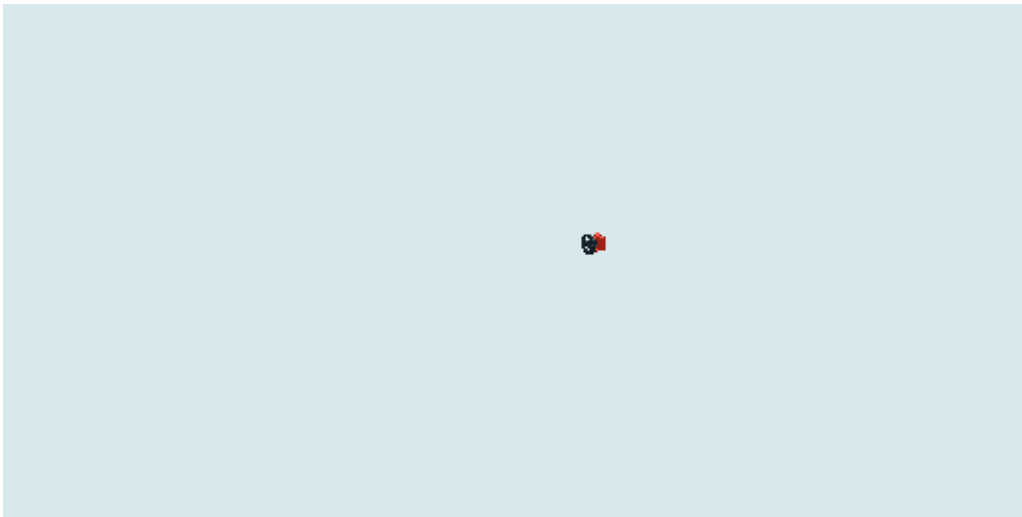

### Step 209



### Step 210

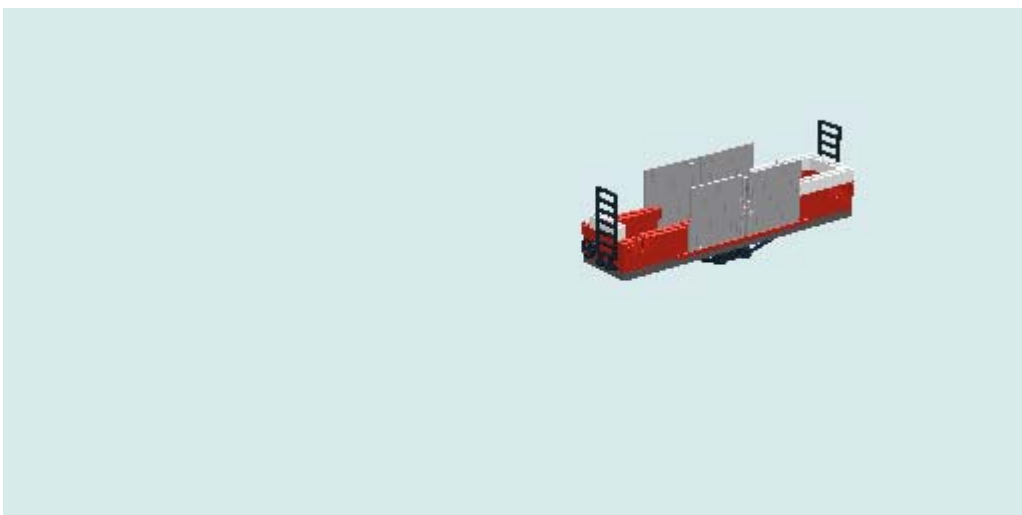
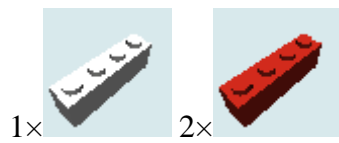

### Step 211

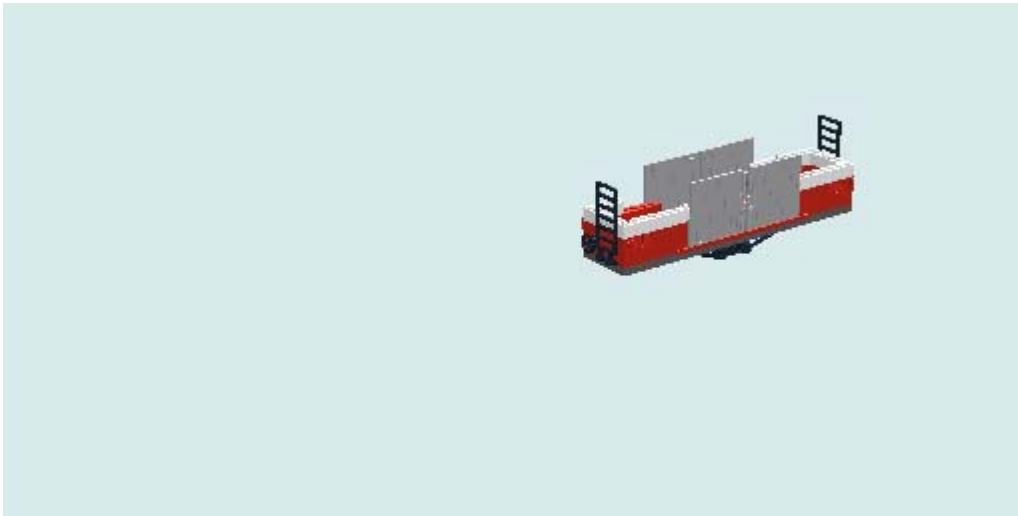
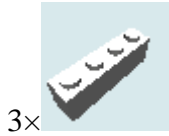

### Step 212

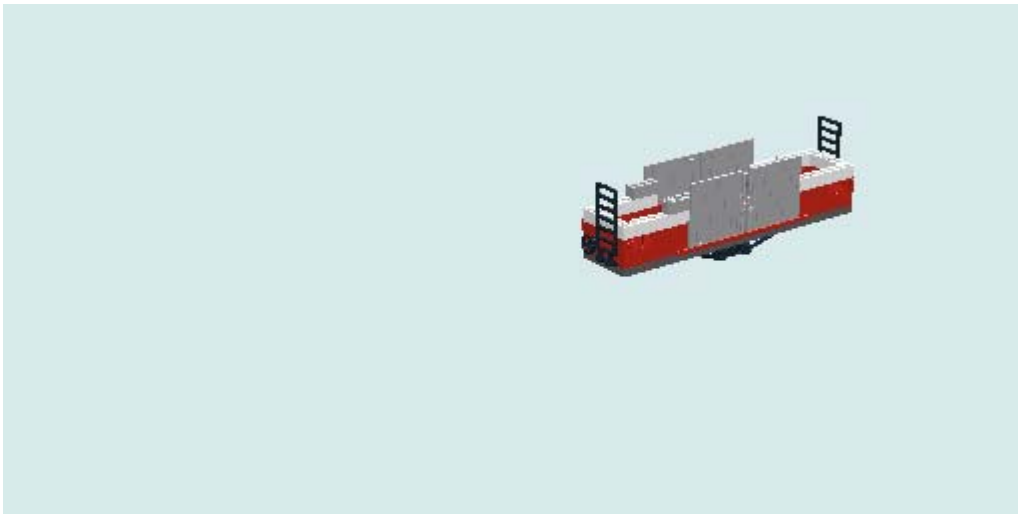
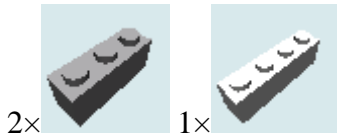

### Step 213

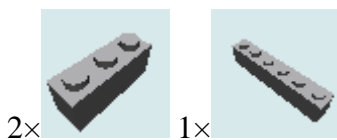



### Step 214

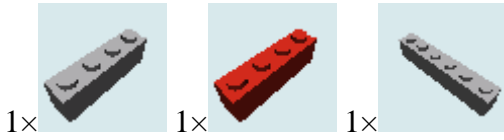

### Step 215

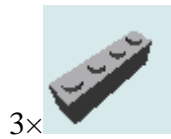



### Step 216

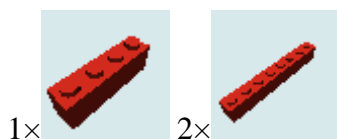

### Step 217

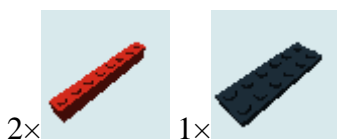



### Step 218

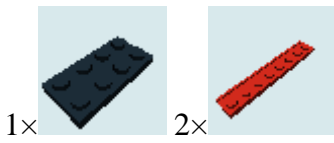

### Step 219

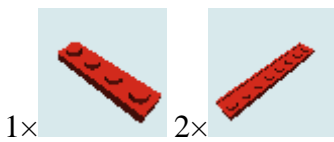



### Step 220

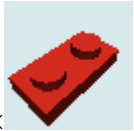

3x



### Step 221



3x



### Step 222

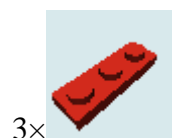

3x



### Step 223

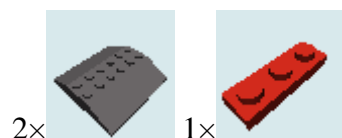

2x

1x



### Step 224

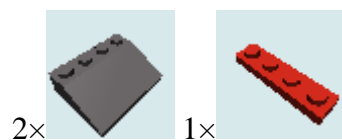

### Step 225

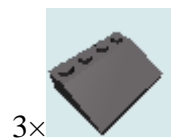



### Step 226



3x



### Step 227



3x



### Step 228



3x



### Step 229



1x



2x



### Step 230

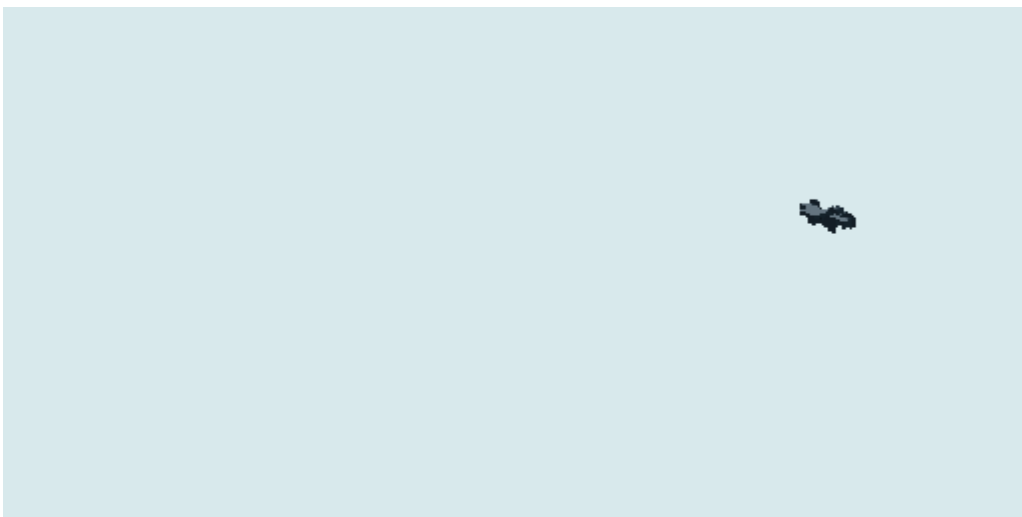

### Step 231



### Step 232



1x

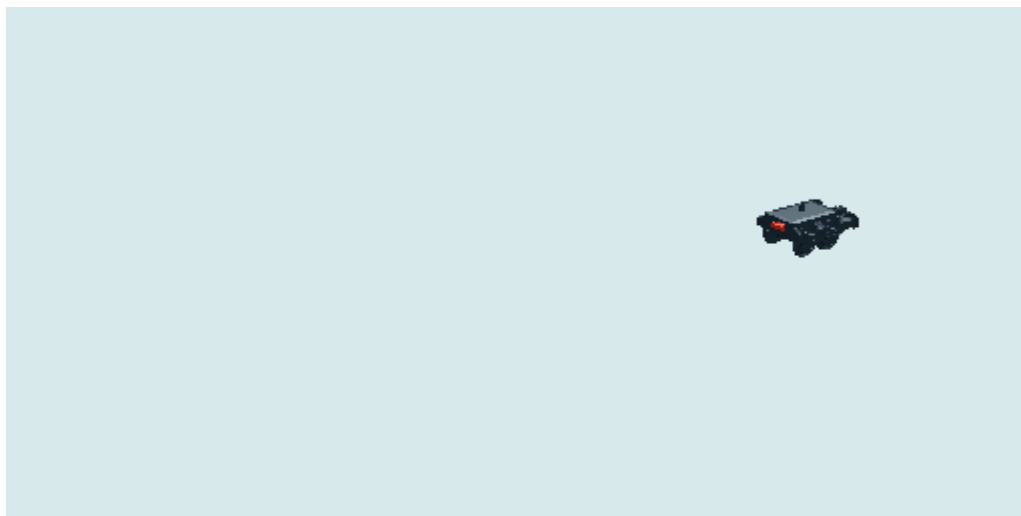

### Step 233



### Step 234



1x



2x

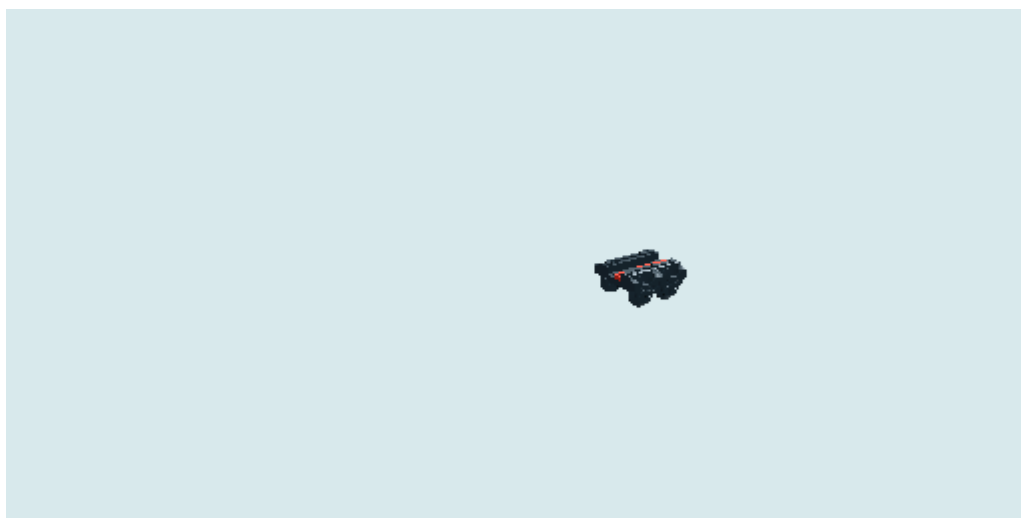

### Step 235



1x

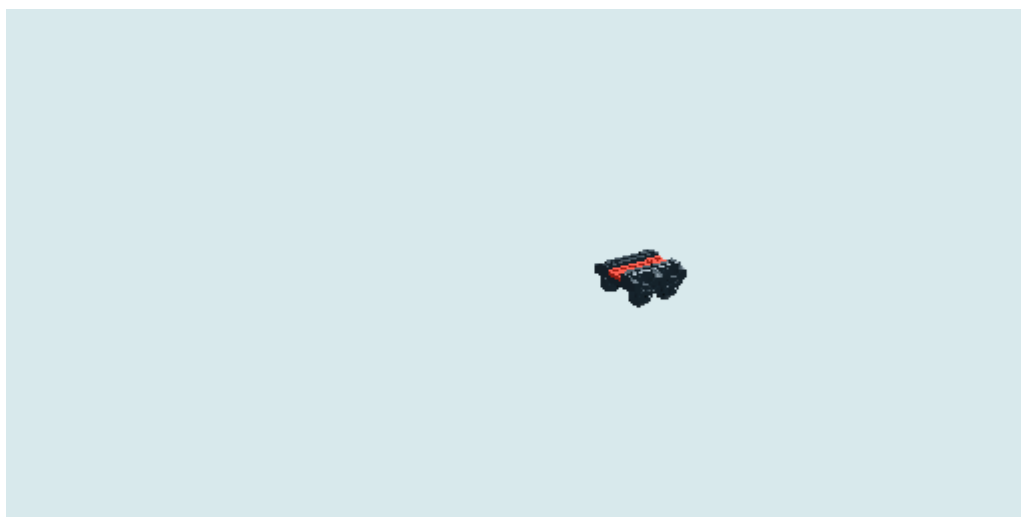

### Step 236



1x



1x



1x

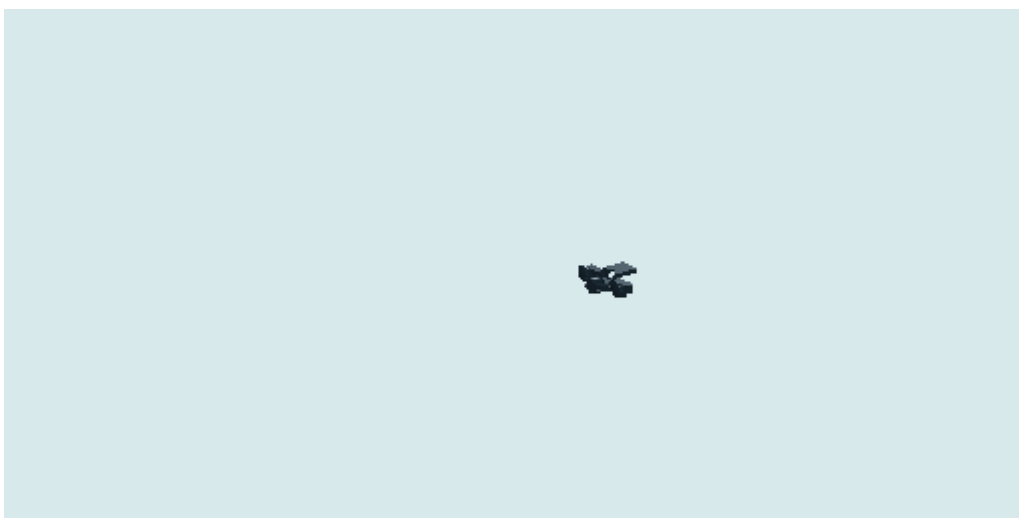

### Step 237

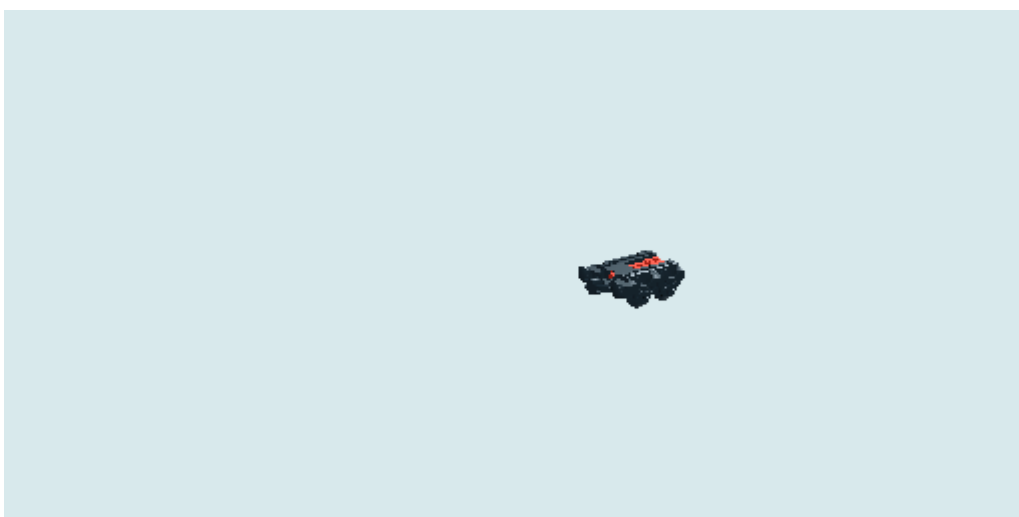

### Step 238

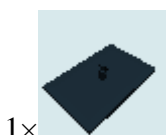

1x



## Step 239



## Step 240

