

LEGO

EXODUS



红蜘蛛

8115



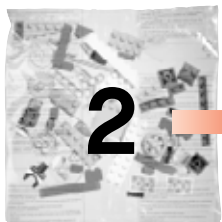

1

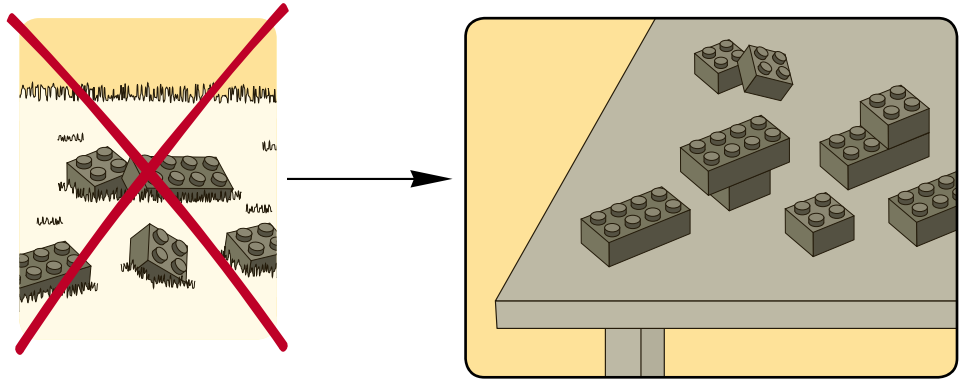

2

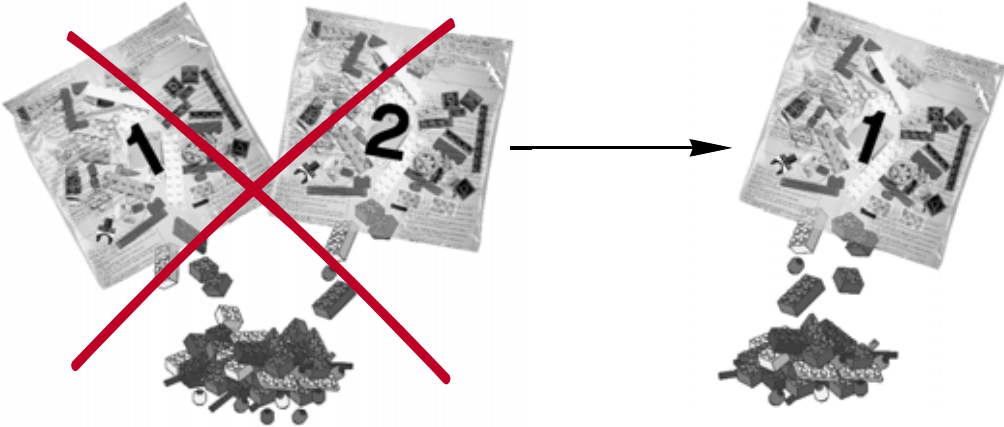



**1**

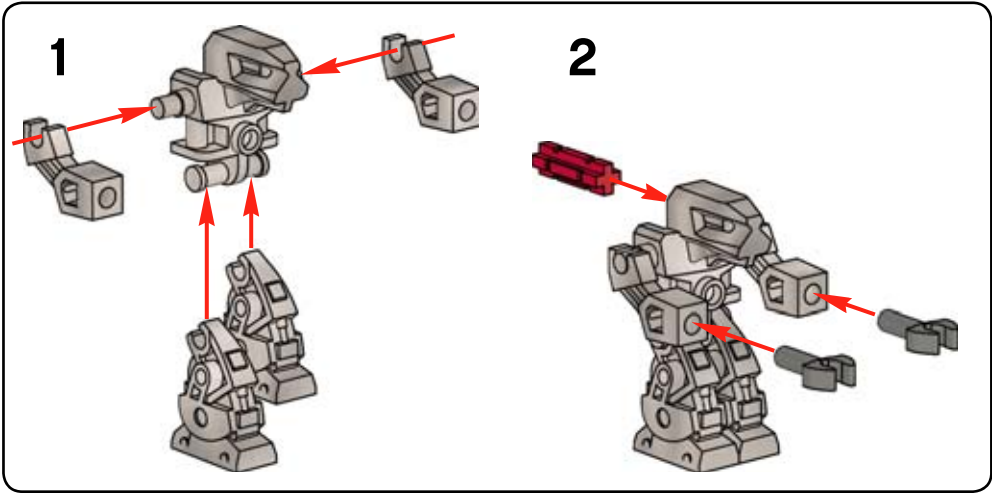

**3**



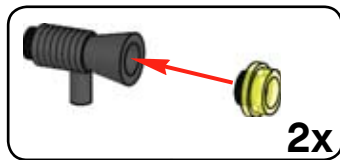

4





2x

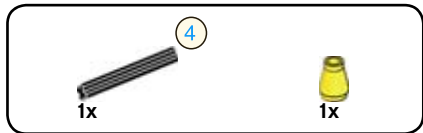

1

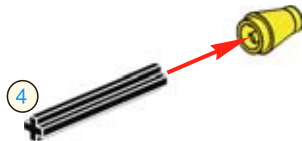

6

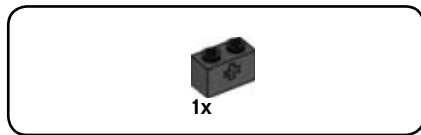

2





2x

3

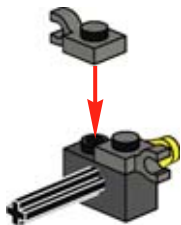

2x

4

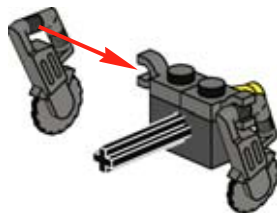



5



6

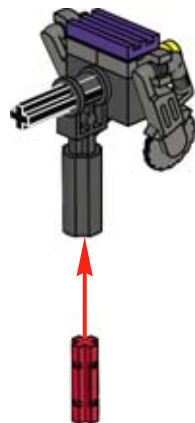

2x

5

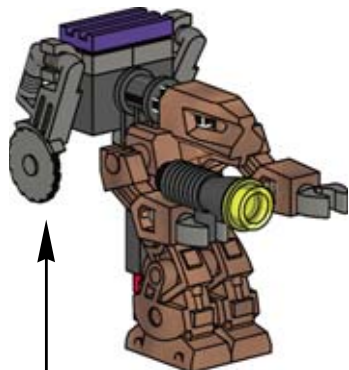



1x

1



2x

2

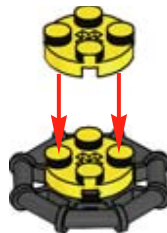

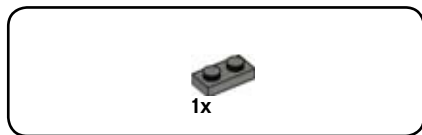

3

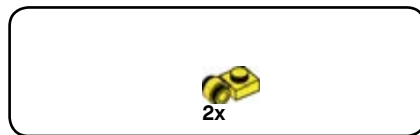

4

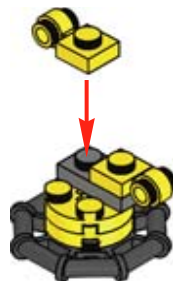



5



6

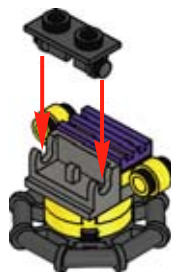



2x



2x

7



6x

8

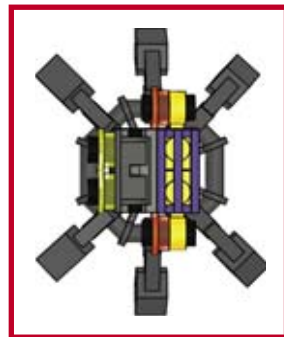



6x

9



1x



1x



1x



1x

10

1



2



3





1

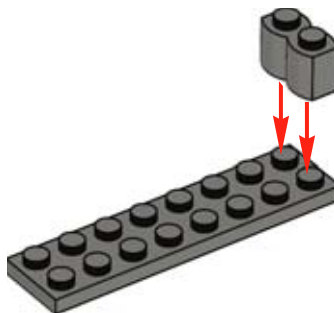



2

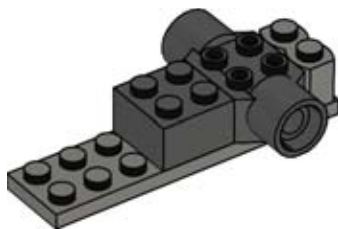

3





4

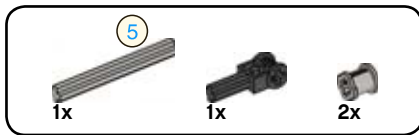
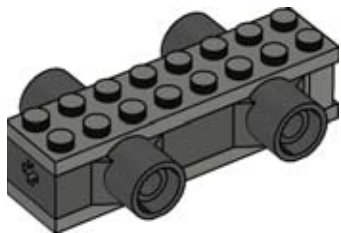

5

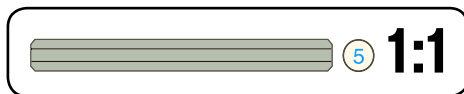
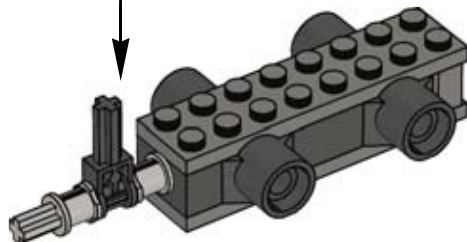
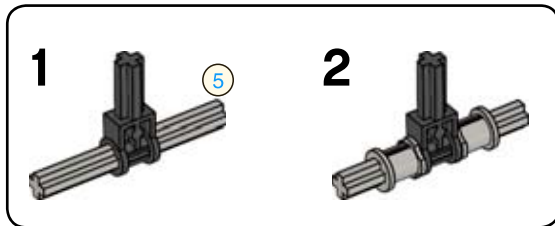



1



2





3

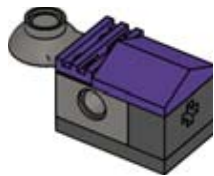

4

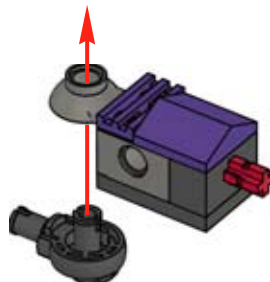

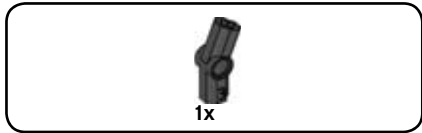

5

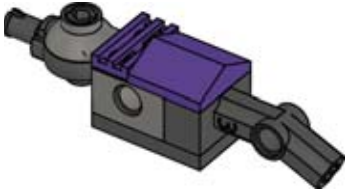

2x

6

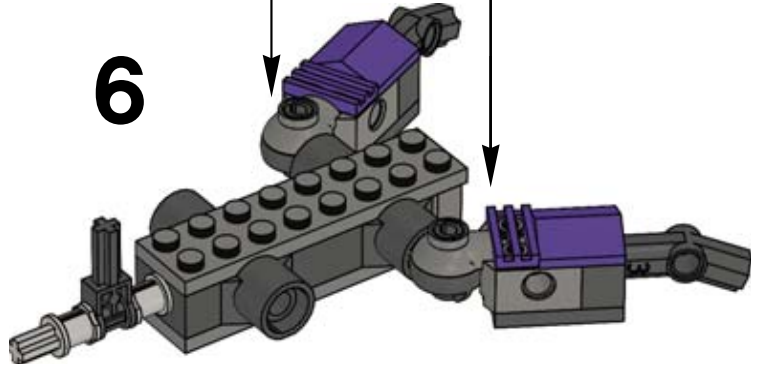



2x



1x

1



1x

1x

2





1x



1x

3

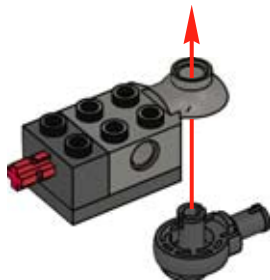

1x

4





5

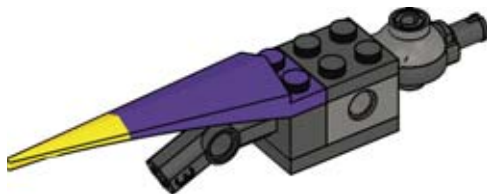

6

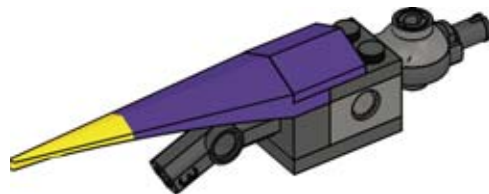

2x

7

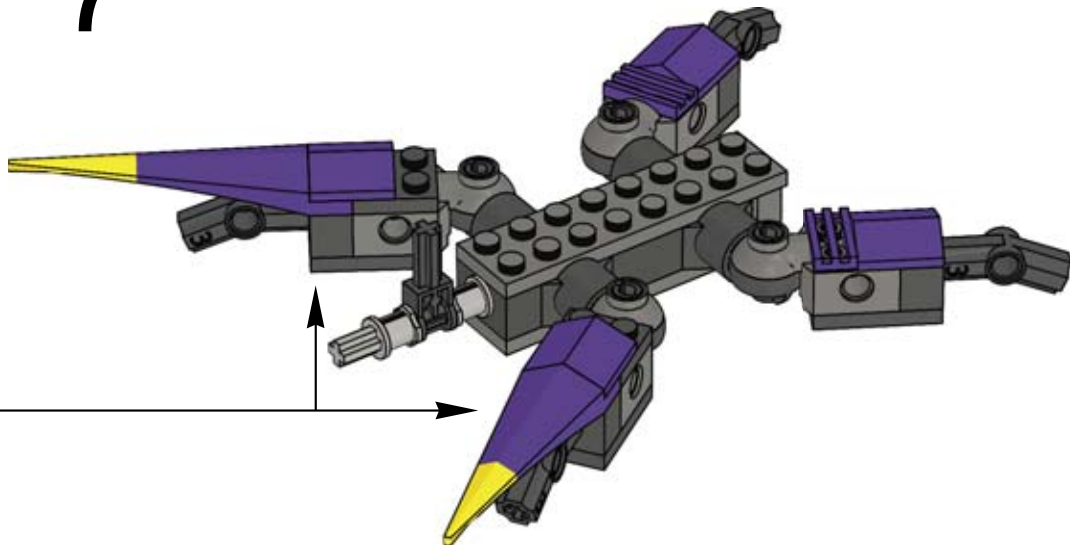



8

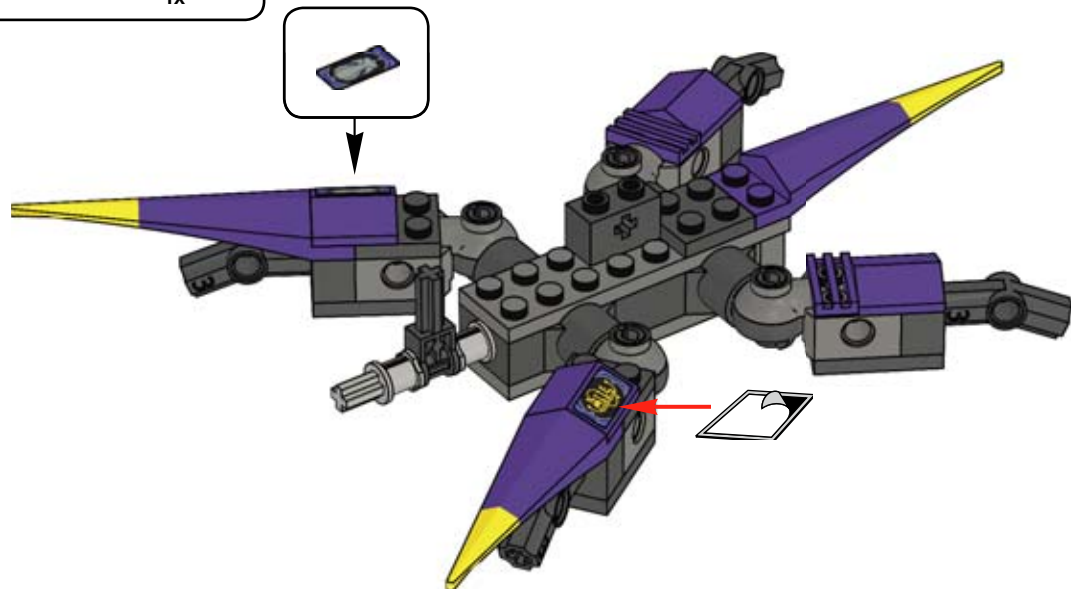

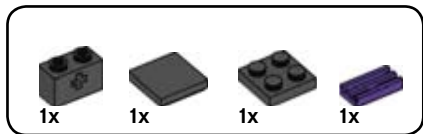

9

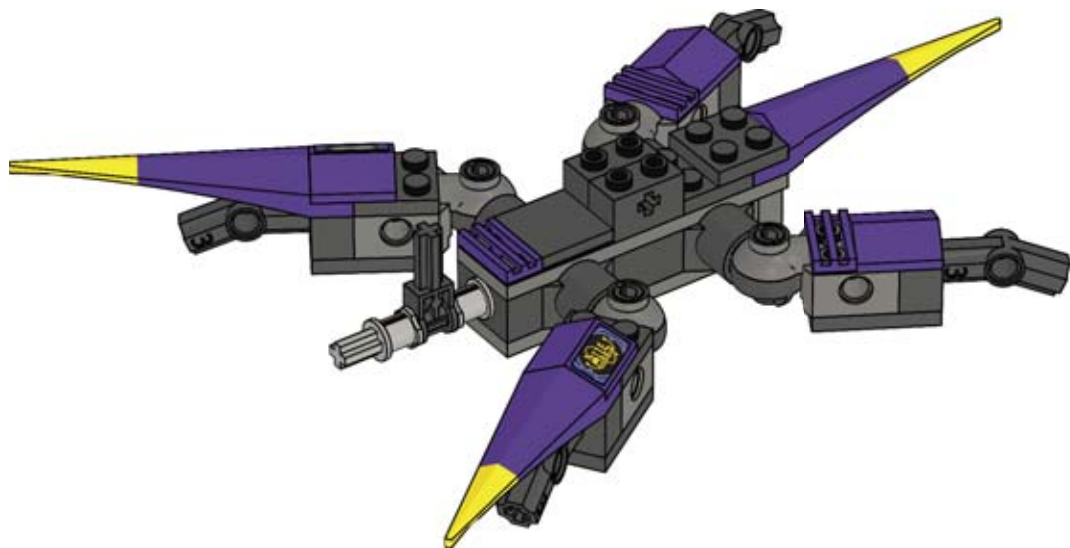



1x



1x

# 10

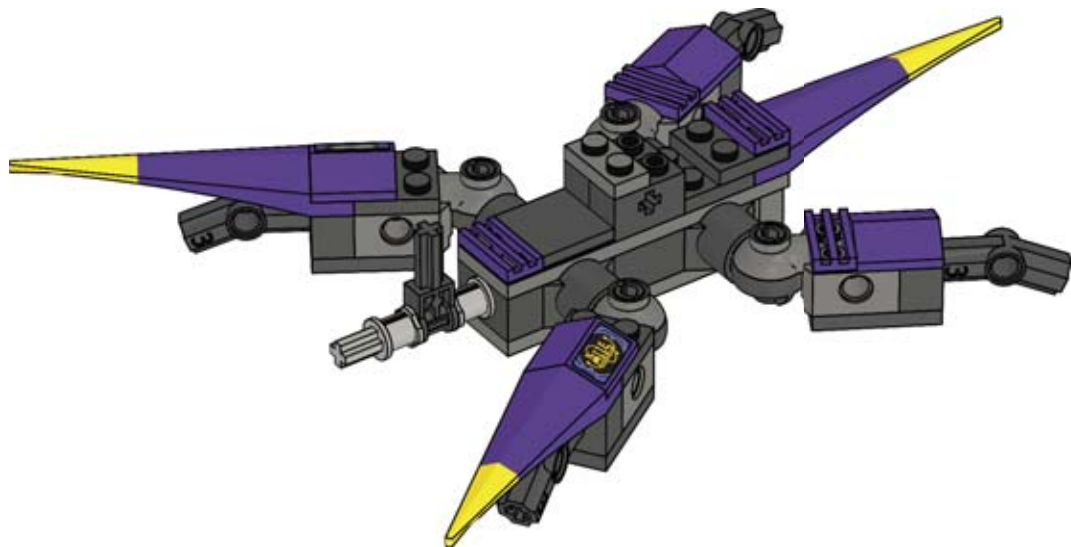



2x

11

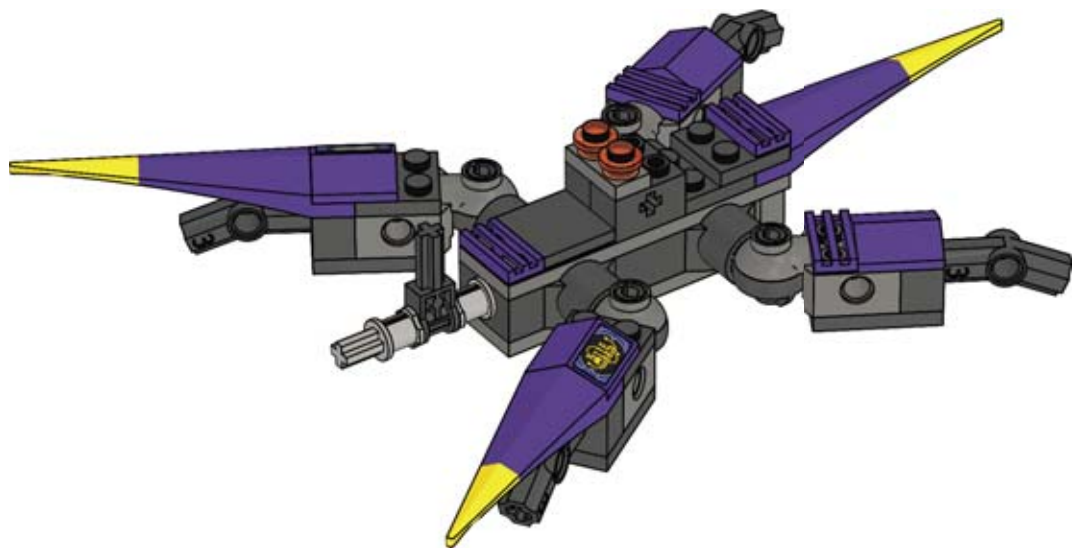



# 12

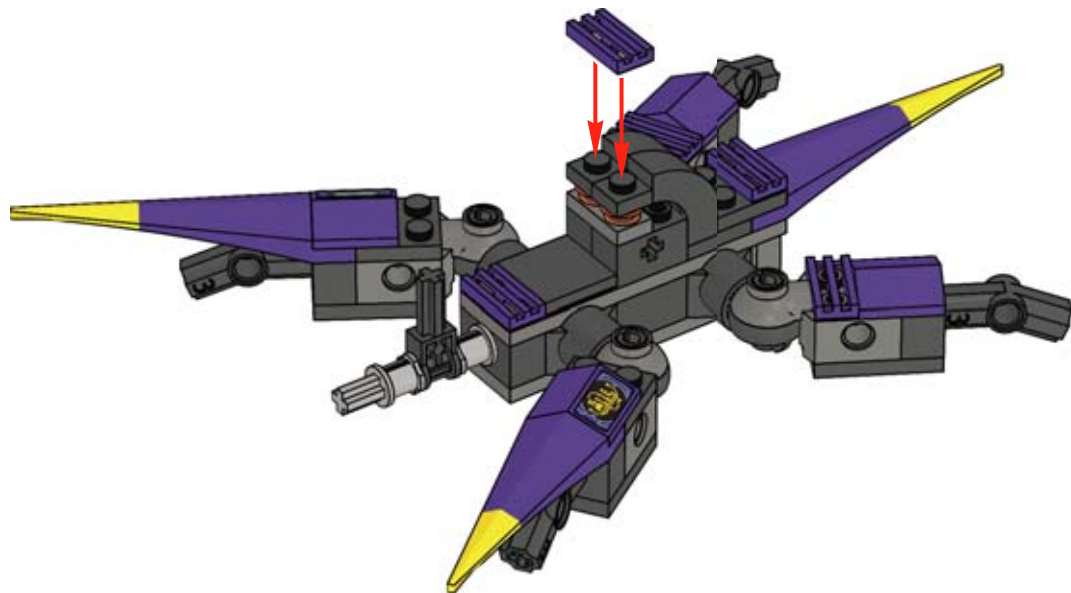

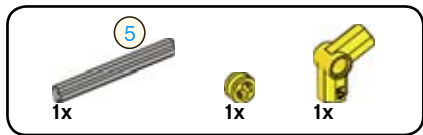

# 13

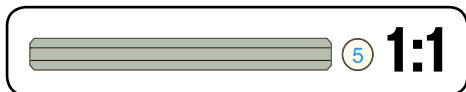
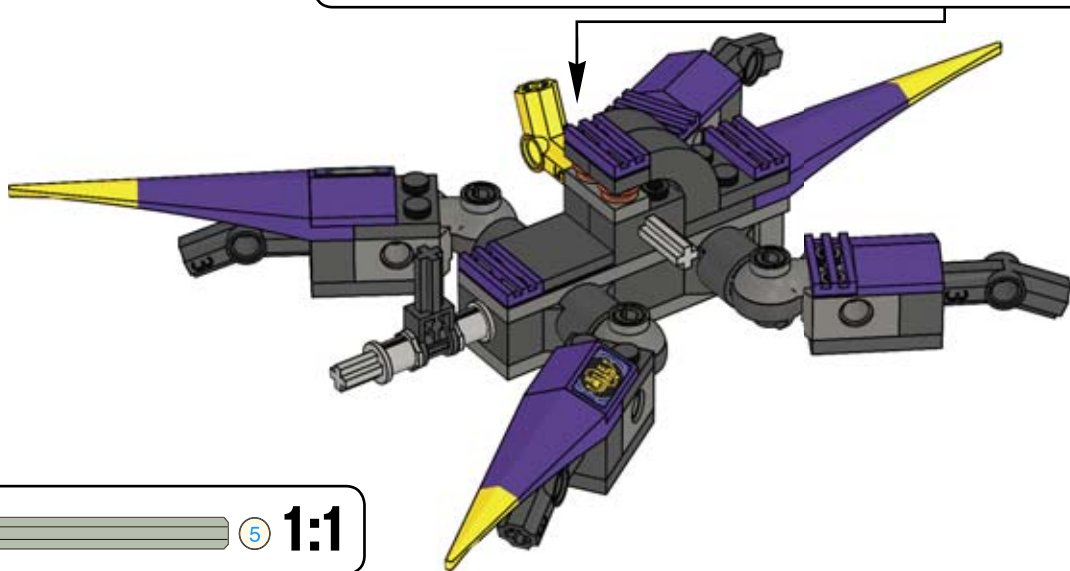
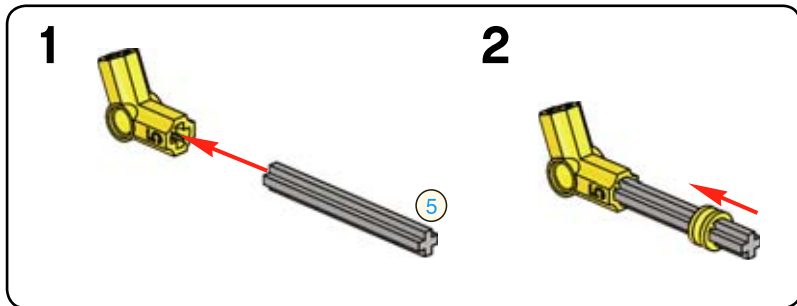



# 14

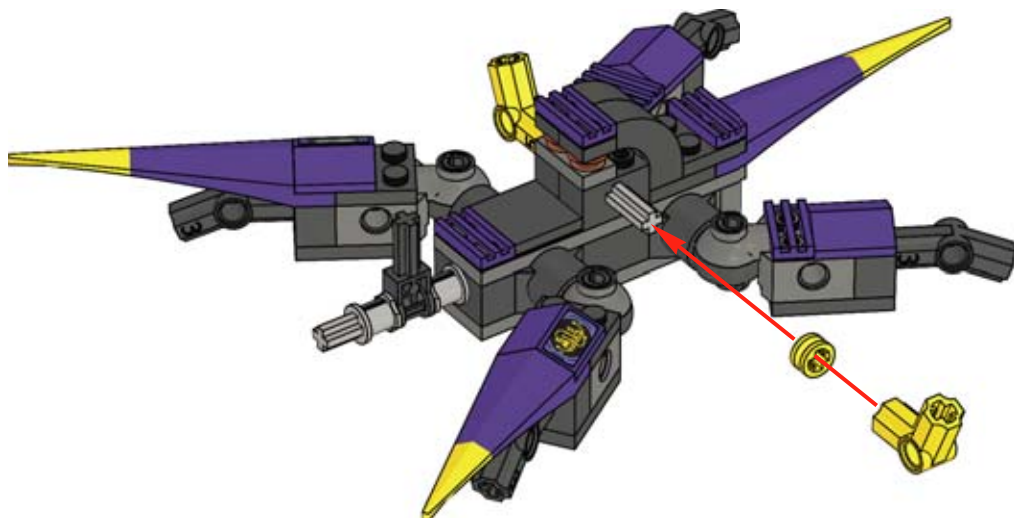

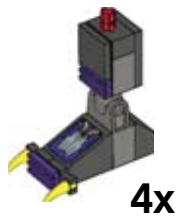

1

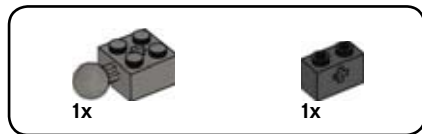

2



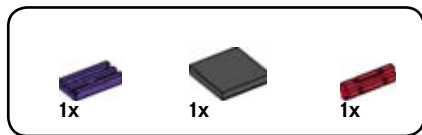

3

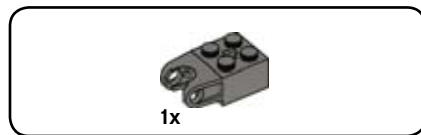
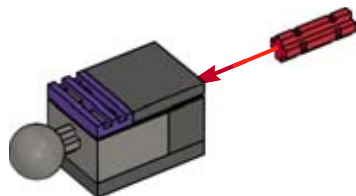

4

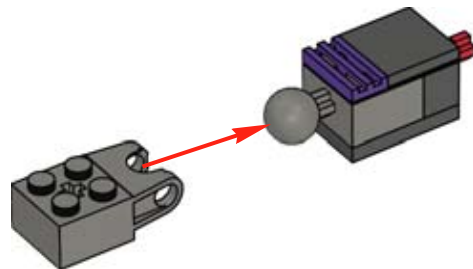



1x

5

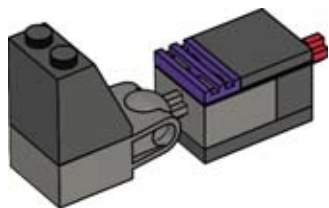

2x

6

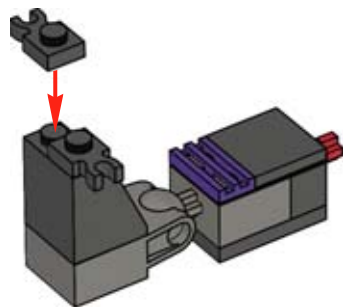



7

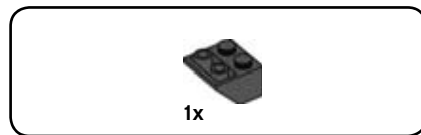
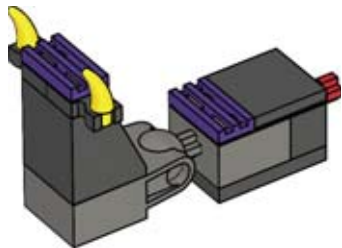

8

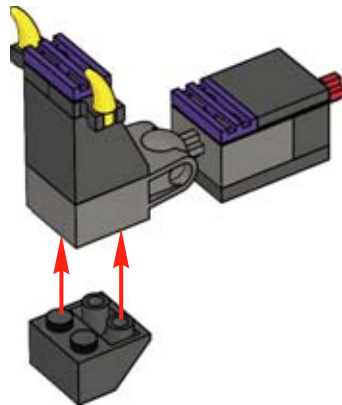

9

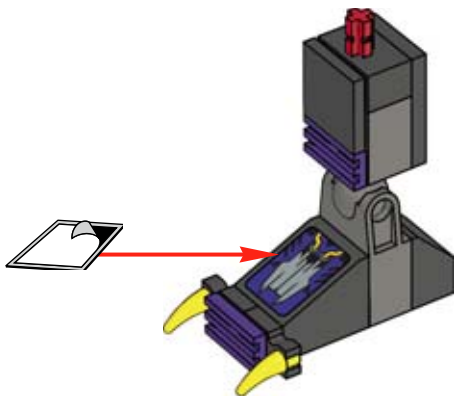

---

4x

15

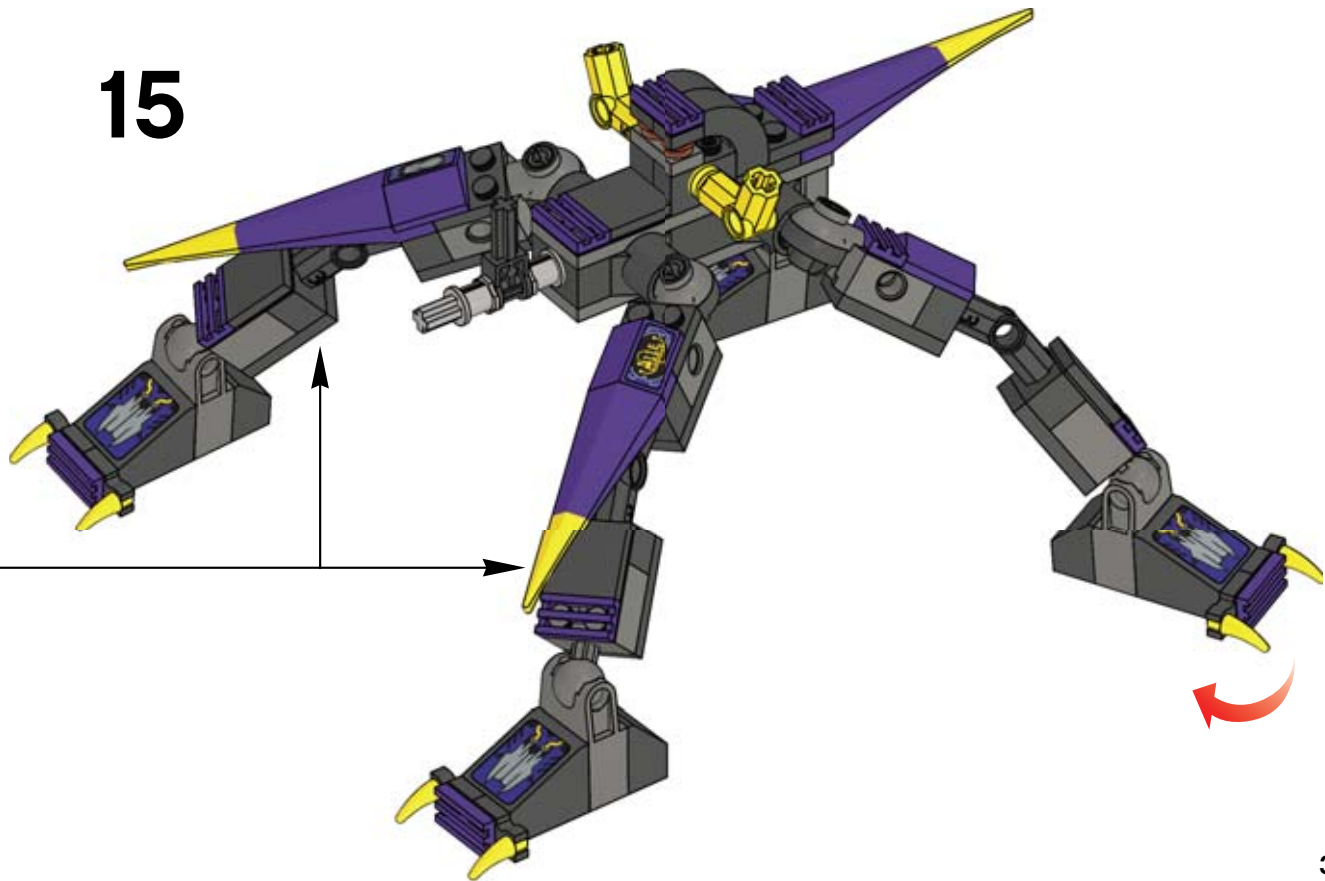



1x

1



2x

2





1x



2x

3

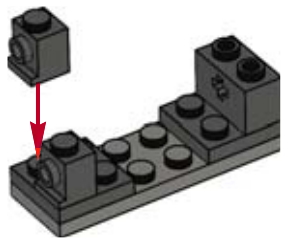

2x

4

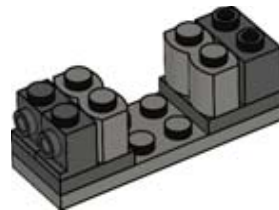



4x

5

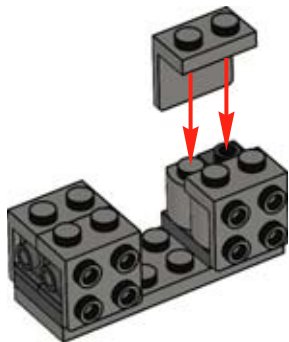

2x

6

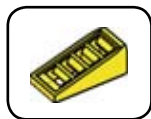



1x



2x

7

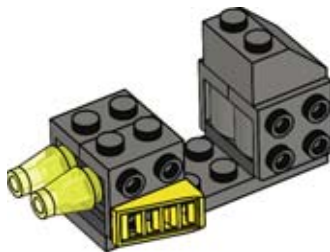

1x



1x

8

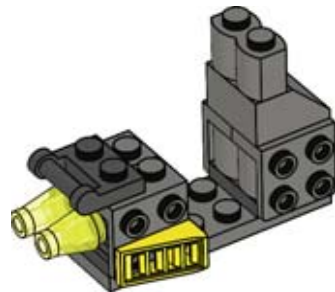

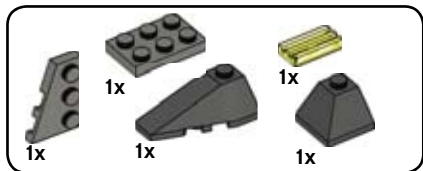

9

1

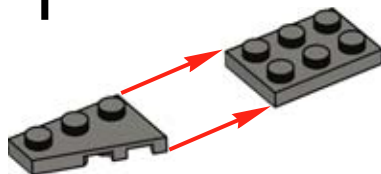

2

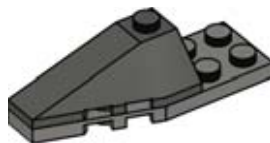

3



4

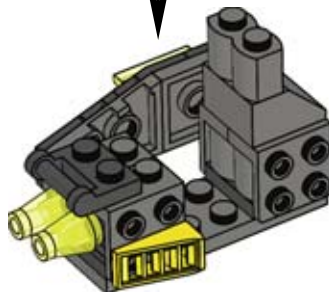
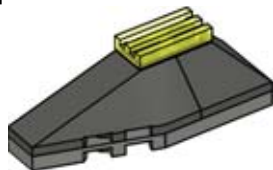

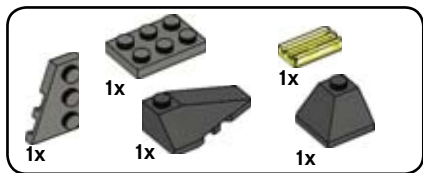

**10**

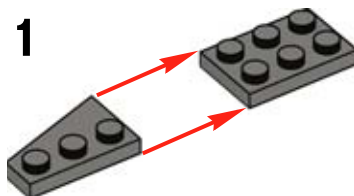

**2**

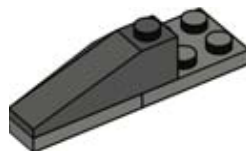

**3**

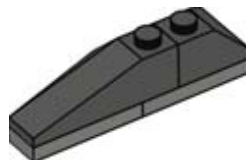

4

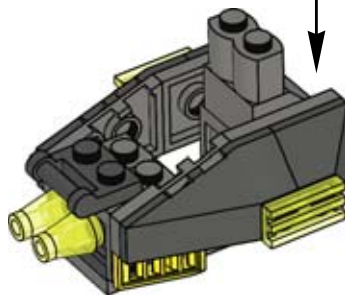
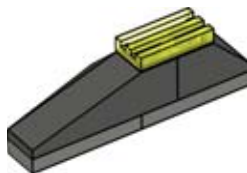

11





12

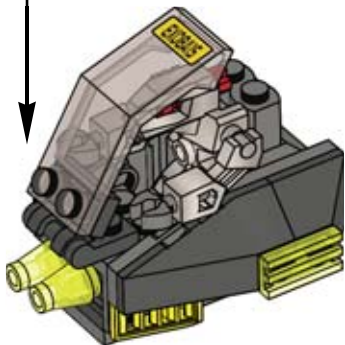
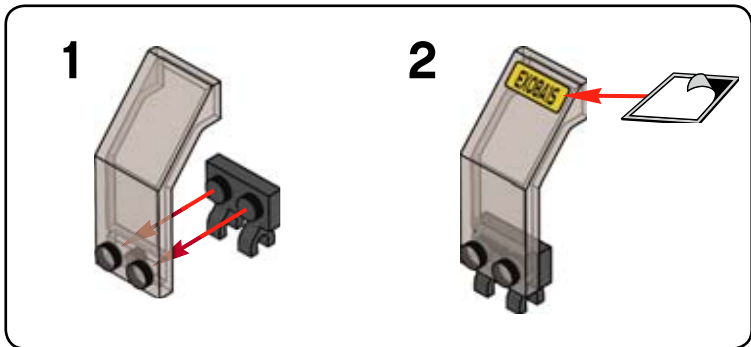

16

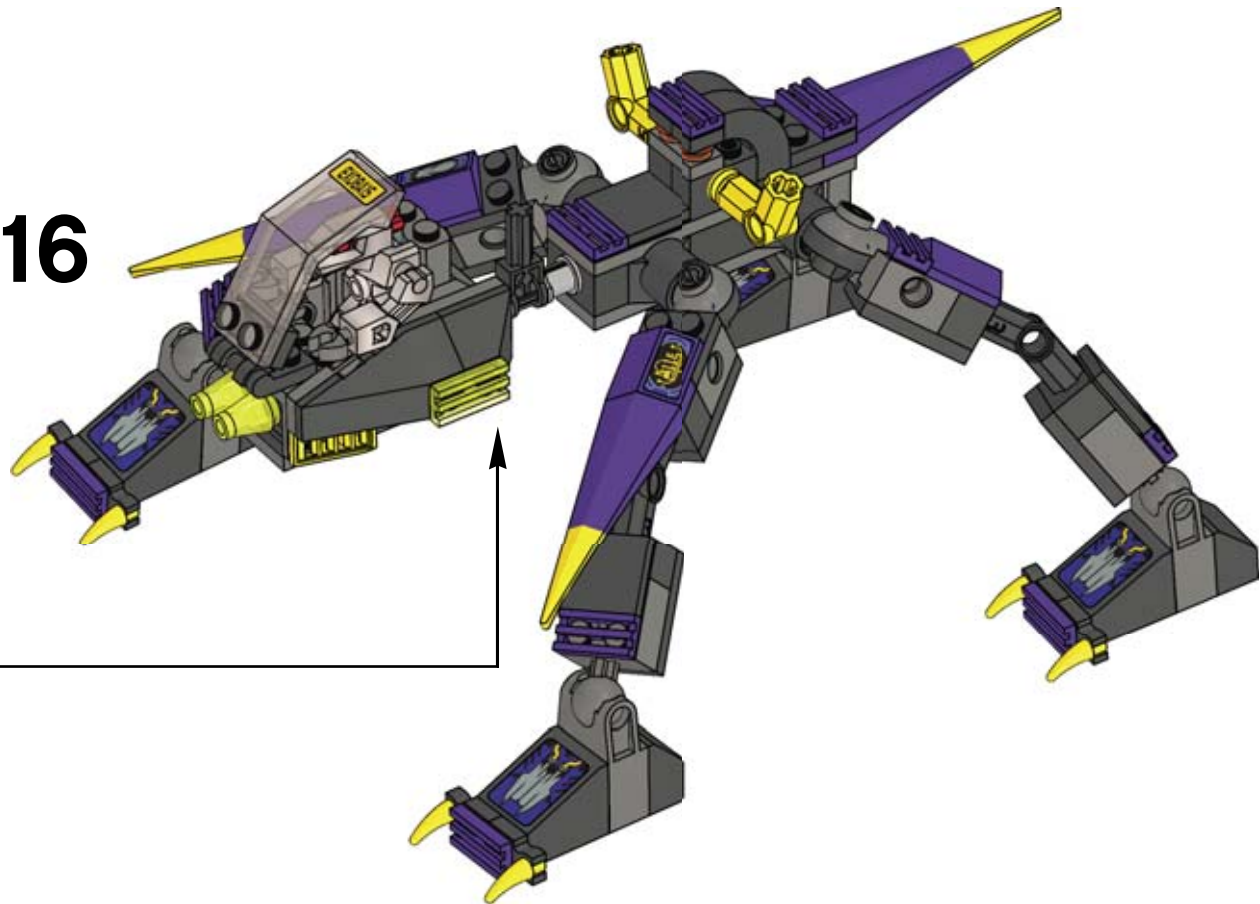



17

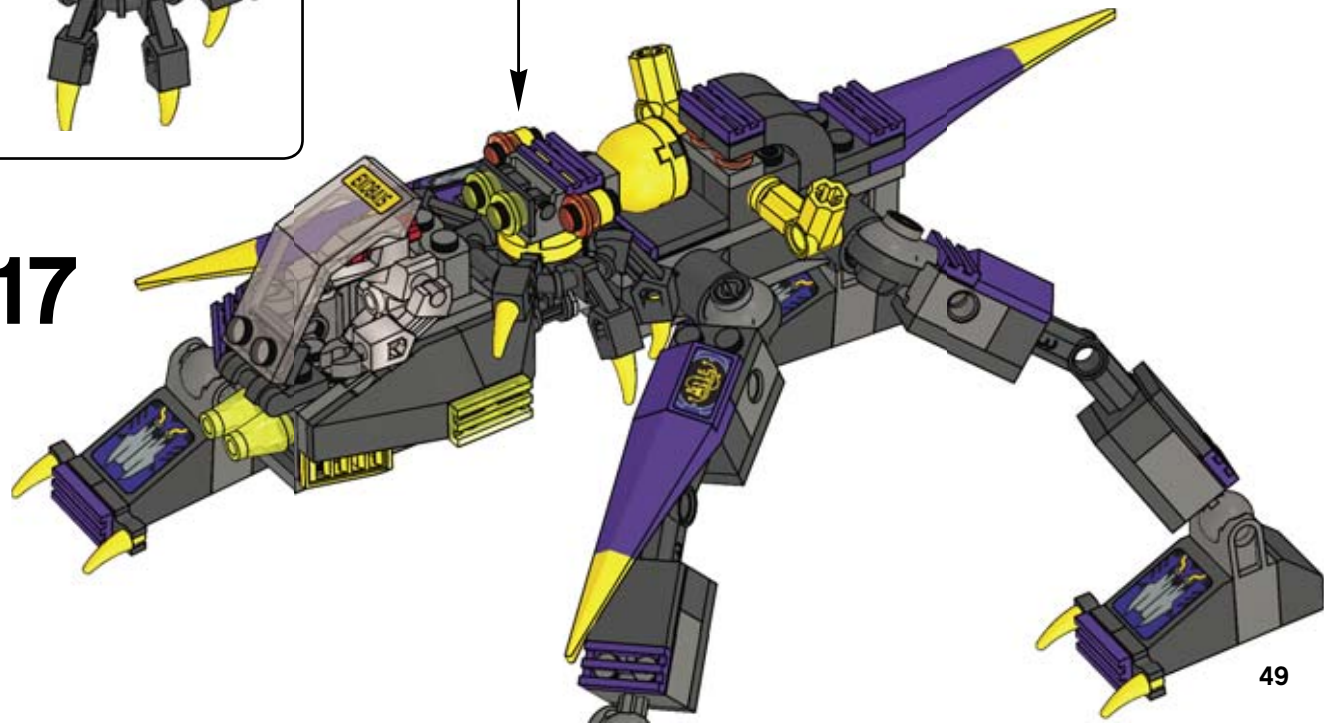



1

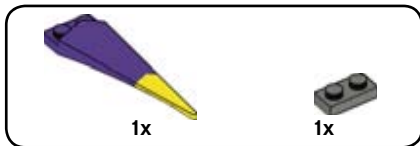

2

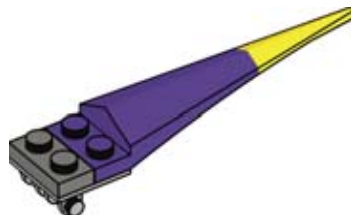



3

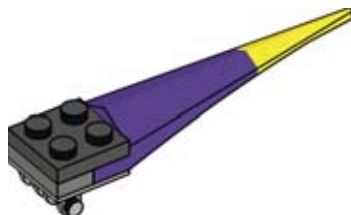

4

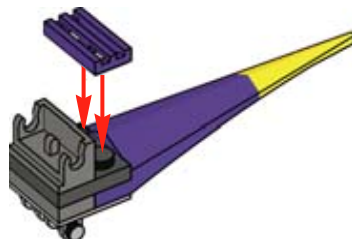



1x

5

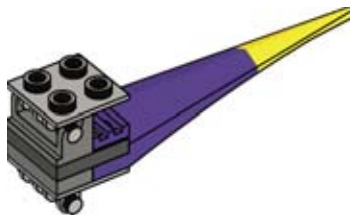

1x



1x

6

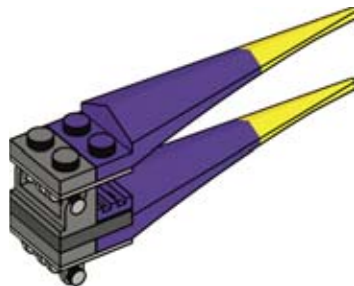



1x

7

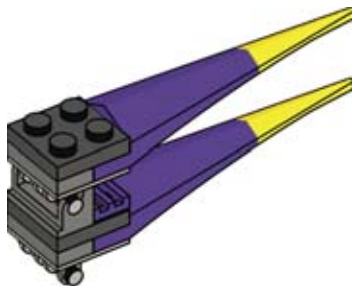

1x



1x

8

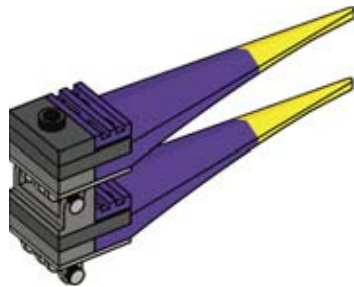



9

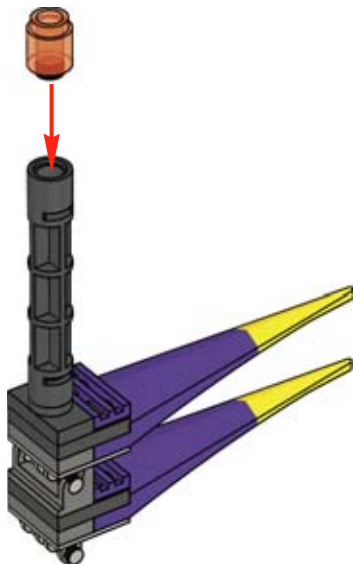

10

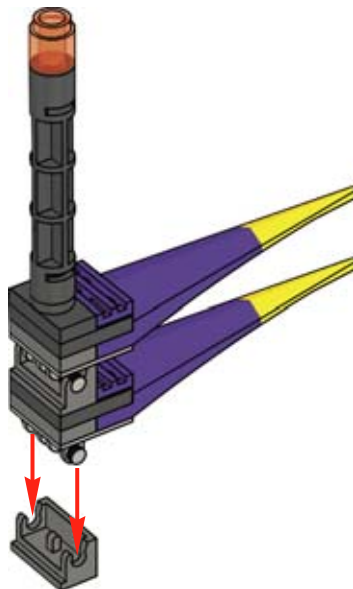

18

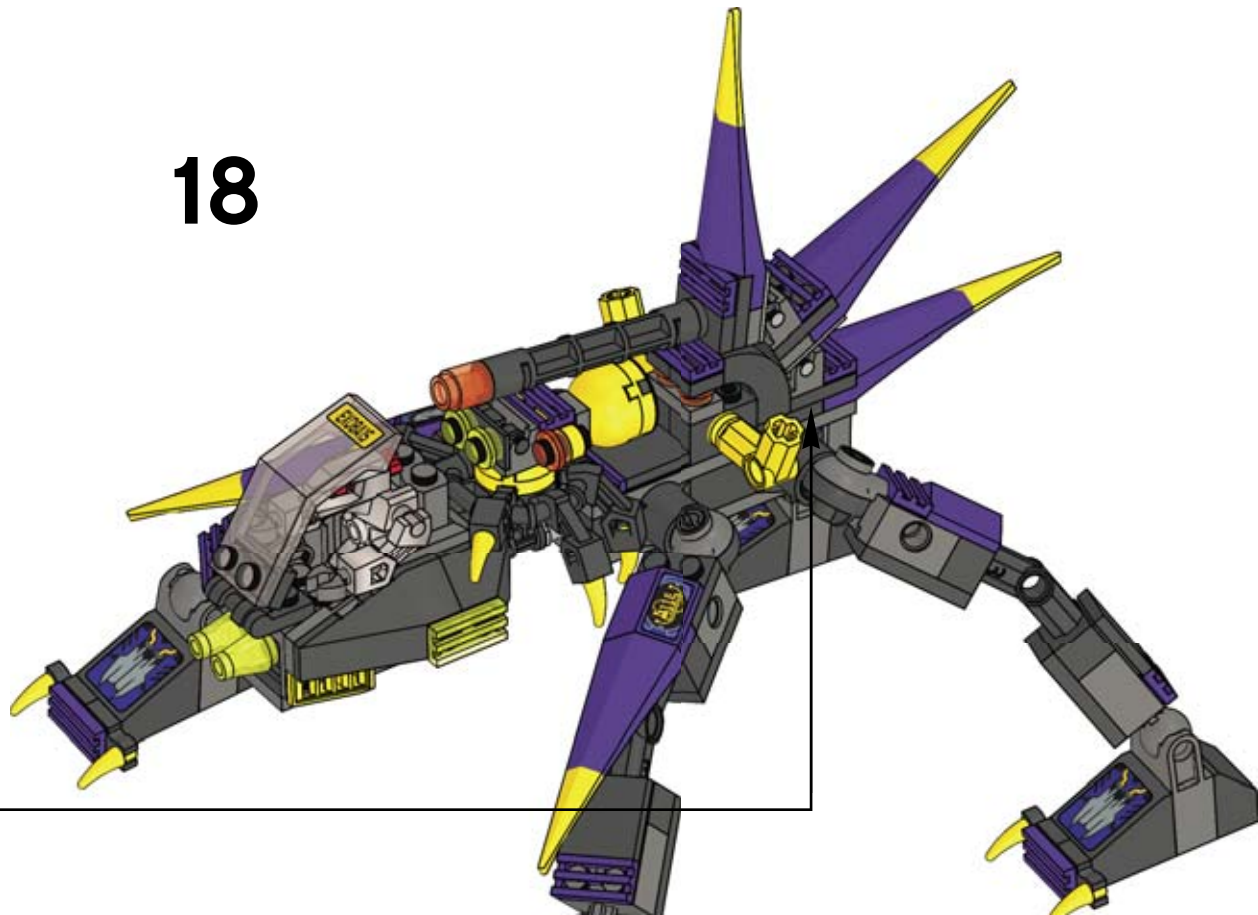





1x  
4204624



4x  
4291056



5x  
4521900



4x  
4291054



2x  
4291057



11x  
4142865



1x  
4153989



4x  
3005747



2x  
4239601



2x  
4521998



1x  
4216656



14x  
4521048



2x  
408124



2x  
458924



3x  
403224



2x  
4521167



4x  
4107082



2x  
407026



6x  
4294996



14x  
4233487



1x  
300326



2x  
4275826



2x  
4188168



3x  
4107765

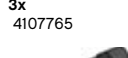

1x  
4155558



2x  
4189064



2x  
370526



2x  
4512363



5x  
306826



4x  
4213374



2x  
434926



1x  
4514342



8x  
408526



1x  
393826



1x  
379426

4



1x  
4225201



1x  
4519849



8x  
302226



8x  
302126



4x  
366026



4x  
4273703



1x  
4180413



1x  
4180423



1x  
4278359



2x  
618849



2x  
4272661



4x  
3005749



2x  
4211622



2x  
4211639



2x  
4211881



4x  
4277928



4x  
4497253



4x  
4524353

5



4x  
4227395



4x  
4211080



4x  
4211095



5x  
4216973



4x  
4211063



2x  
4211043



1x  
4210872



1x  
4210869



3x  
4211066



2x  
4210997



1x  
4211002



1x  
4211054



6x  
4289542



18x  
4297453



4x  
4521168



2x  
4494595



2x  
4494600



1x  
4494597