

BIONICLE®

WWW.BIONICLE.COM



AXON

8733



Achtung: Nicht geeignet für ein Baby und Kleinkinder bis zum Alter von 3 Jahren. Ein Kind oder Kleinkind, wenn es nicht beaufsichtigt wird, kann ein Teil des Bausteins in den Mund stecken, was zu Erstickungsgefahr führt.

Warning: Not suitable for a baby and children under 3 years of age. A child or toddler, if not supervised, may put a part of the building set into his or her mouth, which may lead to choking.

Attenzione: Non adatto per un bambino o un piccolo fino a 3 anni di età. Un bambino o un piccolo, se non è supervisionato, potrebbe mettere una parte del set di costruzione nella bocca, il che potrebbe causare soffocamento.

Advertencia: No apto para bebés o niños menores de 3 años. Un niño o una niña, si no está supervisado, podría meter una parte del set de construcción en la boca, lo que podría causar asfixia.

1

60000 The LEGO Group

Beachte: Nicht geeignet für ein Baby und Kleinkinder bis zum Alter von 3 Jahren. Ein Kind oder Kleinkind, wenn es nicht beaufsichtigt wird, kann ein Teil des Bausteins in den Mund stecken, was zu Erstickungsgefahr führt.

Warning: Not suitable for a baby and children under 3 years of age. A child or toddler, if not supervised, may put a part of the building set into his or her mouth, which may lead to choking.

Attenzione: Non adatto per un bambino o un piccolo fino a 3 anni di età. Un bambino o un piccolo, se non è supervisionato, potrebbe mettere una parte del set di costruzione nella bocca, il che potrebbe causare soffocamento.

Advertencia: No apto para bebés o niños menores de 3 años. Un niño o una niña, si no está supervisado, podría meter una parte del set de construcción en la boca, lo que podría causar asfixia.



Achtung: Nicht geeignet für ein Baby und Kleinkinder bis zum Alter von 3 Jahren. Ein Kind oder Kleinkind, wenn es nicht beaufsichtigt wird, kann ein Teil des Bausteins in den Mund stecken, was zu Erstickungsgefahr führt.

Warning: Not suitable for a baby and children under 3 years of age. A child or toddler, if not supervised, may put a part of the building set into his or her mouth, which may lead to choking.

Attenzione: Non adatto per un bambino o un piccolo fino a 3 anni di età. Un bambino o un piccolo, se non è supervisionato, potrebbe mettere una parte del set di costruzione nella bocca, il che potrebbe causare soffocamento.

Advertencia: No apto para bebés o niños menores de 3 años. Un niño o una niña, si no está supervisado, podría meter una parte del set de construcción en la boca, lo que podría causar asfixia.

1

60000 The LEGO Group

Beachte: Nicht geeignet für ein Baby und Kleinkinder bis zum Alter von 3 Jahren. Ein Kind oder Kleinkind, wenn es nicht beaufsichtigt wird, kann ein Teil des Bausteins in den Mund stecken, was zu Erstickungsgefahr führt.

Warning: Not suitable for a baby and children under 3 years of age. A child or toddler, if not supervised, may put a part of the building set into his or her mouth, which may lead to choking.

Attenzione: Non adatto per un bambino o un piccolo fino a 3 anni di età. Un bambino o un piccolo, se non è supervisionato, potrebbe mettere una parte del set di costruzione nella bocca, il che potrebbe causare soffocamento.

Advertencia: No apto para bebés o niños menores de 3 años. Un niño o una niña, si no está supervisado, podría meter una parte del set de construcción en la boca, lo que podría causar asfixia.

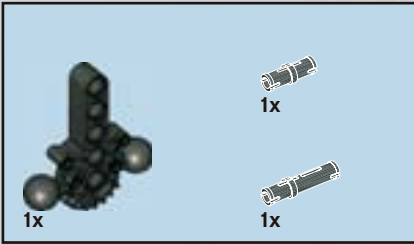

1

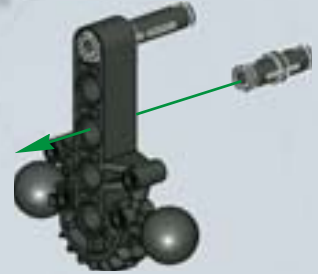
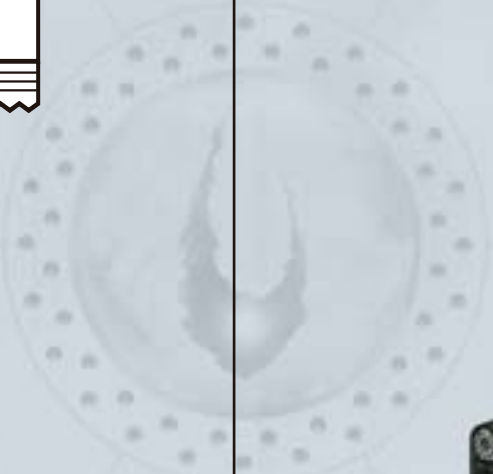



2



3

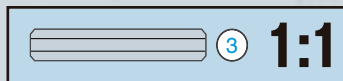
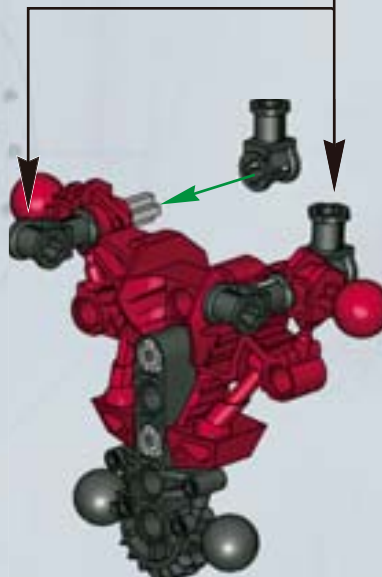

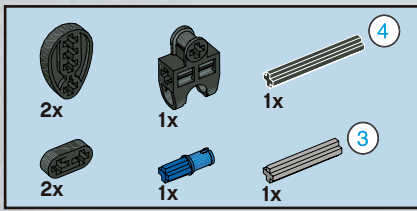

4

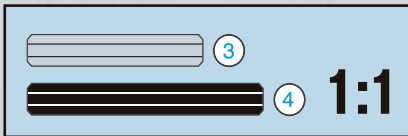
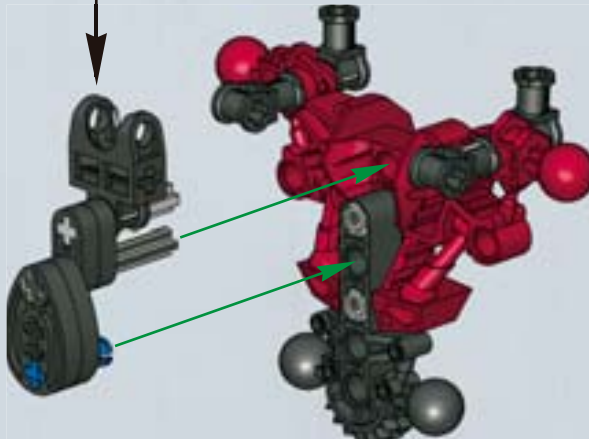
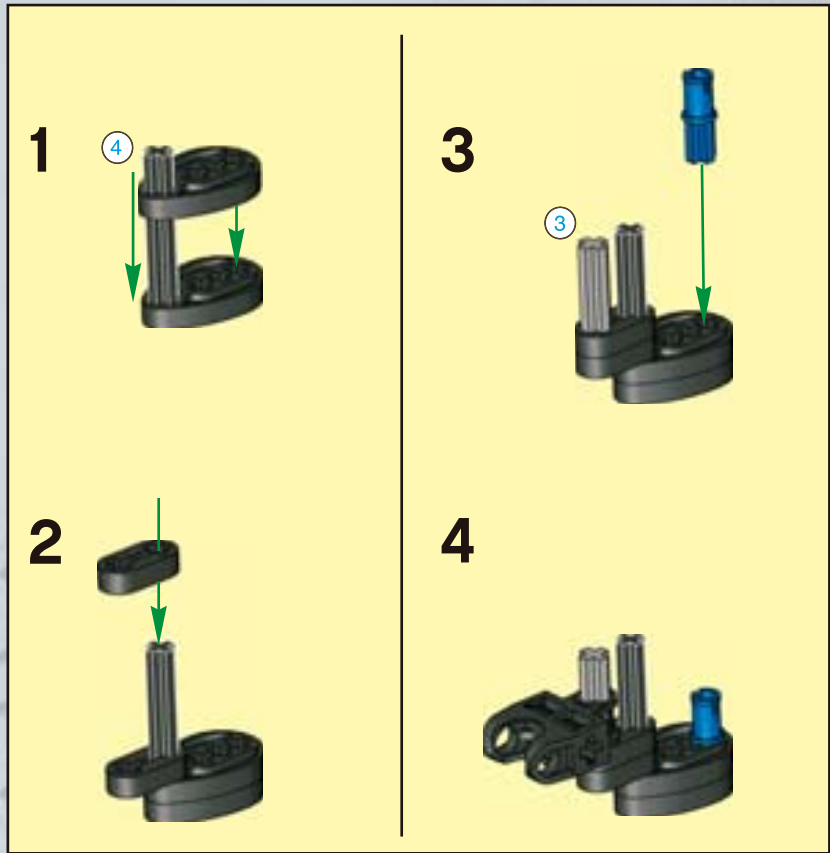



5

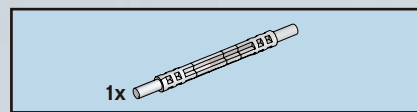
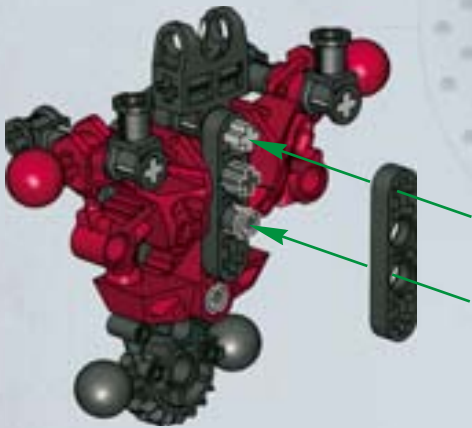

6



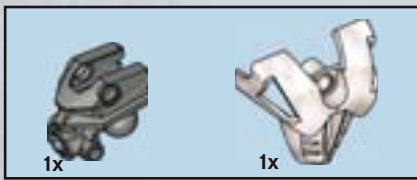

7

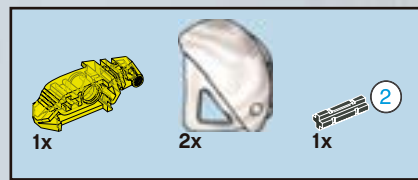

8



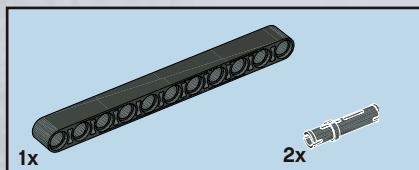

1

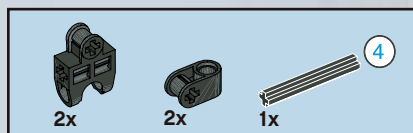

2

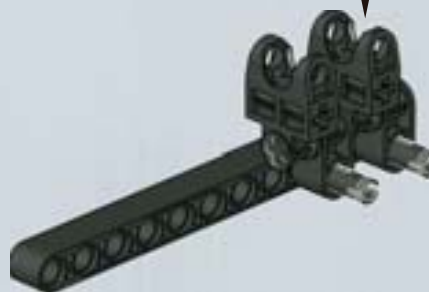
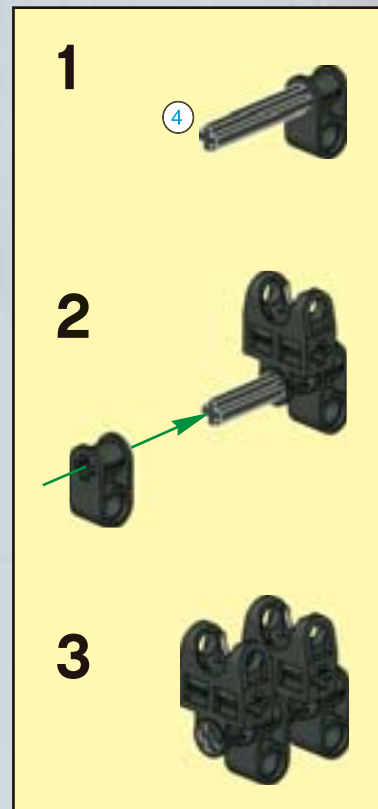

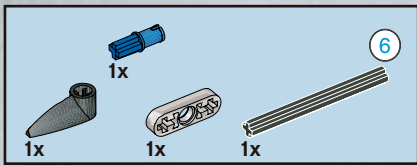

3

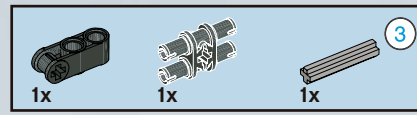
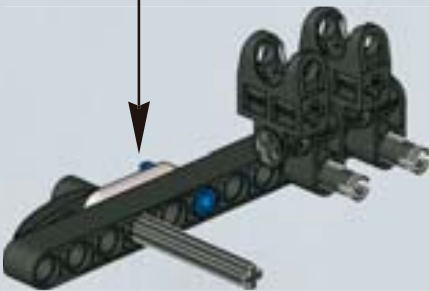
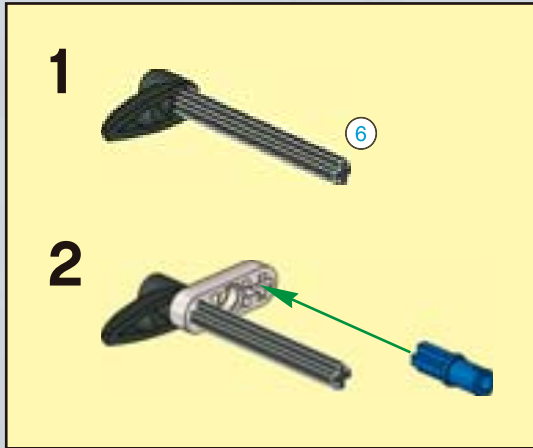

4

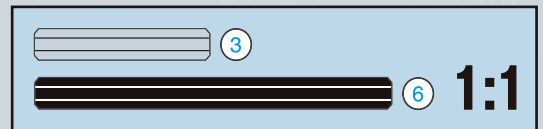
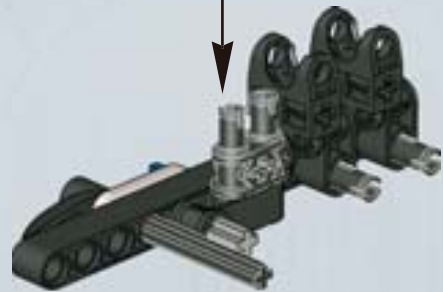
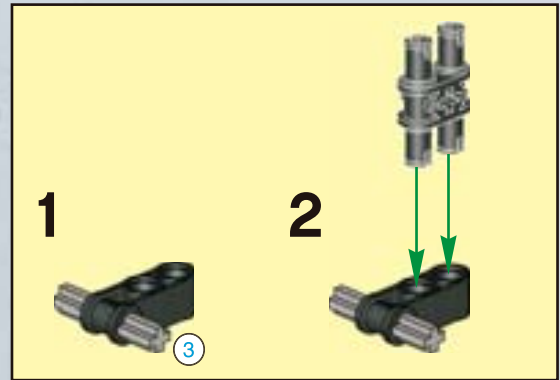



5



6

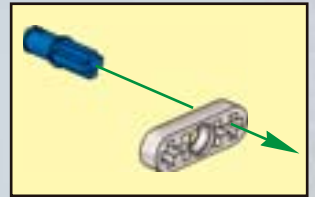
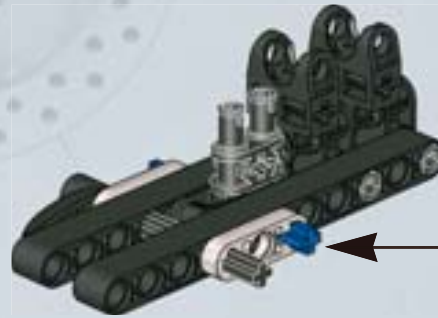



7

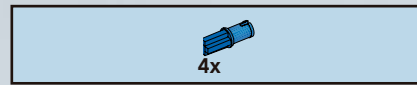

8

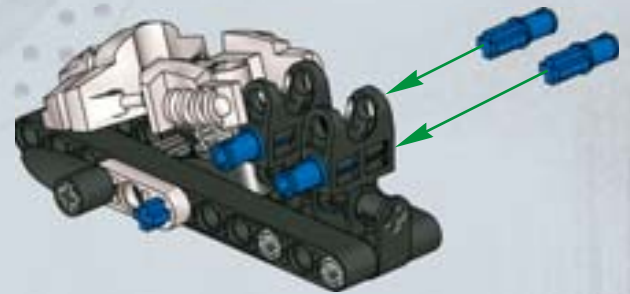

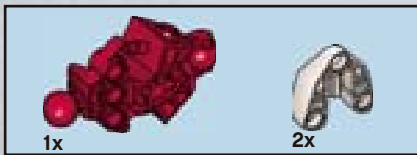

9

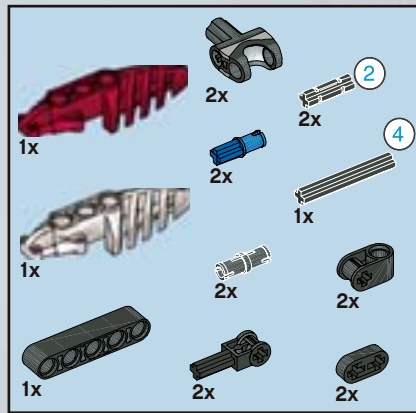
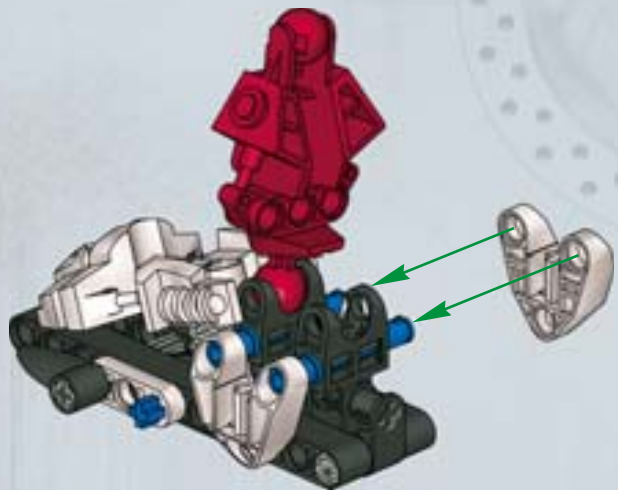

10

1

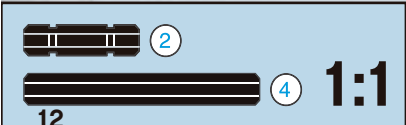

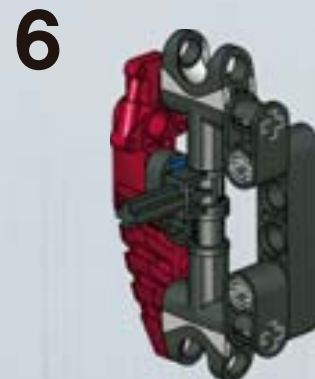
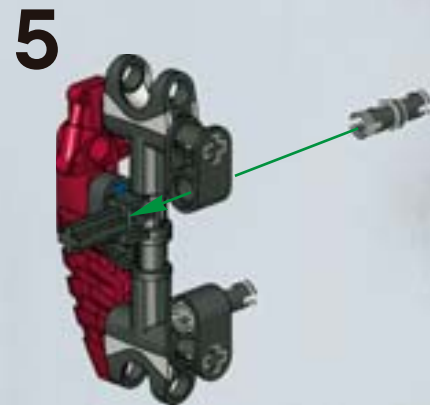
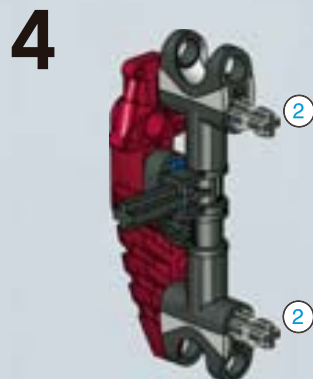

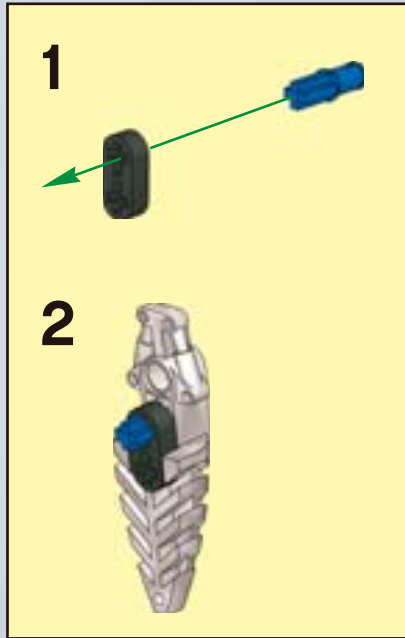

7

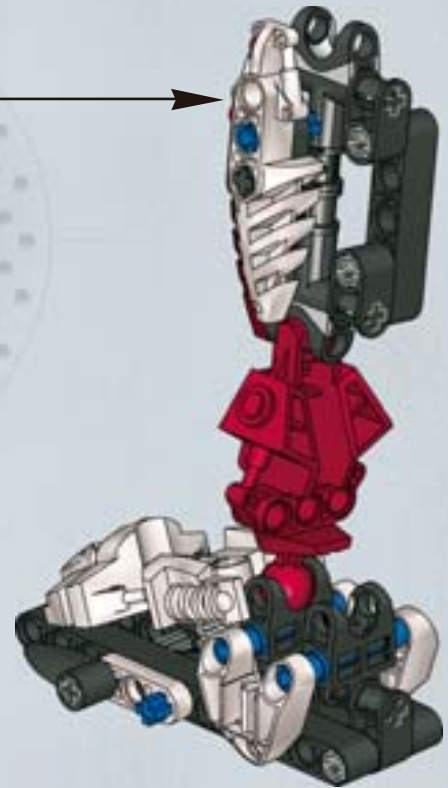

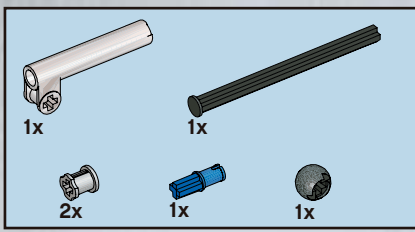

11

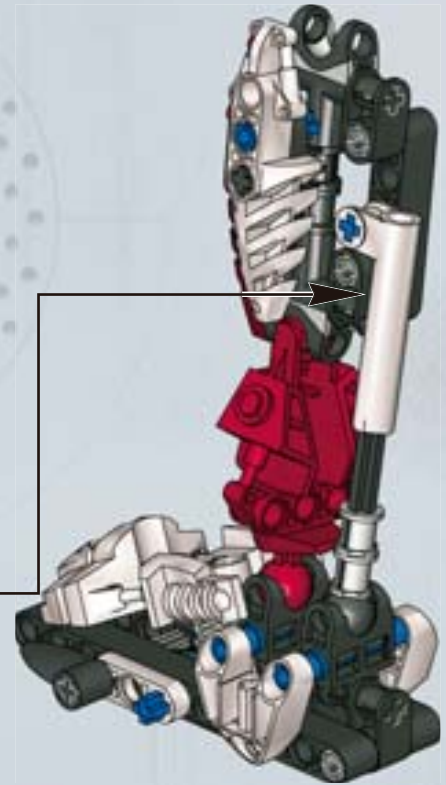
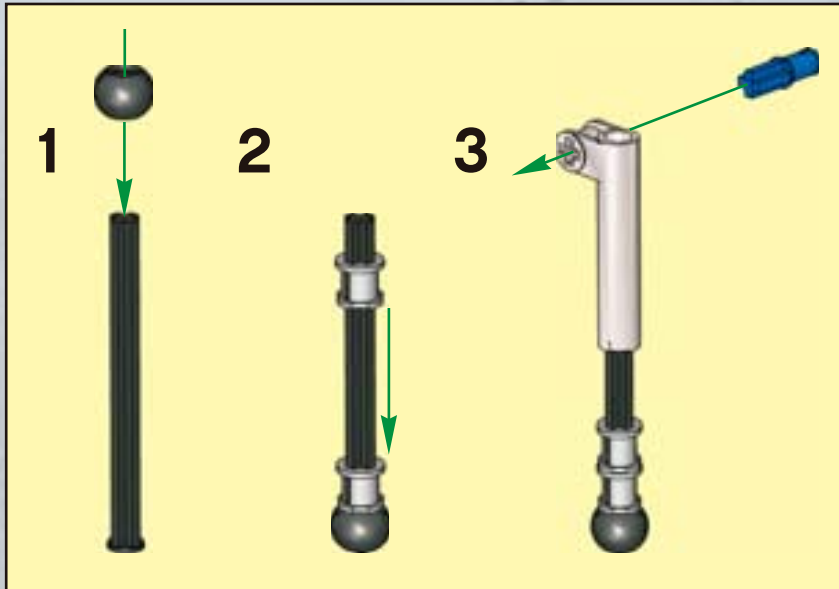

12



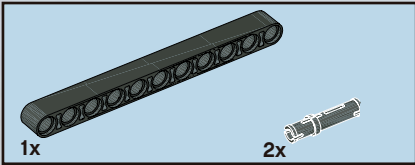

1



2

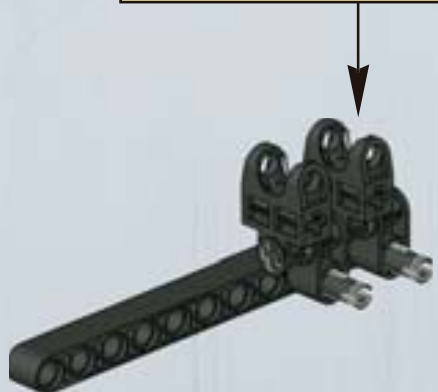
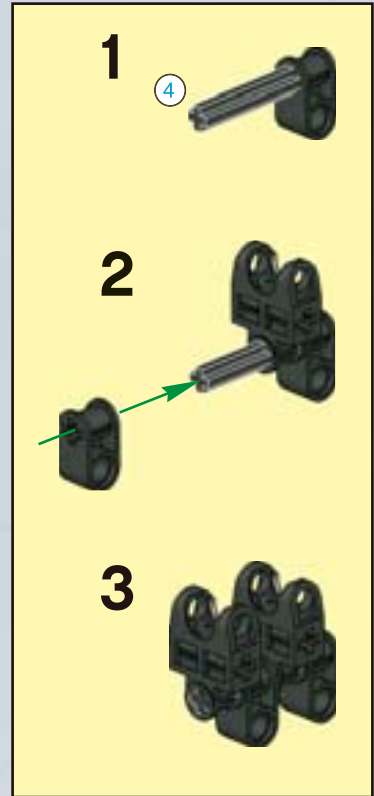

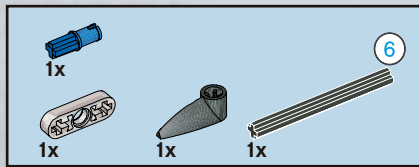

3

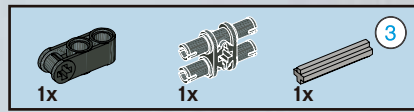
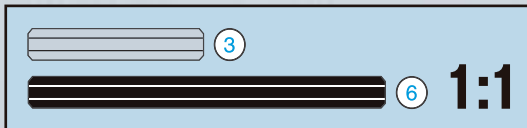
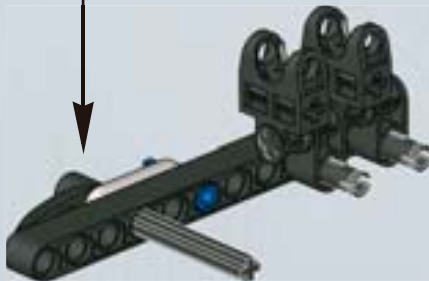
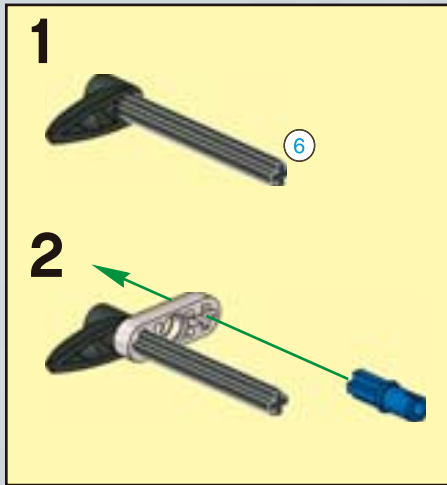

4

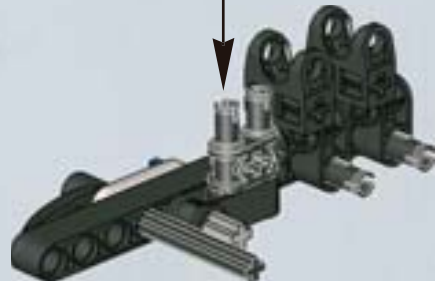
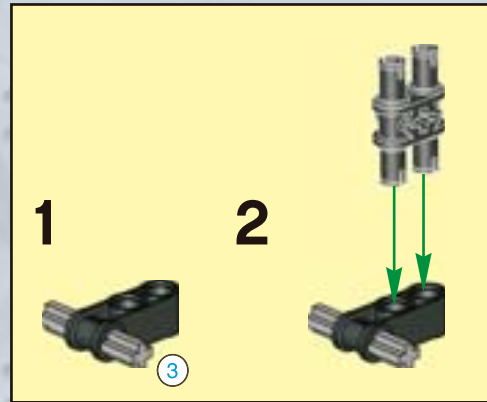

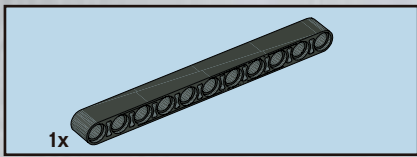

5



6

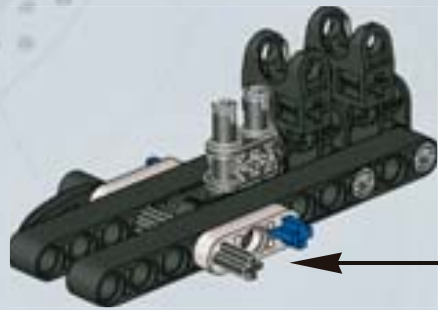
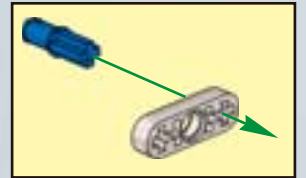



7

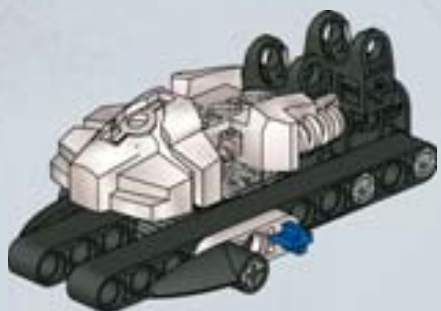

8

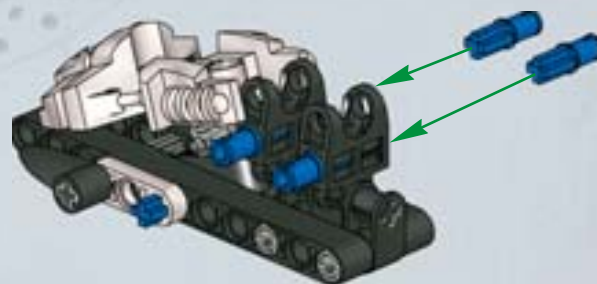

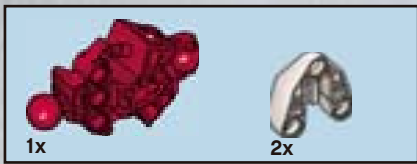

9

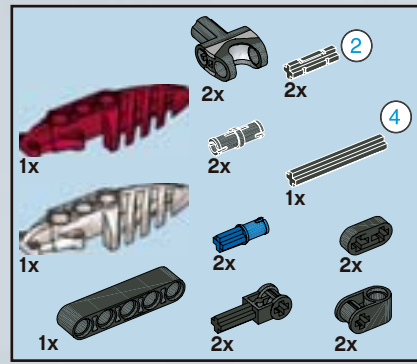
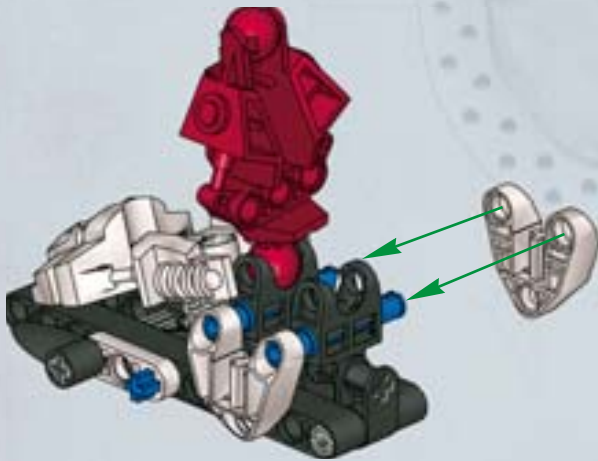

10

1





4

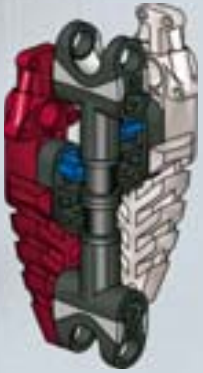

6

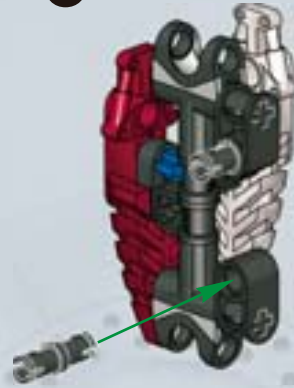

5

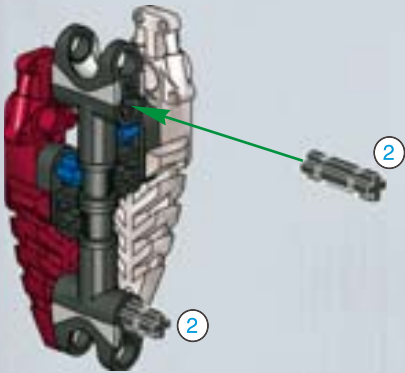

7

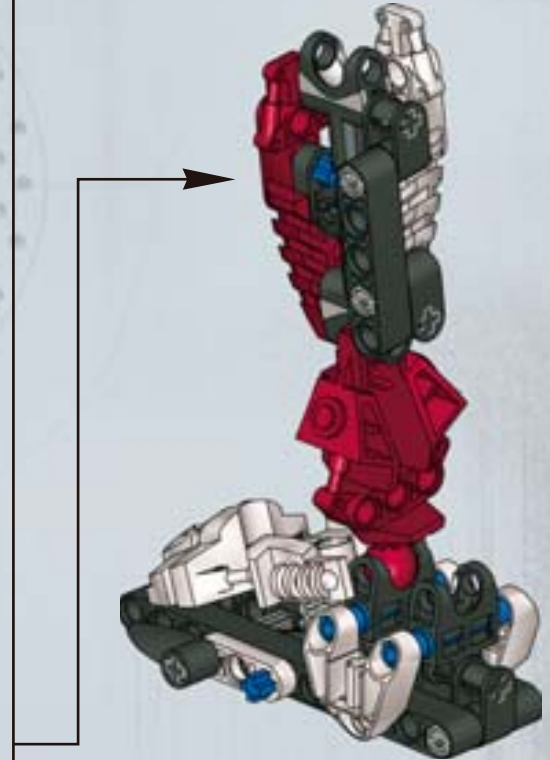
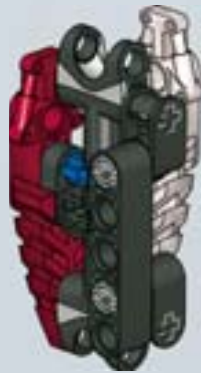

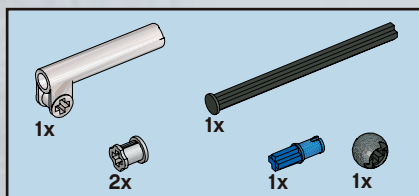

11

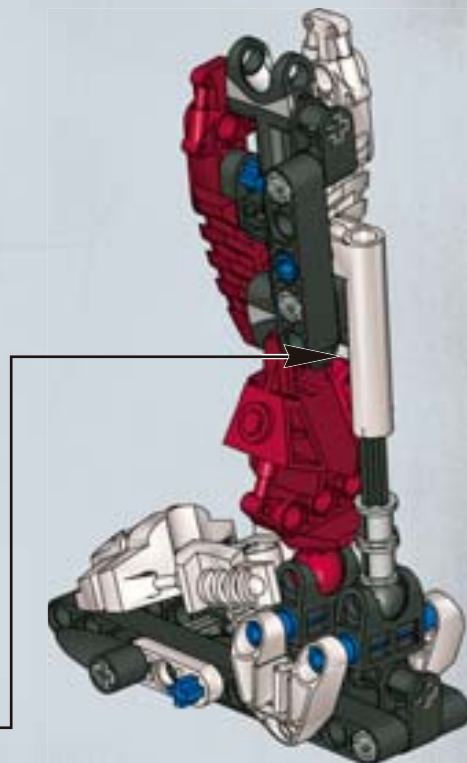
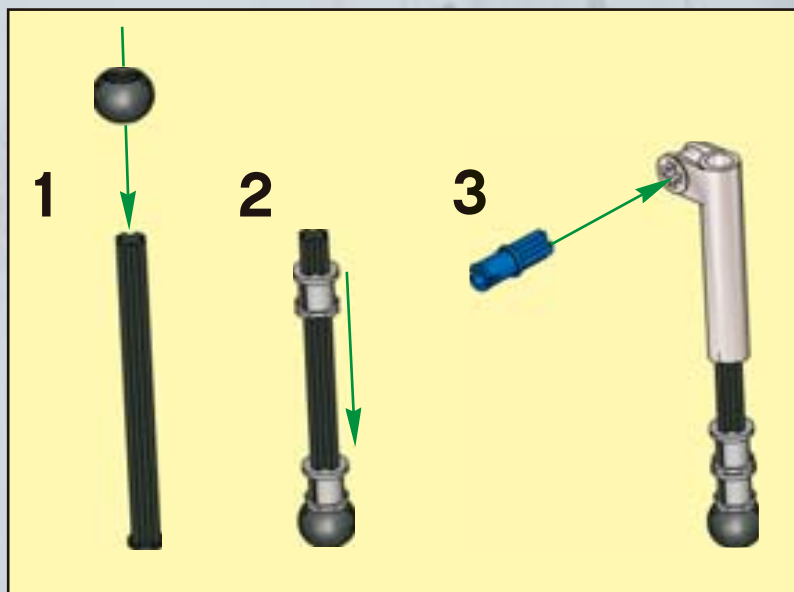

12

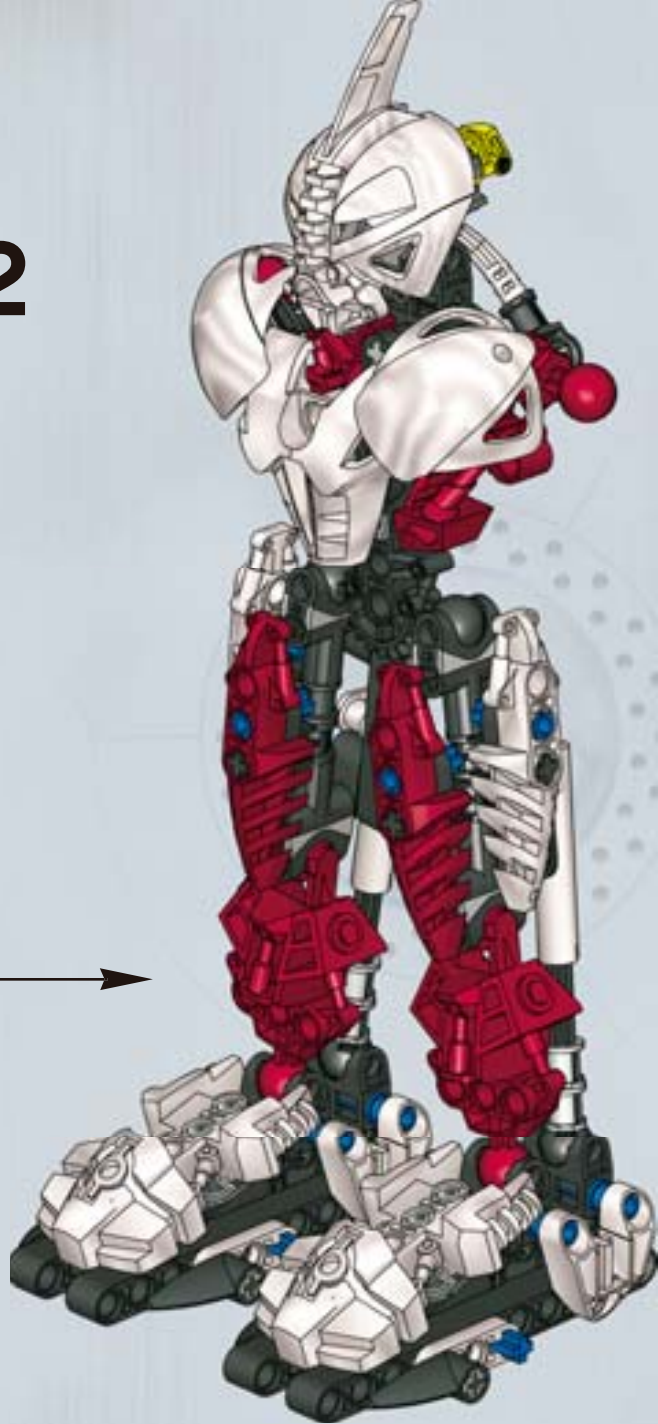

Achtung: Durch geeignete this von Befestigen vermeiden Sie das Risiko von Verletzungen. Wenn diese Befestigung nicht über ein Kind oder Baby in Ihre Hände, Augen oder Kleidung gelangt.

ATTENTION: Évitez de placer les pièces de fixation dans la main d'un enfant ou d'un bébé, dans les yeux, dans les vêtements ou dans la bouche.

ADVERTENCIA: Para evitar peligro de lesiones, mantenga estas piezas fuera de la mano de los niños o bebés, de los ojos, de la ropa o de la boca.

10000 The LEGO Group.

3

Beachte: Die passende Befestigung vermeiden Sie das Risiko von Verletzungen. Wenn diese Befestigung nicht über ein Kind oder Baby in Ihre Hände, Augen oder Kleidung gelangt.

ATTENTION: Évitez de placer les pièces de fixation dans la main d'un enfant ou d'un bébé, dans les yeux, dans les vêtements ou dans la bouche.

ADVERTENCIA: Para evitar peligro de lesiones, mantenga estas piezas fuera de la mano de los niños o bebés, de los ojos, de la ropa o de la boca.

10000 The LEGO Group.

Achtung: Durch geeignete this von Befestigen vermeiden Sie das Risiko von Verletzungen. Wenn diese Befestigung nicht über ein Kind oder Baby in Ihre Hände, Augen oder Kleidung gelangt.

ATTENTION: Évitez de placer les pièces de fixation dans la main d'un enfant ou d'un bébé, dans les yeux, dans les vêtements ou dans la bouche.

ADVERTENCIA: Para evitar peligro de lesiones, mantenga estas piezas fuera de la mano de los niños o bebés, de los ojos, de la ropa o de la boca.

10000 The LEGO Group.

3

Beachte: Die passende Befestigung vermeiden Sie das Risiko von Verletzungen. Wenn diese Befestigung nicht über ein Kind oder Baby in Ihre Hände, Augen oder Kleidung gelangt.

ATTENTION: Évitez de placer les pièces de fixation dans la main d'un enfant ou d'un bébé, dans les yeux, dans les vêtements ou dans la bouche.

ADVERTENCIA: Para evitar peligro de lesiones, mantenga estas piezas fuera de la mano de los niños o bebés, de los ojos, de la ropa o de la boca.

10000 The LEGO Group.

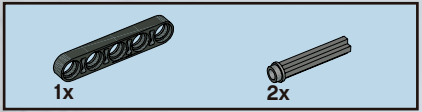
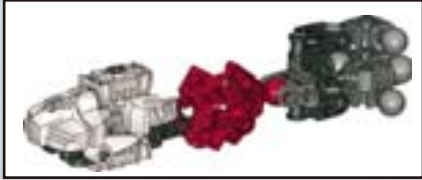

1

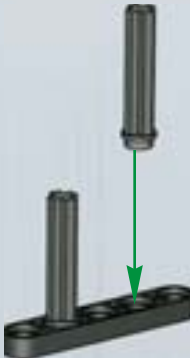

2x

2



1x

3



1:1



4

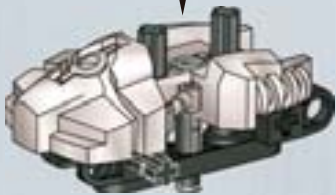
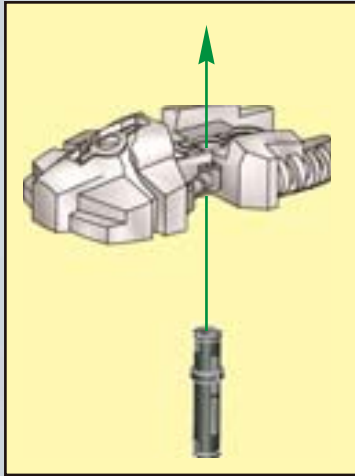

5

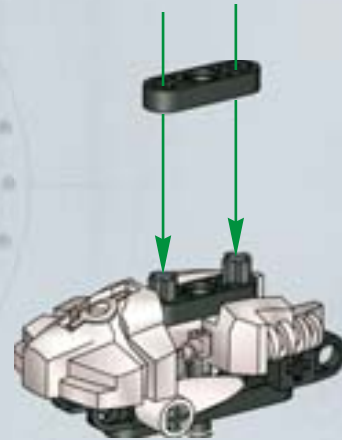



6

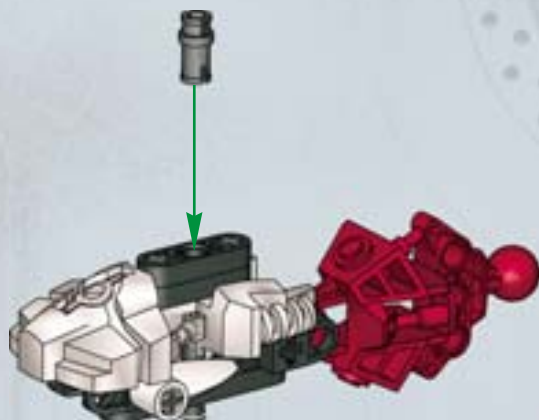

7

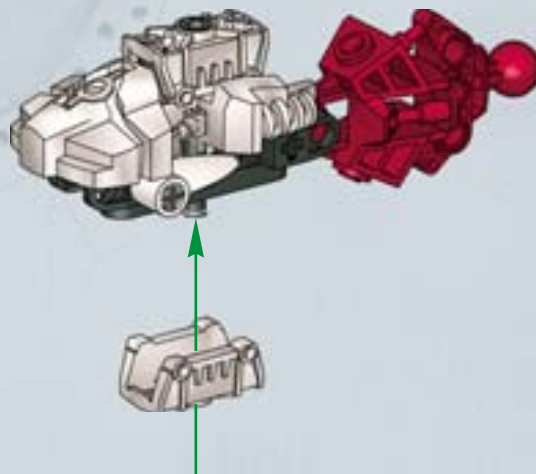

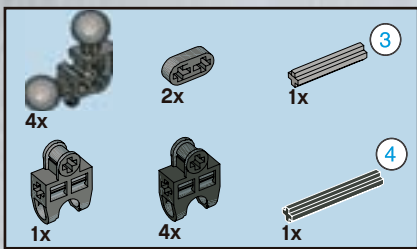

8

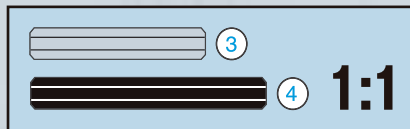
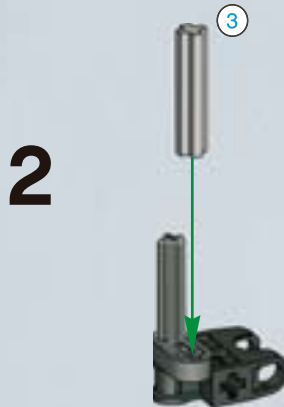

3



4

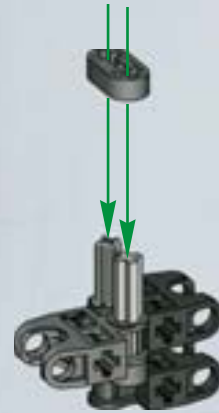

5



6



7

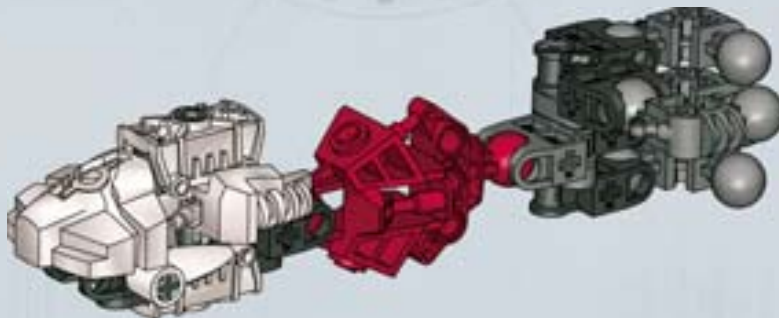

9

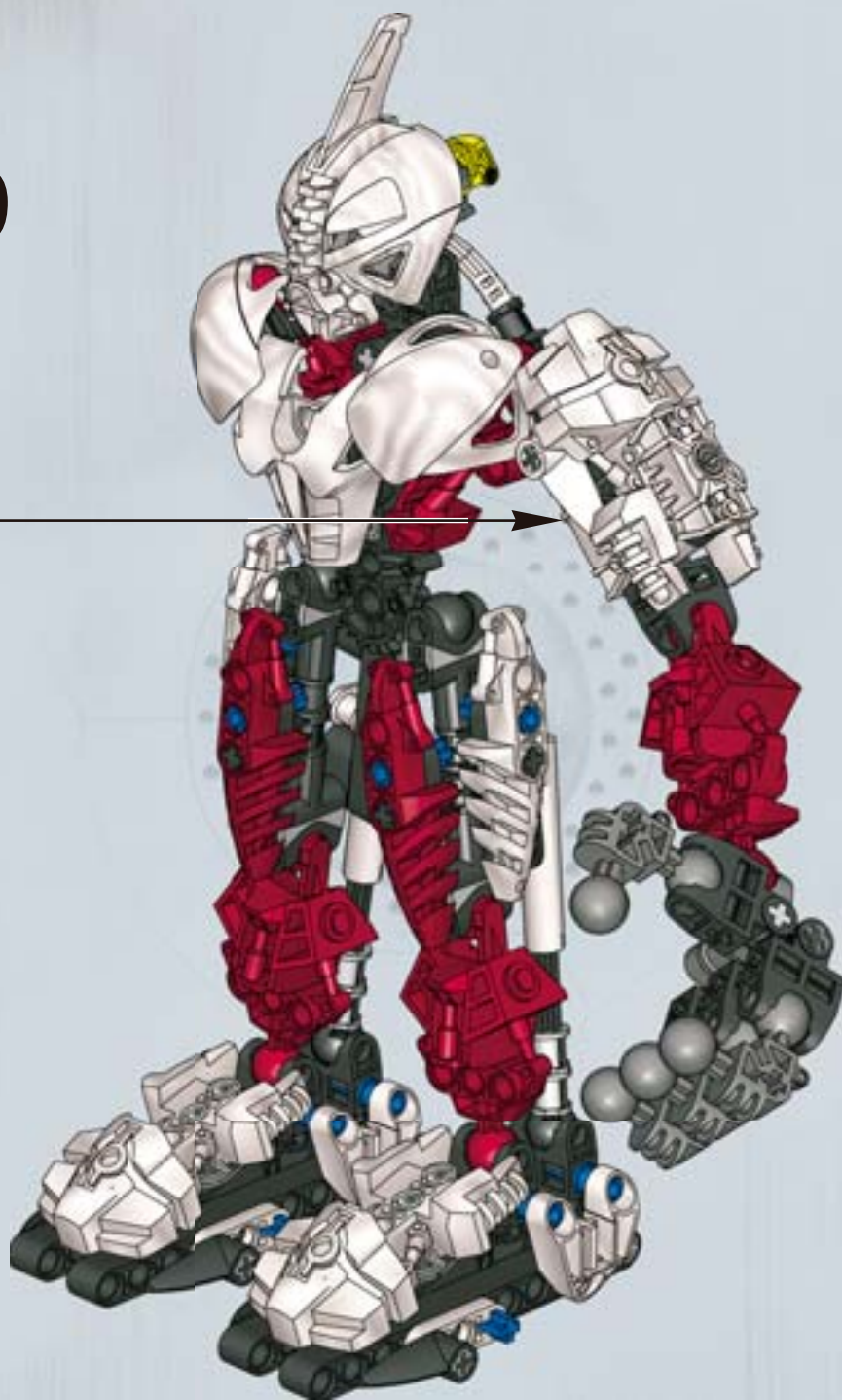



1

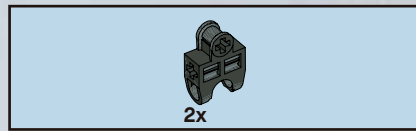
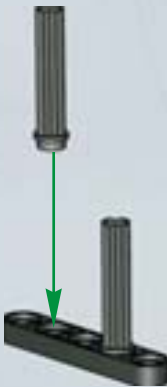

2

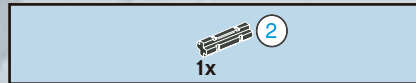

3





4

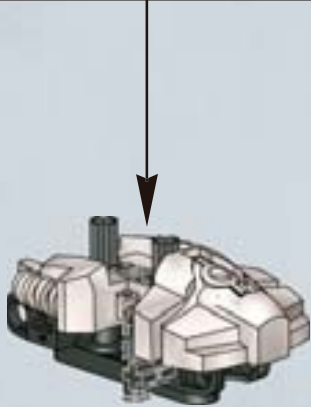
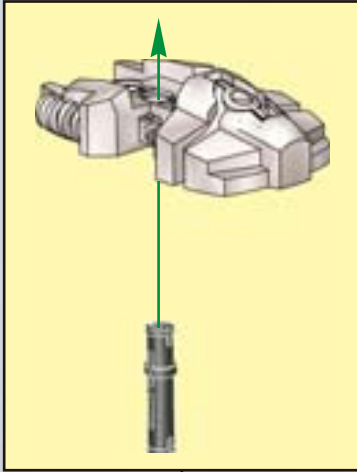

5

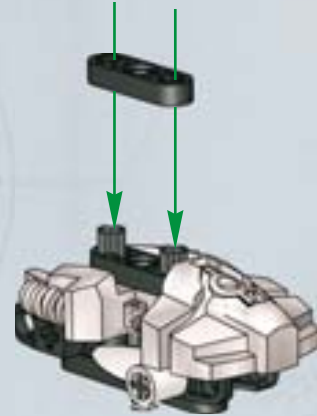

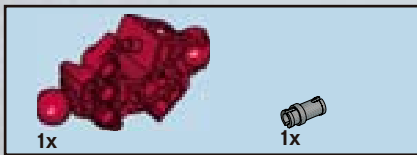

6

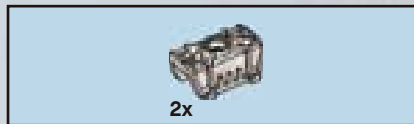
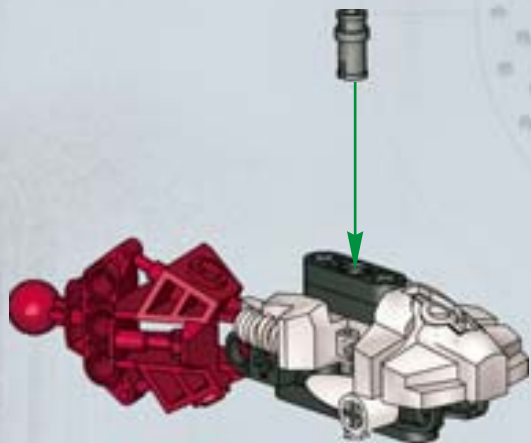

7

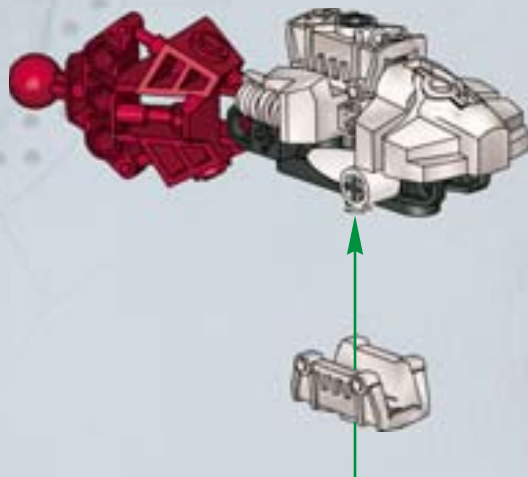

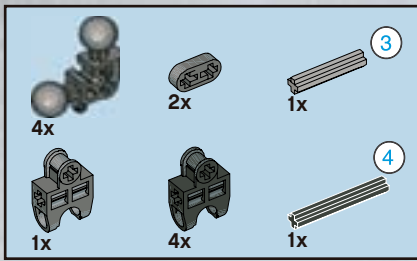

8

1

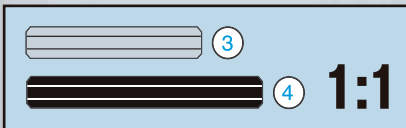

2

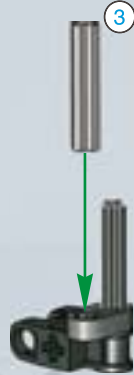

3

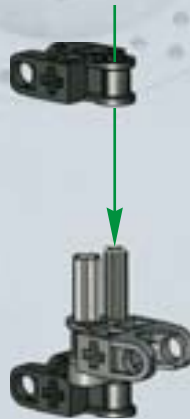

4

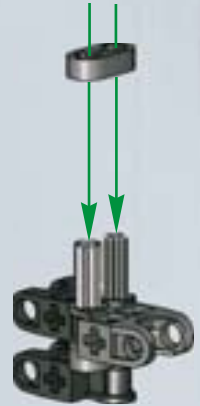

5



6



7



9

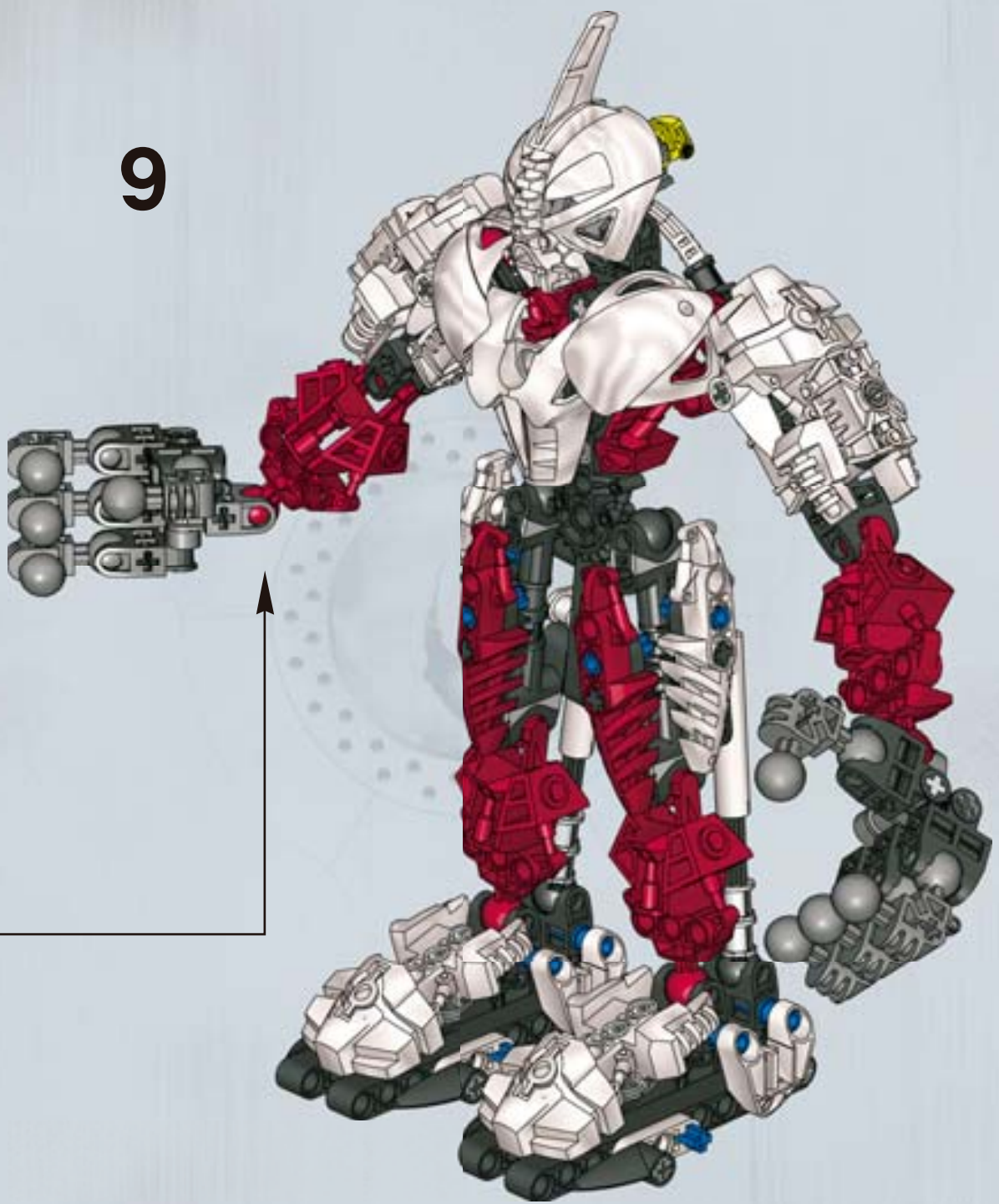

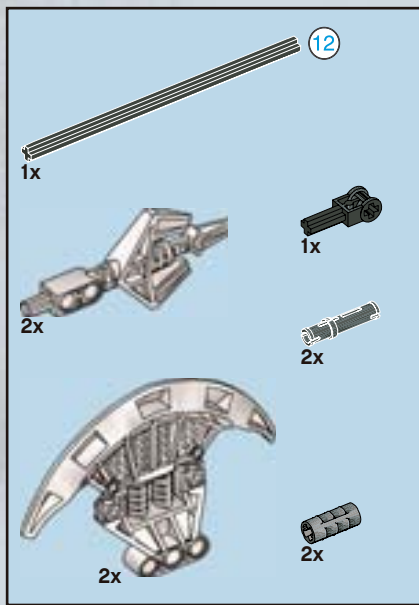

10

1



2



3



4



5



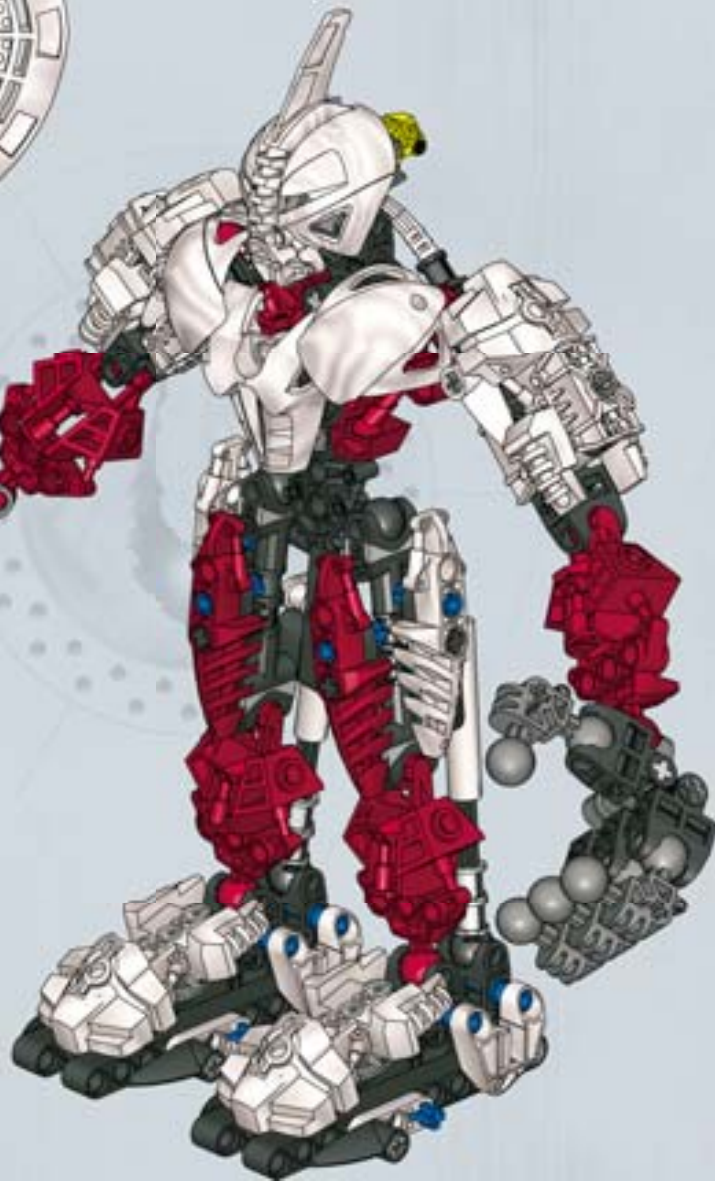
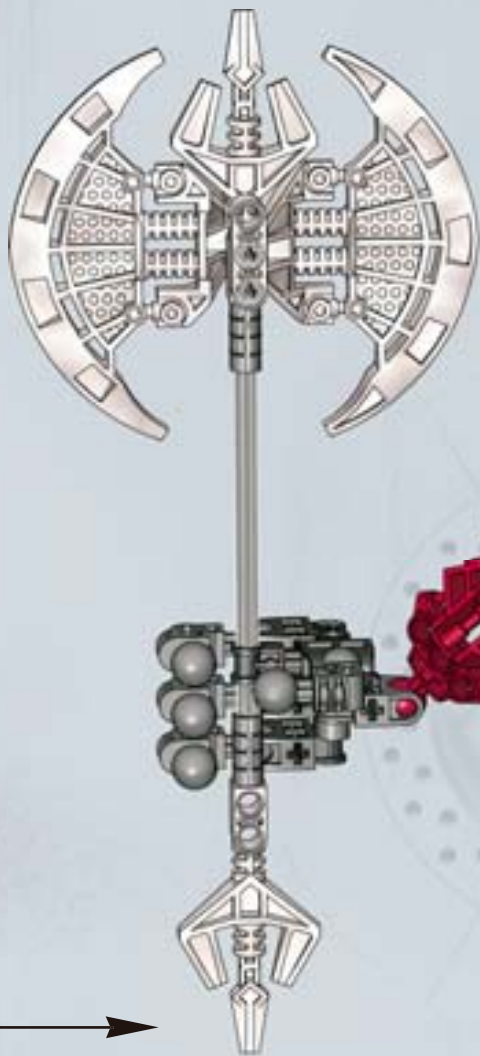



1x
4285866



2x
4284480

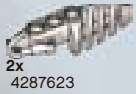

2x
4287623



4x
4285684

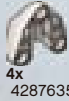

4x
4287635



2x
4286268



1x
4286266



4x
4285683



2x
4285865

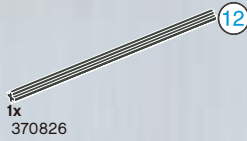

1x
370826

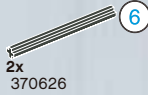

2x
370626



7x
370526



7x
4109810



4x
4287625



2x
4287617



2x
4279767



2x
4252397



1x
4286264



4x
4289379



4x
4235786

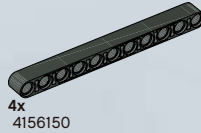

4x
4156150



2x
4142135



2x
4106380



6x
4164133



4x
4107828



2x
4142236



1x
4278585



4x
4177441



8x
4173668



2x
4173970



2x
4288089



2x
4286267



17x
4119328



2x
4119589



5x
4121715



9x
655826



5x
4107765



4x
4107081



2x
4143187

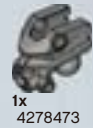

1x
4278473

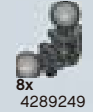

8x
4289249



2x
4217829



4x
4210980

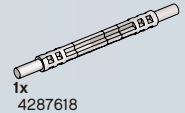

1x
4287618

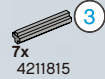

7x
4211815



2x
4211050



4x
4211086



2x
4210672



1x
4238920



4x
4211622



19x
4206482



WWW.BIONICLE.COM



8734 BRUTAKA



8733 AXONN

8734 + 8733



BRUTAKA

8734

BIONICLE
PRESENTS
PIRAKA
THE GANG IS ON THE LOOSE



8904 AVAK Ⓢ 8903 ZAKTAN Ⓢ 8901 HAKANN Ⓢ 8902 VEZOK Ⓢ 8905 THOK Ⓢ 8900 REIDAK Ⓢ



AUGUST 2006
Août 2006
Agosto 2006

VEZON & FENRAKK
B764



club

Win! Gagne !

FREE! Each LEGO Magazine Features...
• Awesome creations by Kids like you!
• Cool Comics & Stories
• Building Tips & Ideas
• Special Offers & Contests to WIN Prizes!

GRATUIT !

Chaque Magazine LEGO offre...
• Des créations épatantes par des jeunes comme toi !
• Des bandes dessinées et des récits super cool
• Des idées de construction
• Des offres spéciales et des concours pour gagner des prix !

Join Today! Abonne-toi dès aujourd'hui !

1-866-534-6258

www.LEGOclub.com



LEGO, the LEGO logo are trademarks of/sont des marques de commerce de/The LEGO Group. ©2005 The LEGO Group.

WIN LEGO® PRODUCTS

Log on to www.acnielsen.aim.dk/LEGO for further instructions.

GAGNE DES PRODUITS LEGO®

Visite www.acnielsen.aim.dk/LEGO pour plus d'informations.

ESTIMADO USARIO LEGO®

Al contestar algunas preguntas en ingles, frances, aleman o japones en el sitio www.acnielsen.aim.dk/LEGO, podras participar en el sorteo de algunas valiosos premios LEGO®.

www.acnielsen.aim.dk/LEGO



YES! I WANT TO JOIN THE LEGO® CLUB!

This coupon is good for 1 **FREE** 2-year Club membership. Additional kids may sign up for \$7.95 in the US and in Canada 10.70 (including taxes).

PLEASE PRINT IN ALL CAPITAL LETTERS

OUI!! JOIGNEZ-MOI AU CLUB LEGO® !

Ce coupon est valide pour 1 abonnement **GRATUIT** de 2 ans. Enfants additionnels peuvent s'inscrire pour 10,70 \$ (taxes incluses).

S.V.P. IMPRIMER EN LETTRES MAJUSCULES.

BIC26

Name/Nom _____ Age _____ Français English

Address/Adresse _____ Girl/Fille Boy/Garçon

City/Ville _____ State/Prov. _____ Postal Code Code Postal _____

E-mail Address/Courriel _____ Date of Birth Date de Naissance _____
M / D/J / Y/A

Parent's Signature/Signature d'un parent _____

Mail to/Poster à:
LEGO Club
P. O. Box 1157
Enfield, CT 06083-1157



Offer limited to residents of US and Canada. No photocopies will be accepted. Offer limited to two free memberships per family, group or organization. Please allow 4-6 weeks for delivery of your first mailing.

Offre limitée pour résidents du US et Canada. Photocopies ne seront pas acceptées. Offre limitée à deux abonnements gratuits par famille, groupe, ou organisation. Attendez 4-6 semaines pour la première livraison.

**FREE
LEGO Magazine
with this coupon!
Magazines LEGO
GRATUITS
avec ce coupon !**



SHOP at HOME

The World's Biggest LEGO® Shop!



**For a Free Catalog in the U.S.
and Canada, call toll-free:
1-866-534-6737
Or go online:
www.LEGOshop.com/catalog**

**Pour obtenir un Catalogue GRATUIT
aux États-Unis et au Canada,
téléphonez sans frais au :
1-866-534-6737
Ou venez en ligne sur :
www.LEGOshop.com/catalog**

Any questions
regarding
your new
LEGO
product,
please contact:
Customer Service

| Service
Consom-
mateurs |
Servicio :



1-800-422-5346

or

www.lego.com/service



LEGO, the LEGO logo are trademarks of the LEGO Group. ©2005 The LEGO Group.



FREE LEGO® Catalog!

Please print with a pen in capital letters.

First Name
Prénom _____

Last Name
Nom _____

Address
Adresse _____

City
Ville _____ State
Prov _____ Zip Code
Code Postal _____

Phone (optional)
No de téléphone
(optionnel) _____

Email (optional)
Courriel (optionnel) _____

Check Below / Indiquer ci-bas

- I speak English Je parle Français Boy/Garçon Girl/Fille

Catalogue LEGO® Gratuit!

S.V.P. Écrire en lettres majuscules avec un stylo à bille noir.



Mail to/Poster à:



SHOP at HOME

**P. O. Box 1221
EnField, CT 06083-1221**



Please allow 2-4 weeks for delivery.
Veuillez s.v.p. allouer 2 à 4
semaines pour l'expédition.



BIONICLE® Heroes. Available winter 2006/2007
Les héros BIONICLE®. Disponibles à l'hiver 2006/2007
BIONICLE® Heroes. Disponible en invierno de 2006/2007



WWW.BIONICLE.COM