

Spider1 Bot

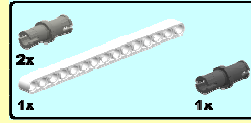

Building Instructions

1. Building the left side legs subassembly



1

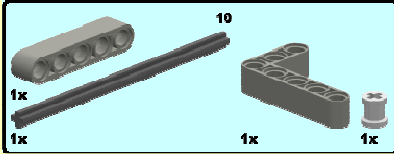

2



Turn around



3

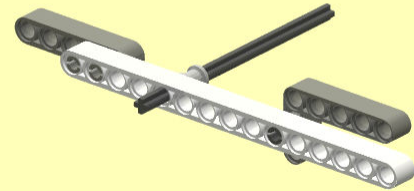

4

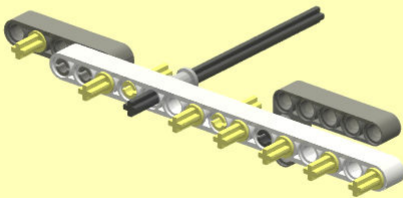

5

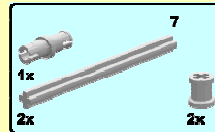
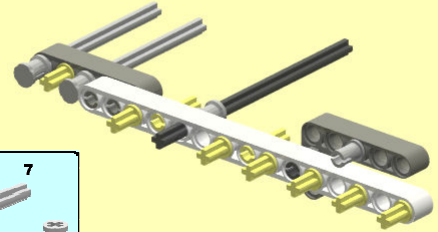

7

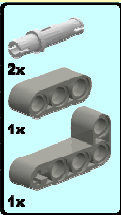
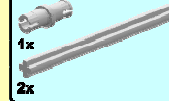

6

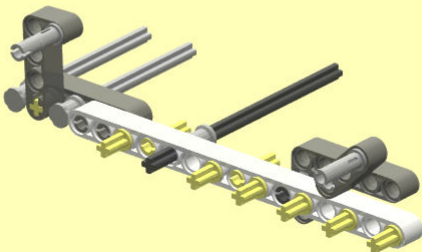

7

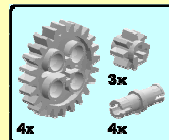
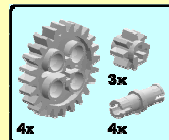

8

Turn around

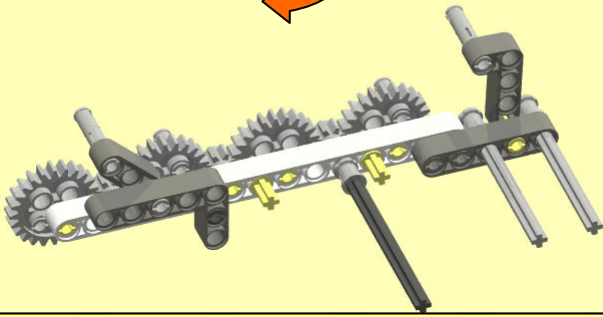

9

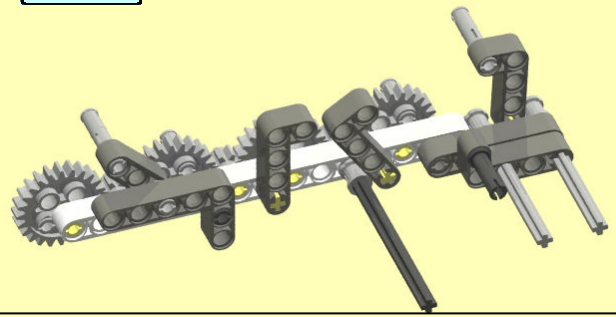
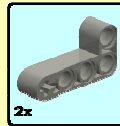

10

Turn around

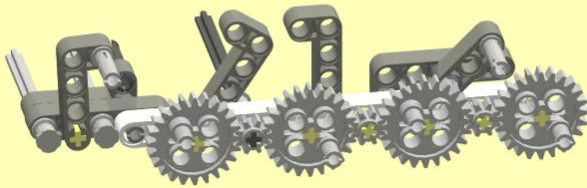

11

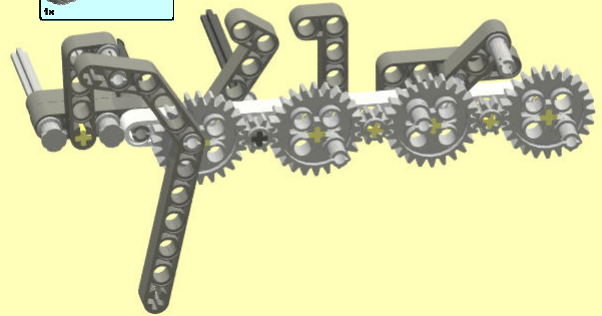
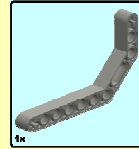

Reposition

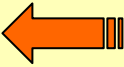

12

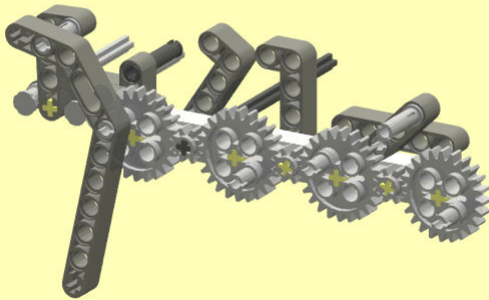

13

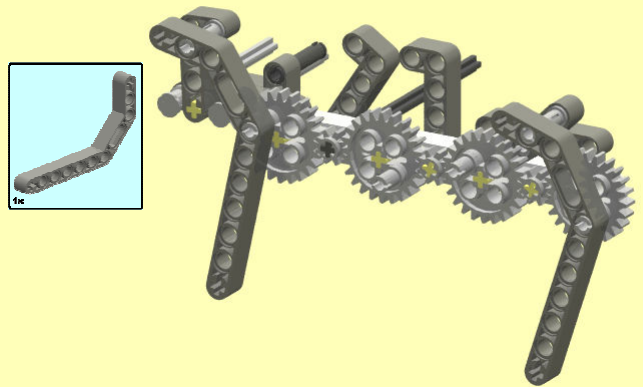
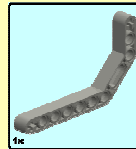

Reposition

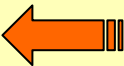

14

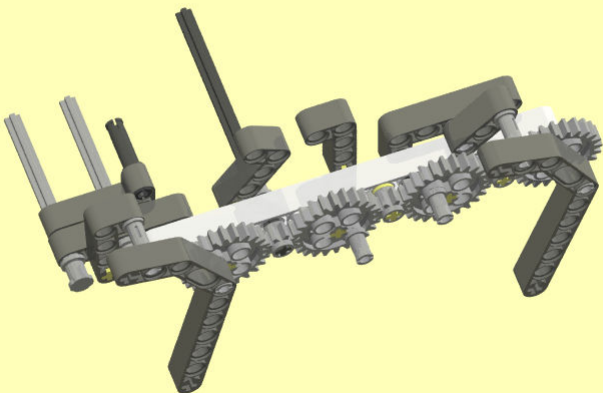

15

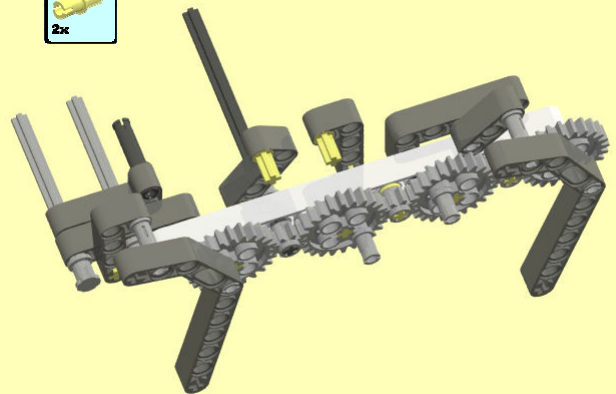

16

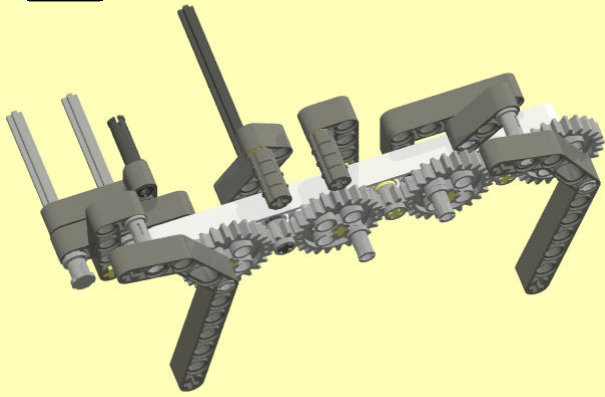

17

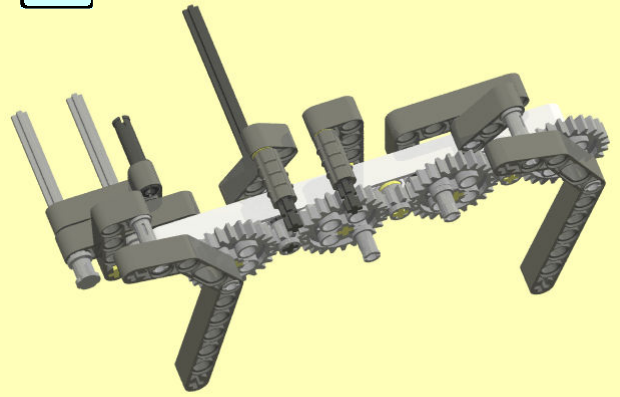

Reposition

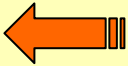

18

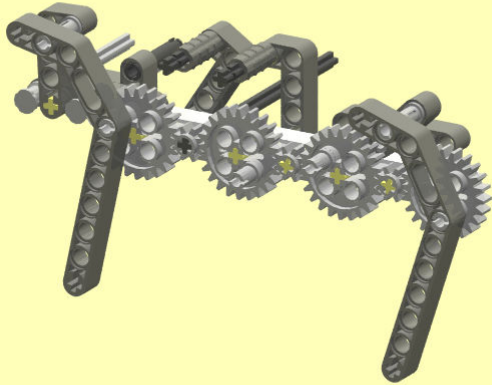

19

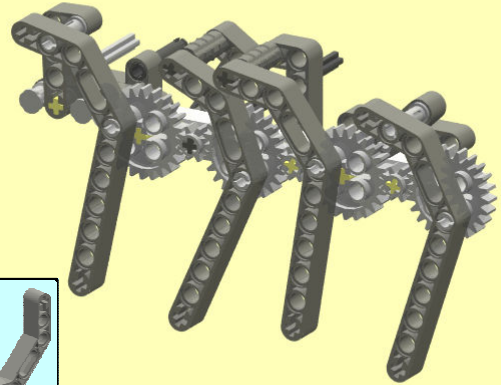
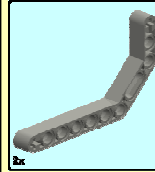

2. Building the right side legs subassembly

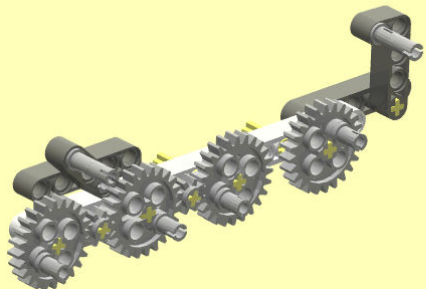
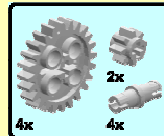
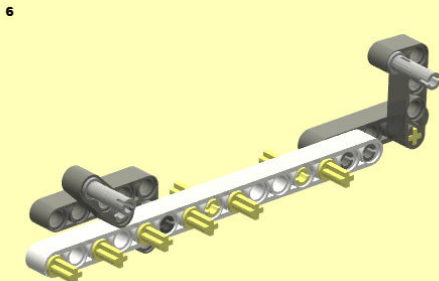
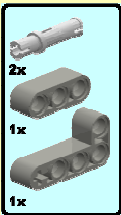
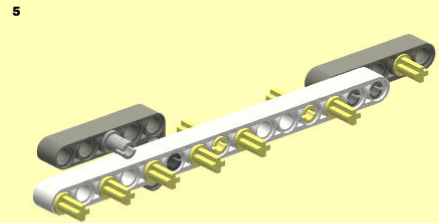
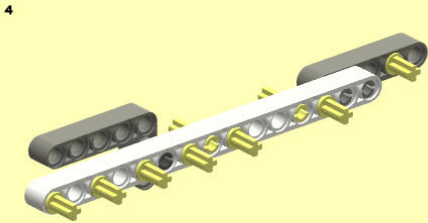
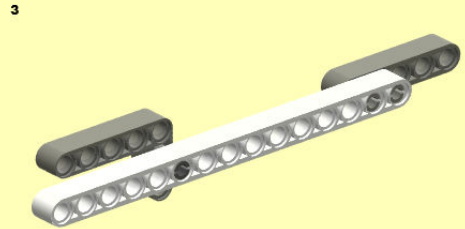
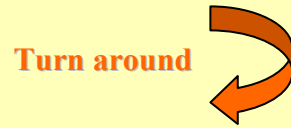
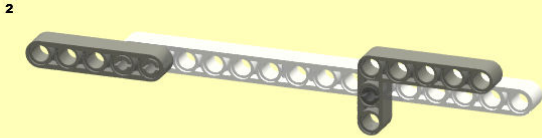
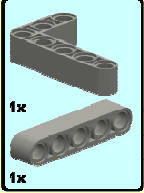
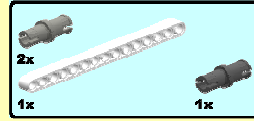
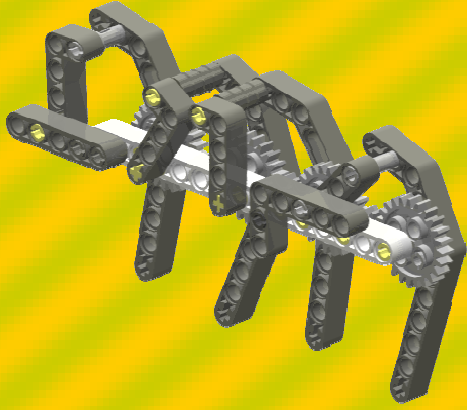

Turn around



8

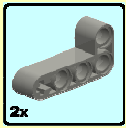
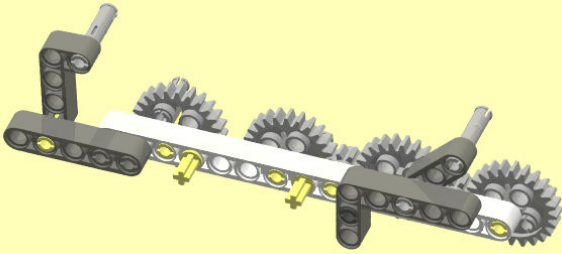

9

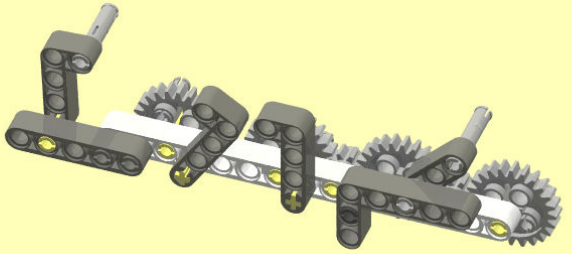

Turn around



10

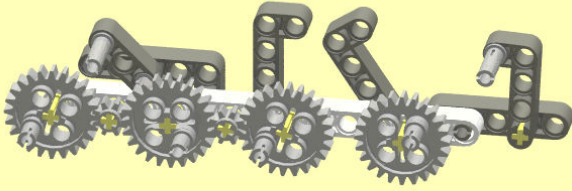

11

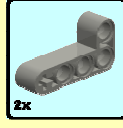
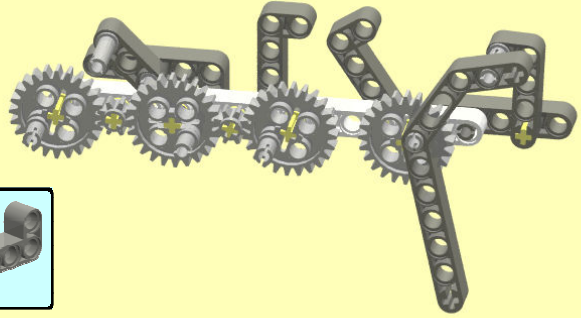

Reposition

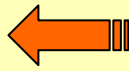

12

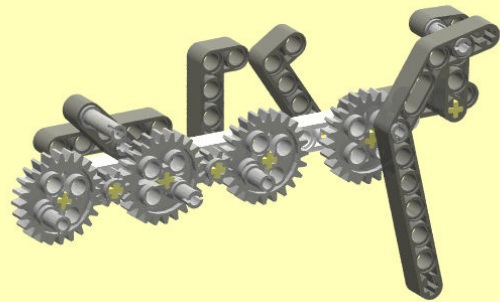

13

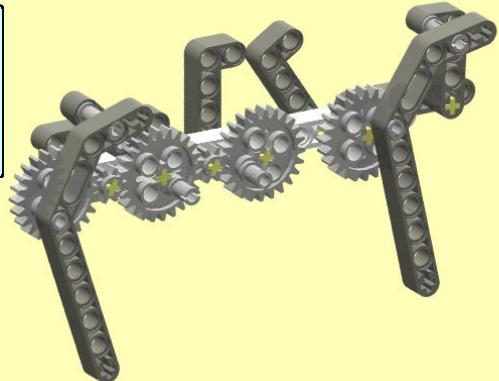
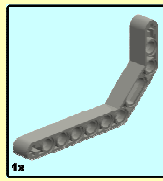

Reposition

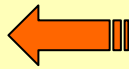

14

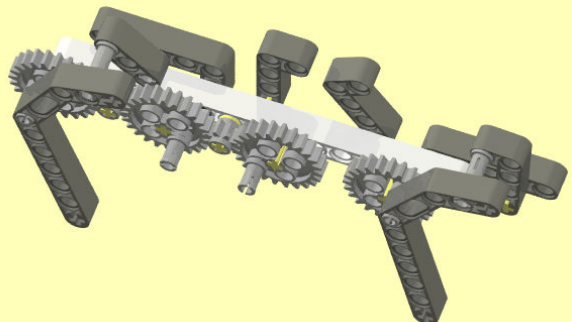

15

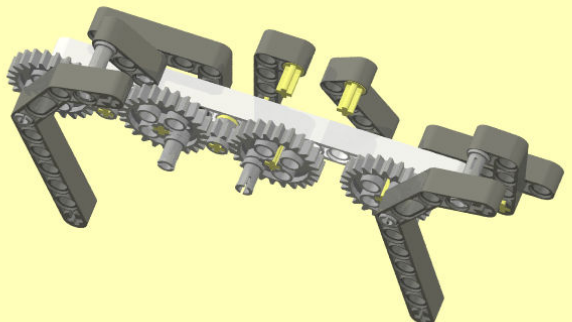



16

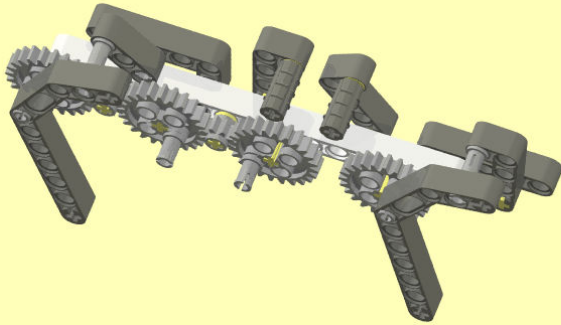

17

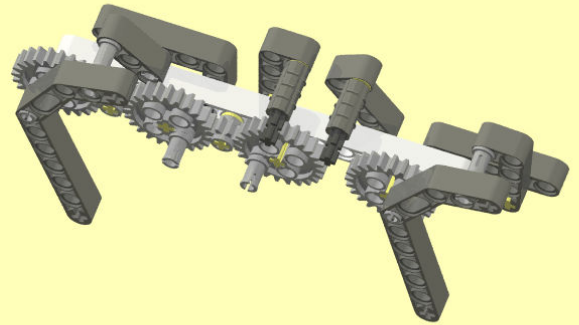

Reposition

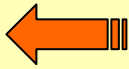

18

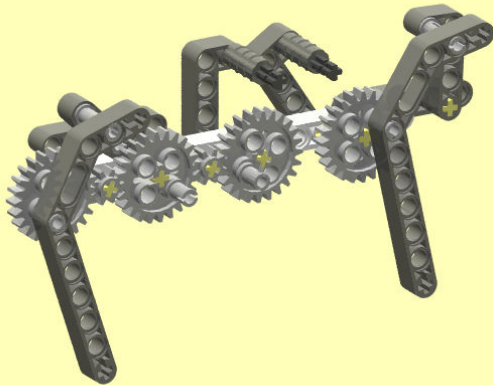

19

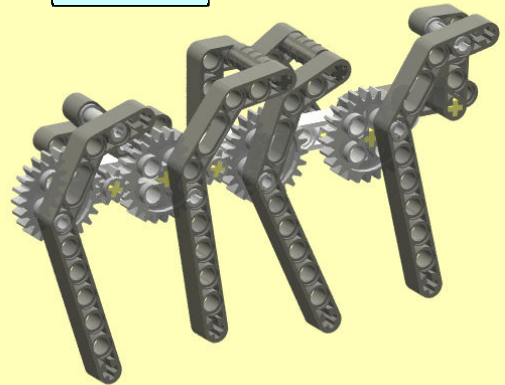
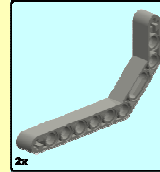

3. Building the body



1

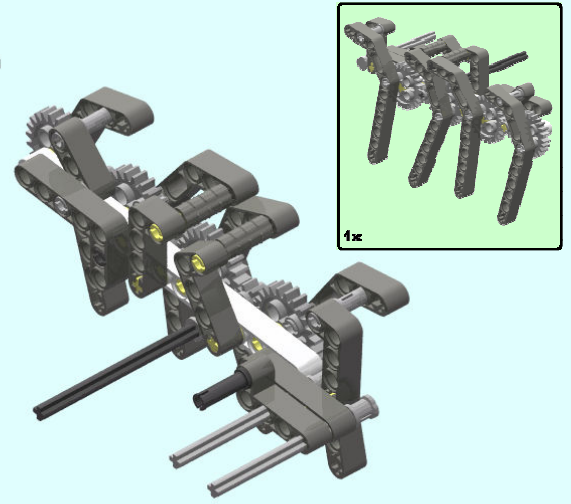

2

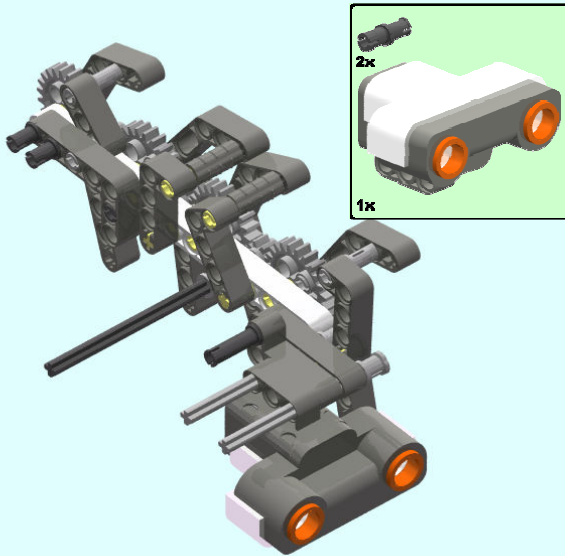

3

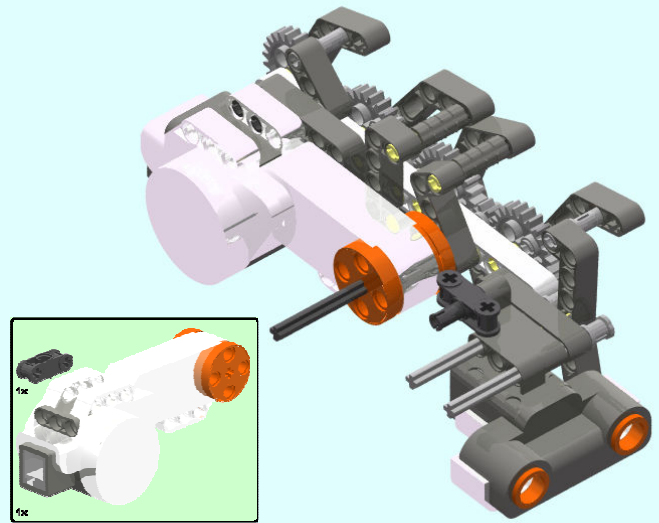

4

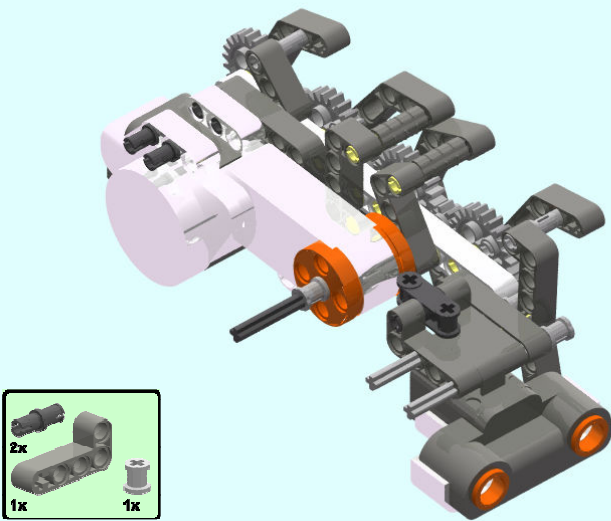

5

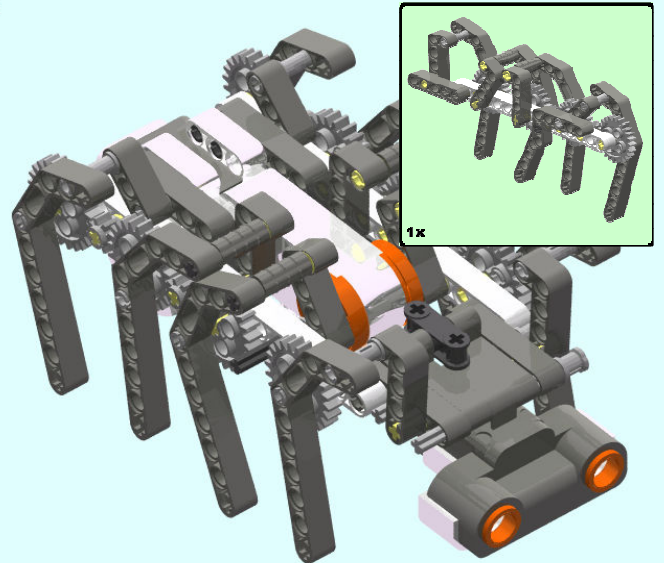

6

Reposition

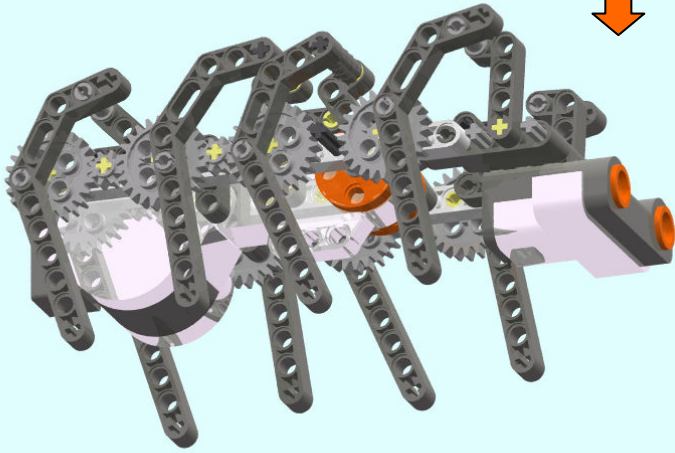

7

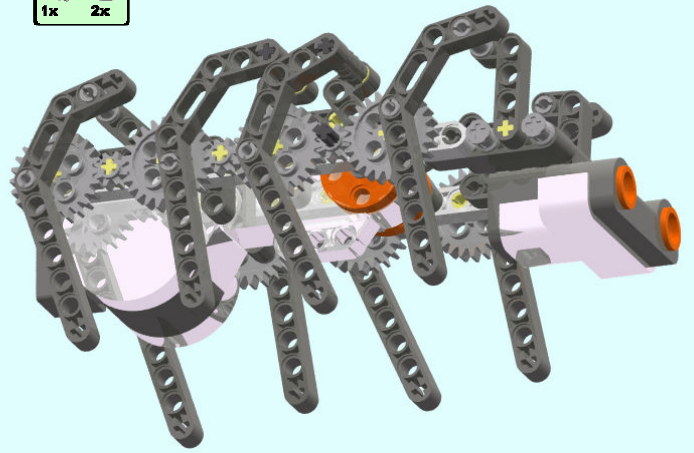

8

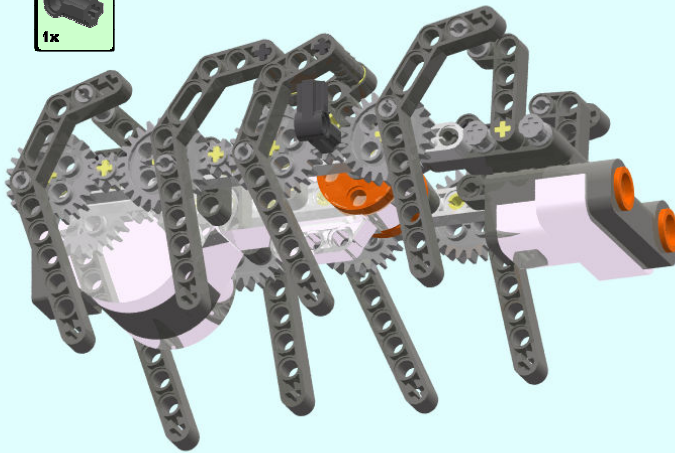

9

Reposition

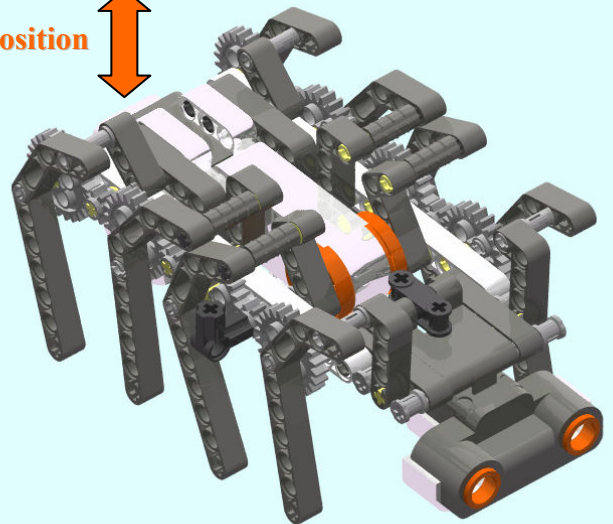

10

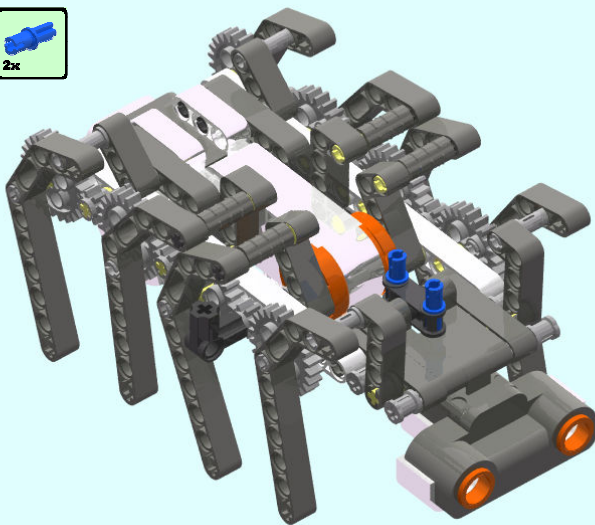

11

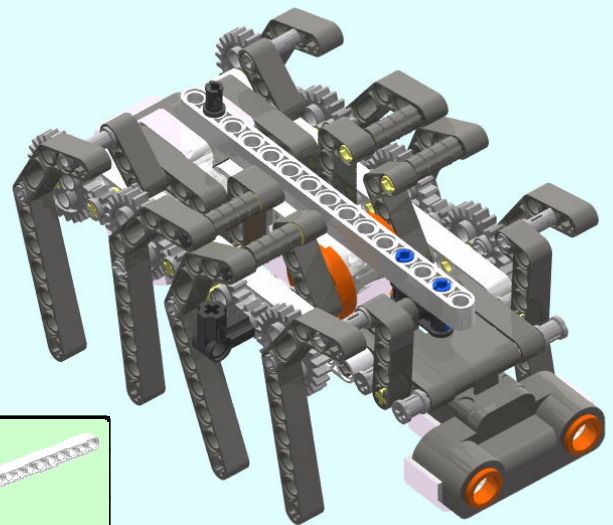
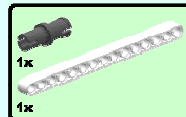

12

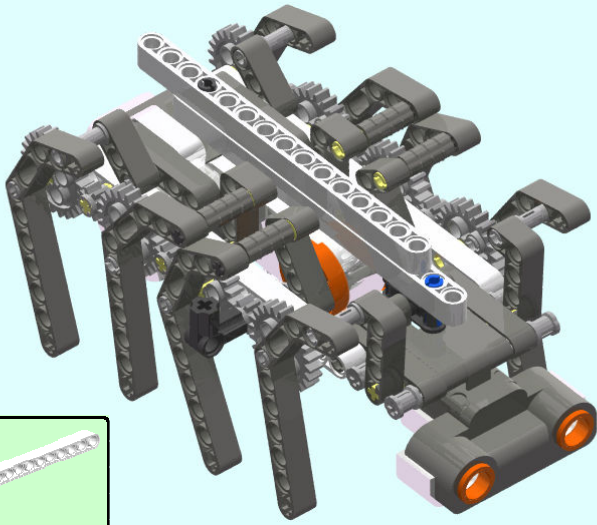

13

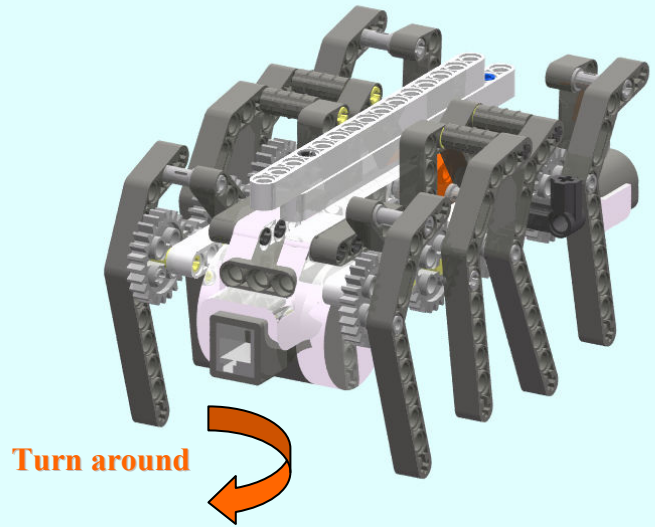

14

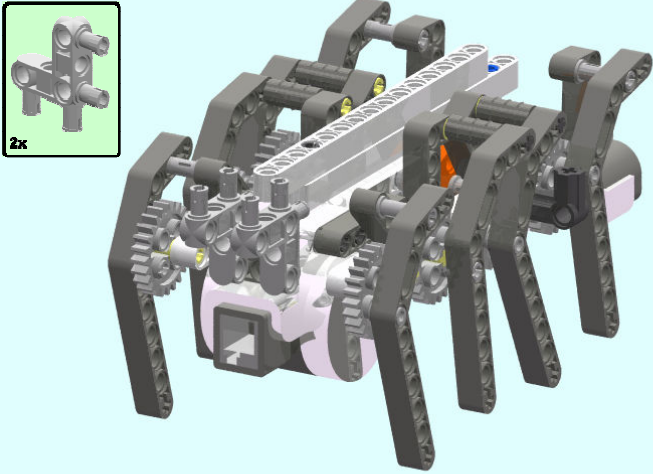

15

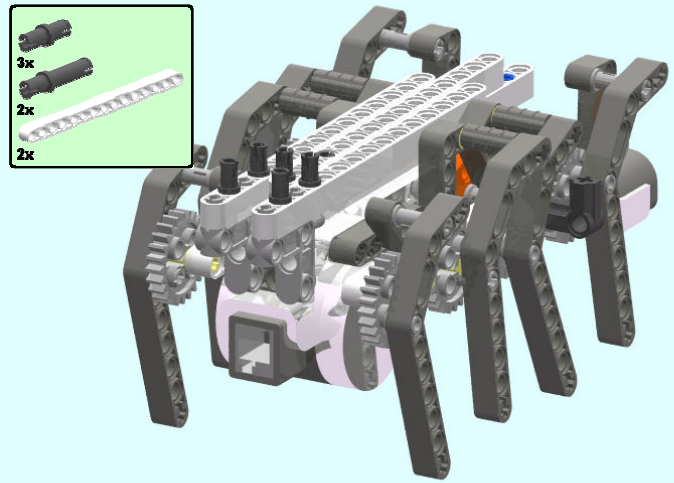

16

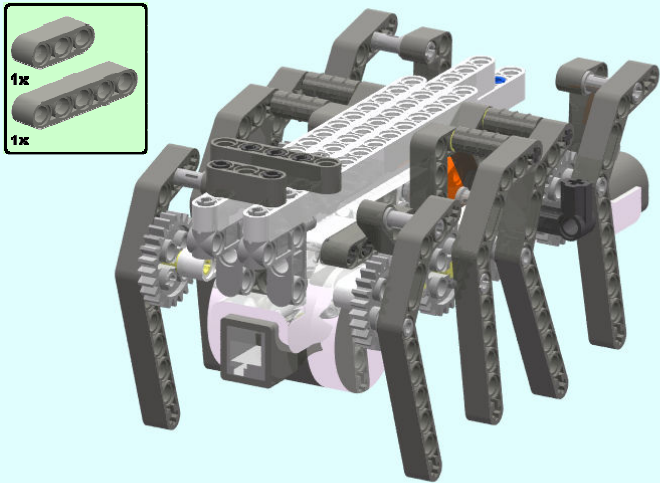

17

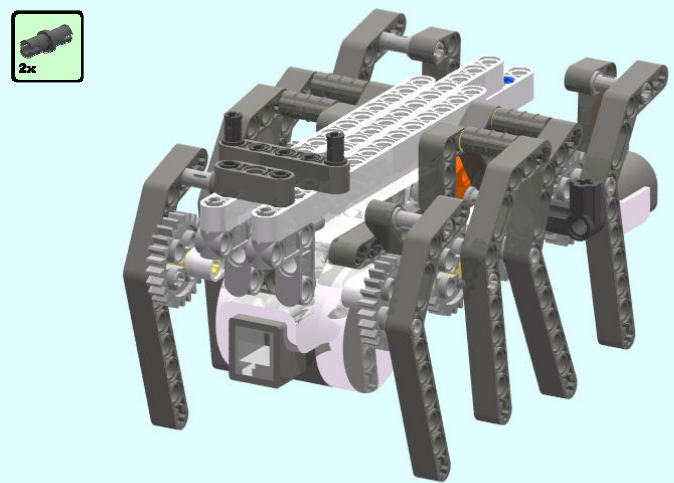

18

Turn around

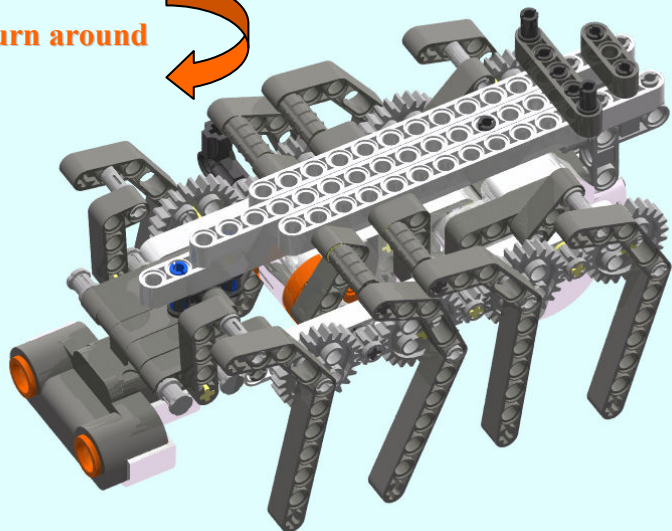

19

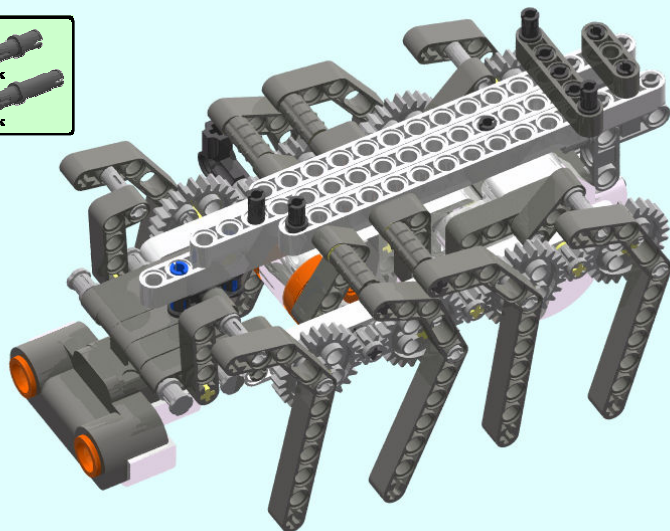

20

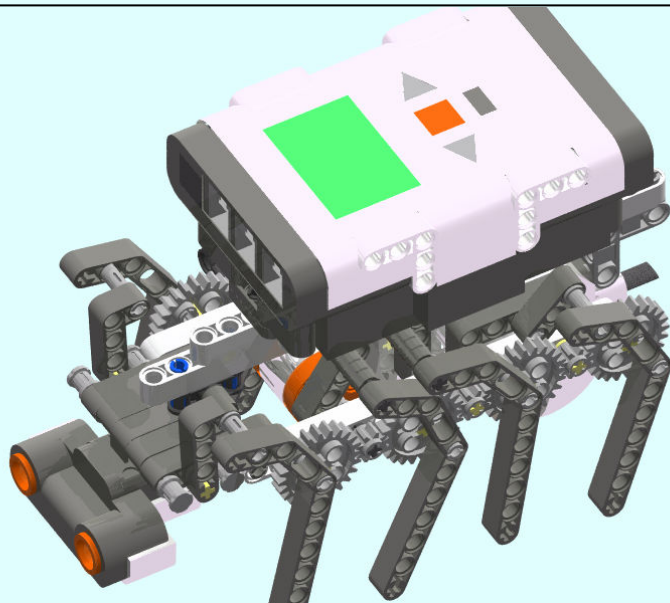
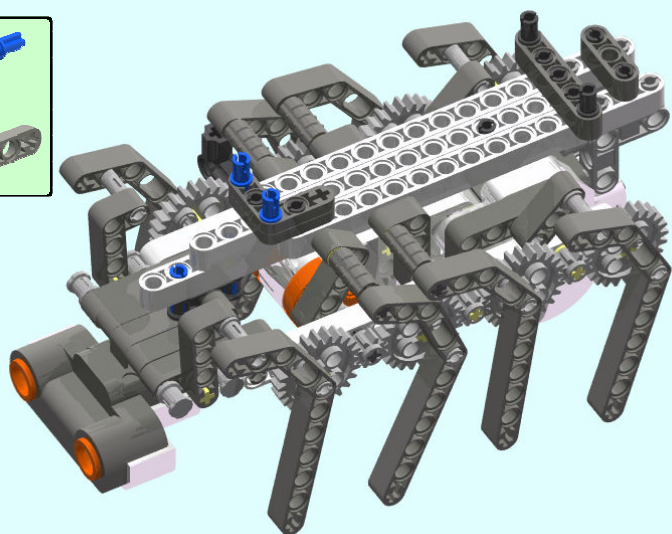
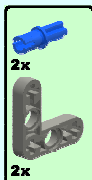

Cabling:

- Motor to "MOTOR A"
- Ultrasonic sensor to "SENSOR 4"

4. Try one of these leg setups

Turn the wheels on both sides in the same position
Follow the pictures bellow when setting the pins

Alternating legs

Right side

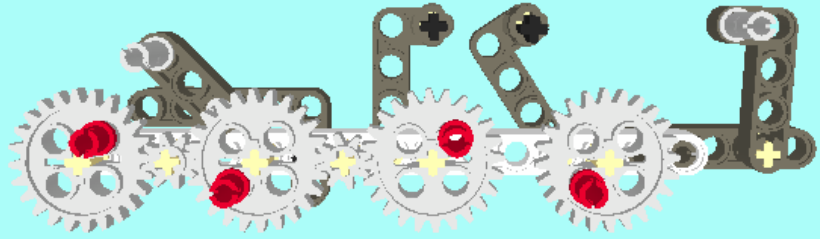

Left Side

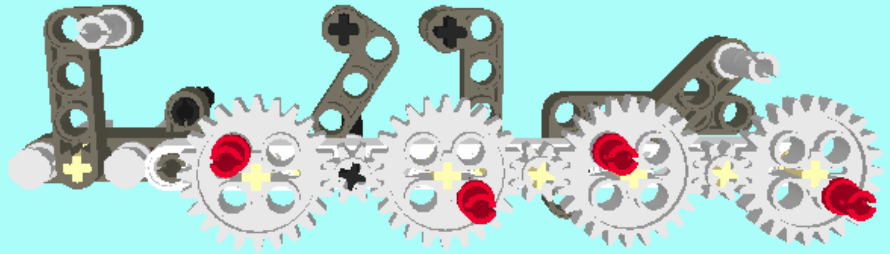

Framing legs

Right side

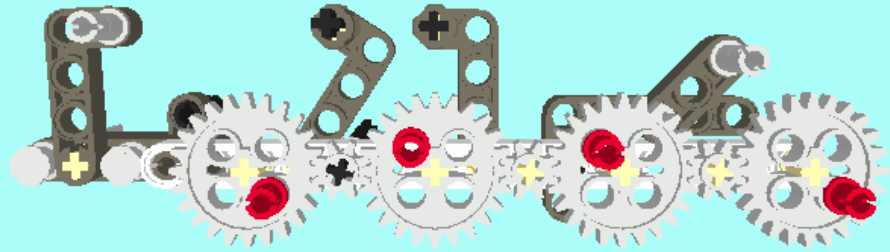

Left Side

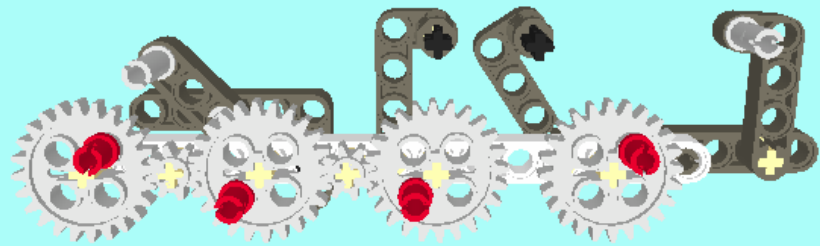

Or find your own solution