

# **Ultimate Collector Series Obi-Wan Kenobi's Actis Eta-2 Jedi Interceptor**

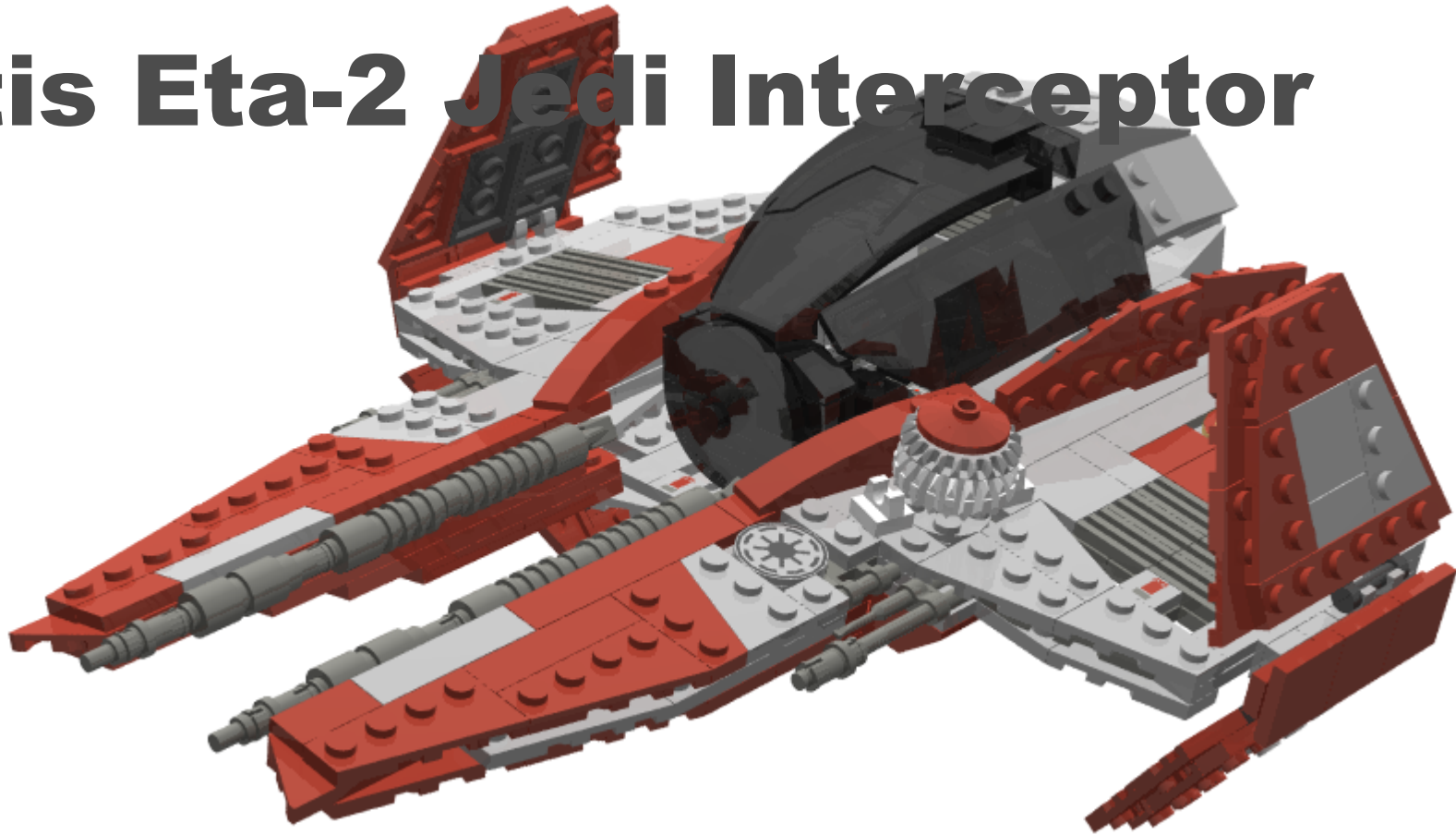

**by Reto Geiger ([bricks@enerprice.ch](mailto:bricks@enerprice.ch))**

1/24<sup>th</sup> Scale UCS Actis Eta-2 Jedi Interceptor  
by Reto Geiger ([bricks@enerprice.ch](mailto:bricks@enerprice.ch))

For a parts list, see separate parts.txt file.

These instructions are meant for personal use only. If you want to use them for commercial purposes (eg. selling on eBay), contact me first to get my consent. I reserve the right not to grant this permission. Thanks for your understanding!

**1**

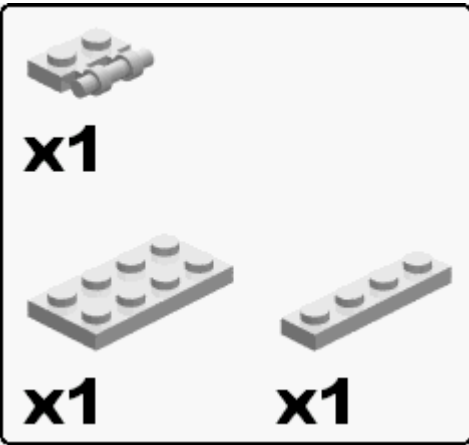

**2**

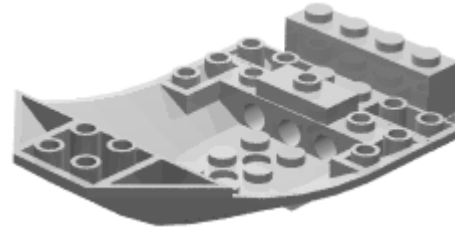
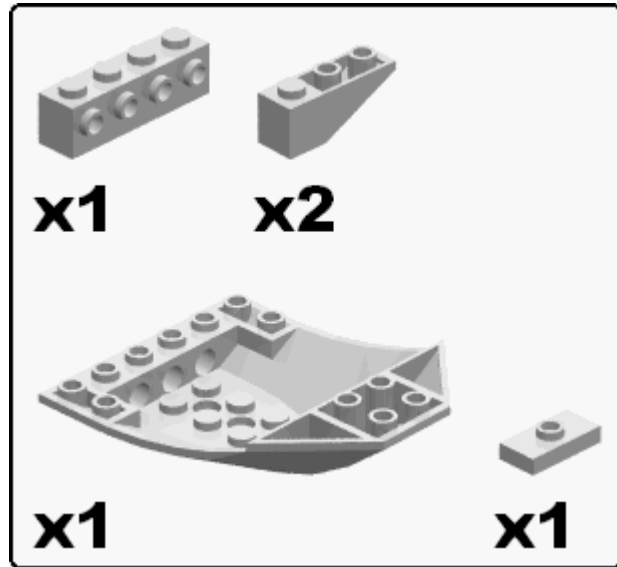

**3**

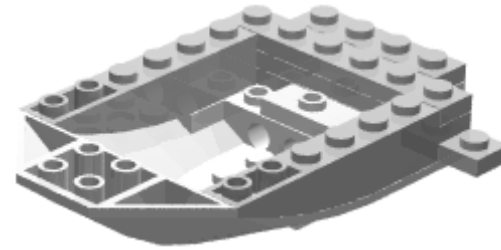
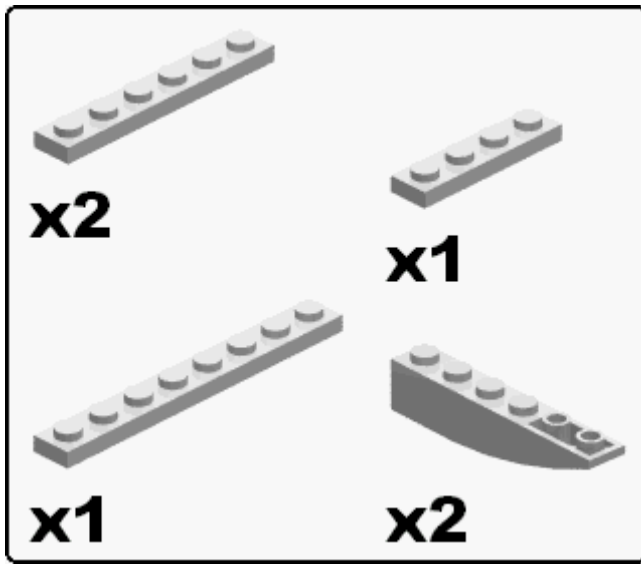

**4**

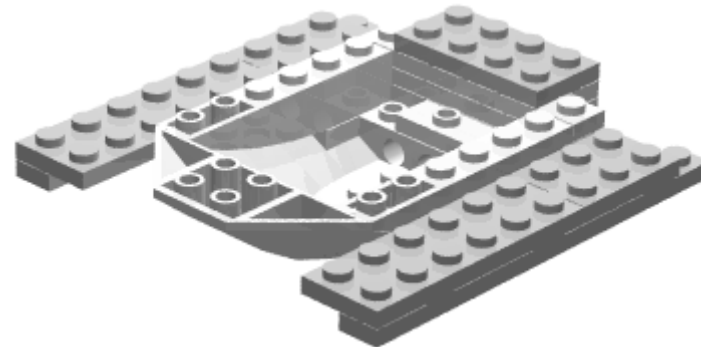
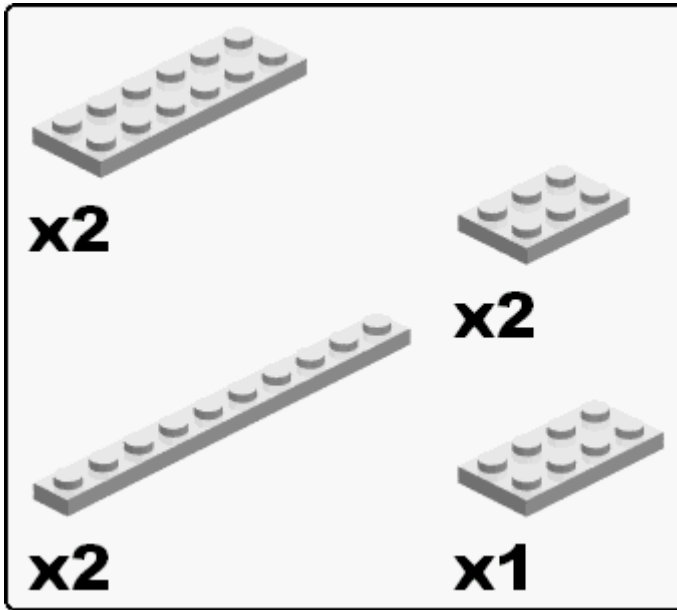



**7**

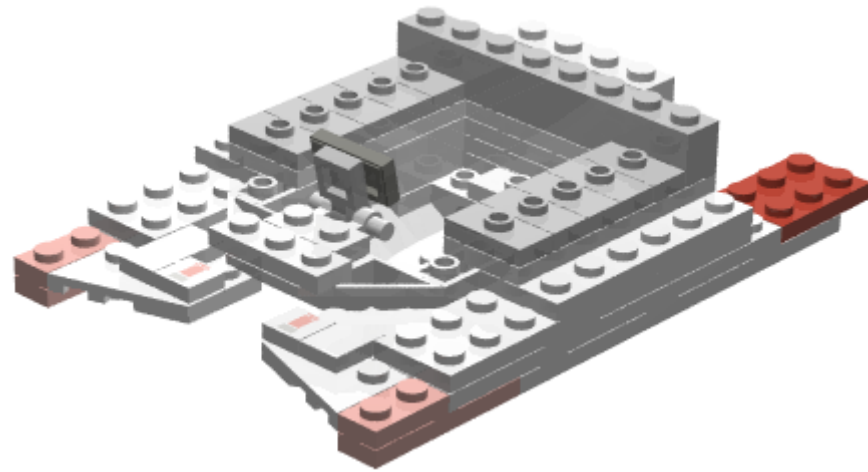
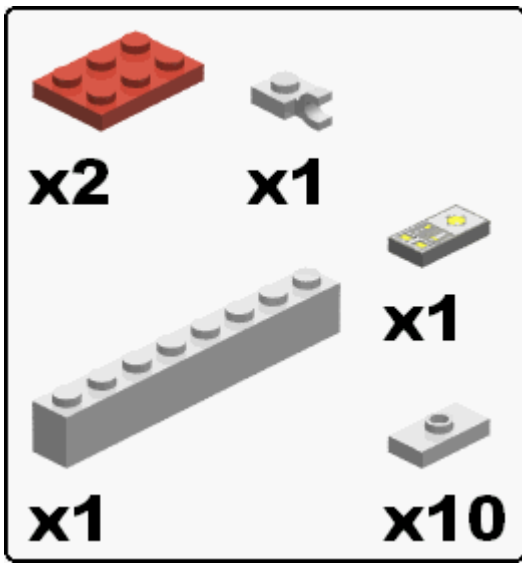

**1**

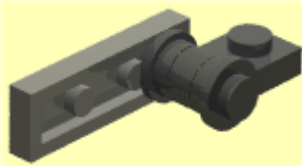
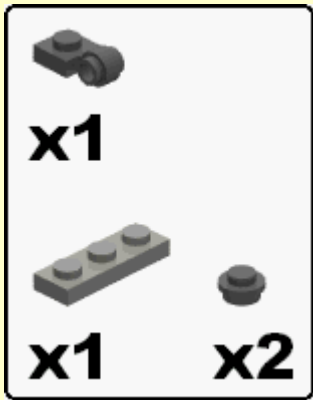

**2**

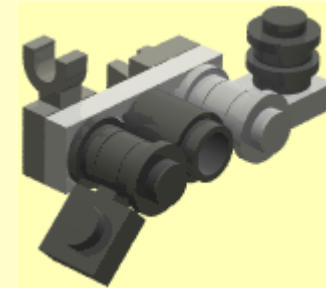
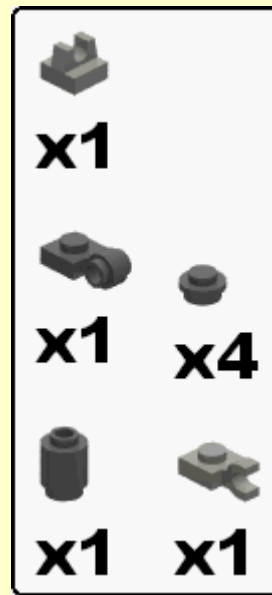

# 3

<b>x1</b>	<b>x2</b>
<b>x1</b>	<b>x1</b>
<b>x1</b>	<b>x1</b>

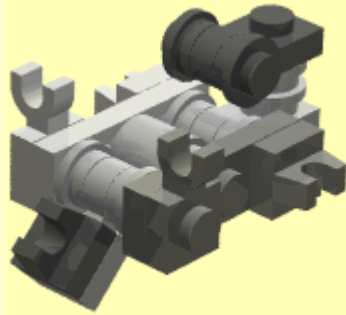

# 4

<b>x1</b>	<b>x2</b>
<b>x1</b>	<b>x1</b>

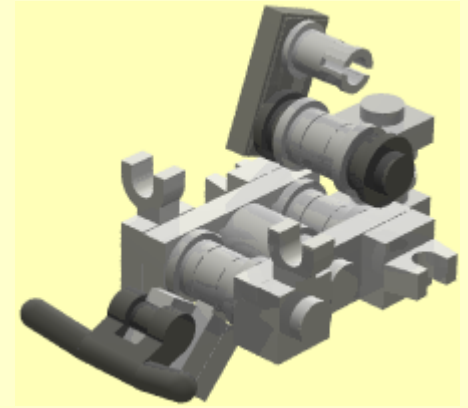

# 5

<b>x1</b>	
<b>x2</b>	<b>x1</b>
<b>x1</b>	<b>x2</b>

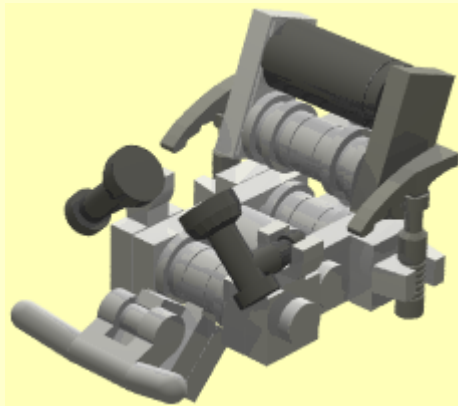

**8**



**x2**



**x4**



**x1**



**x1**



**x2**



**x2**









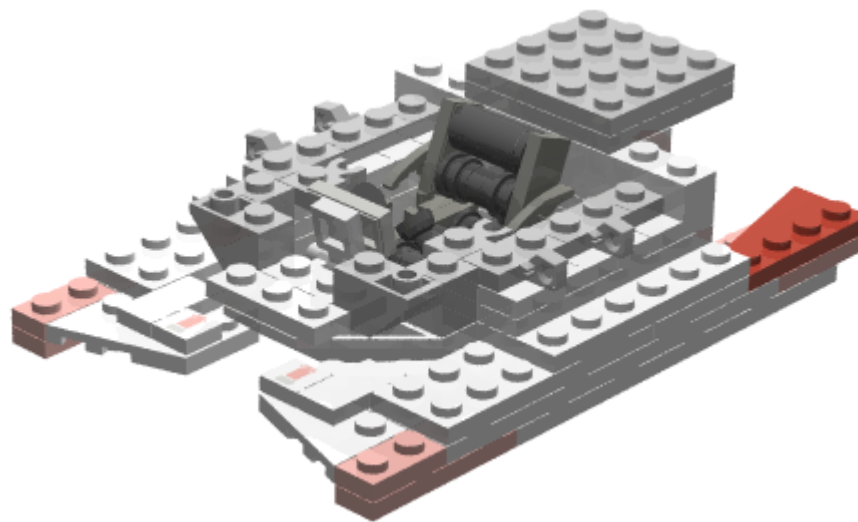



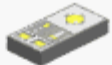

**x2**



**x2**



9



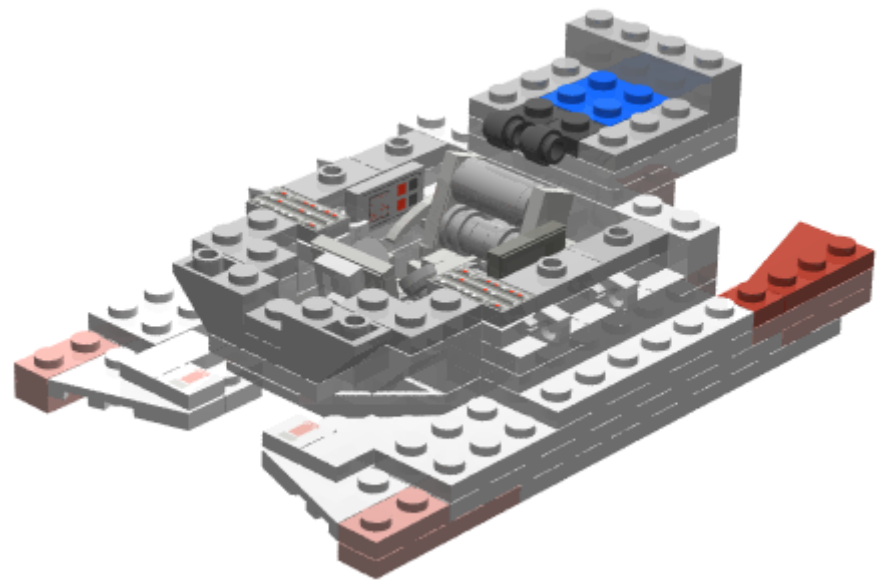

		
x2	x1	x2
		
x1	x4	x2
		
x1	x2	x2
		
x1	x2	x2
		
	x1	x1

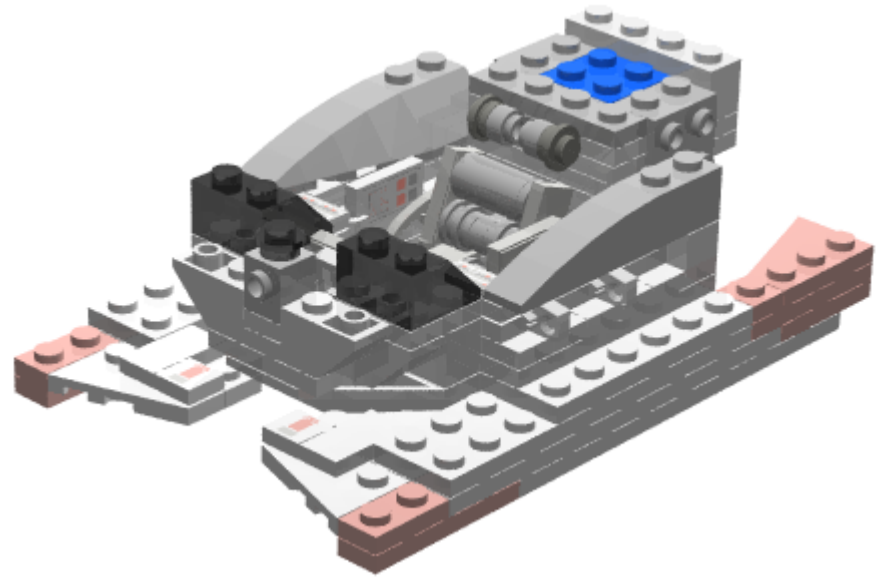
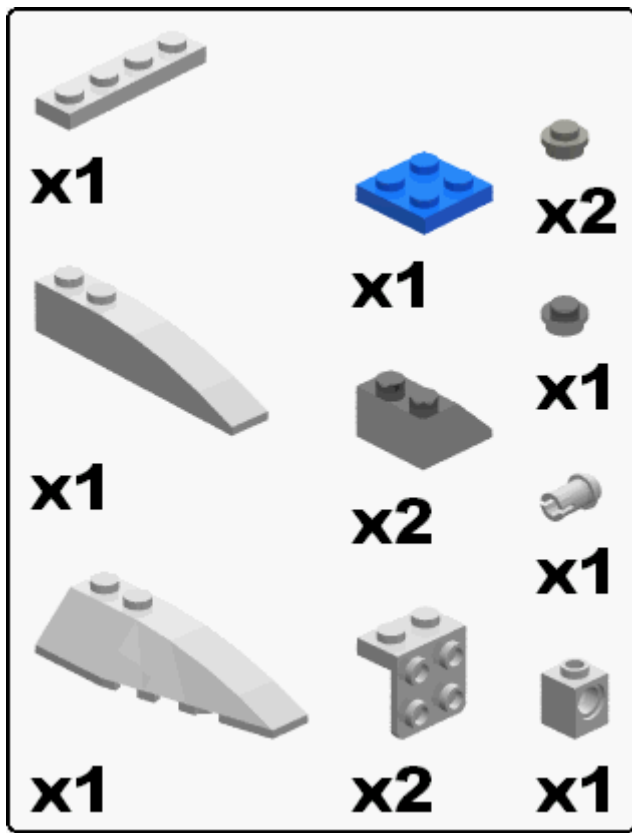

# 10







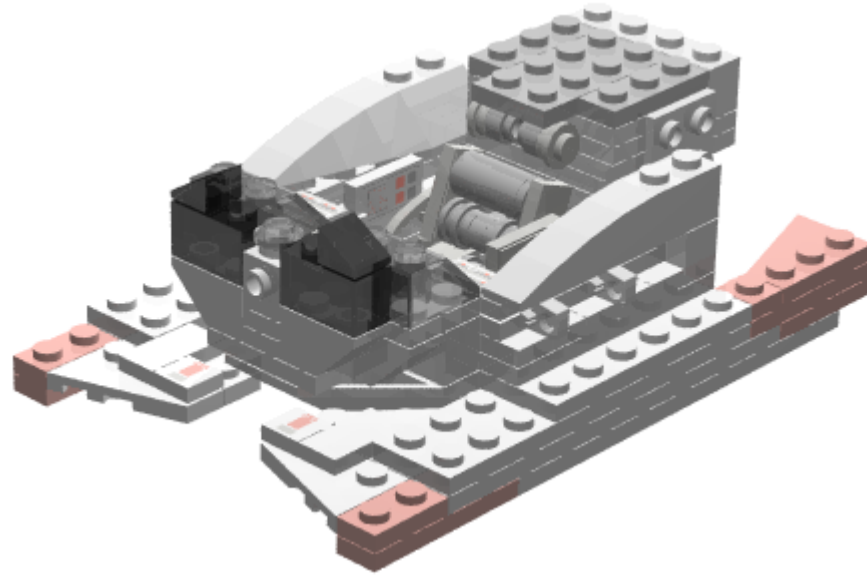

# 11

	
<b>x2</b>	<b>x2</b>
	
<b>x1</b>	<b>x2</b>







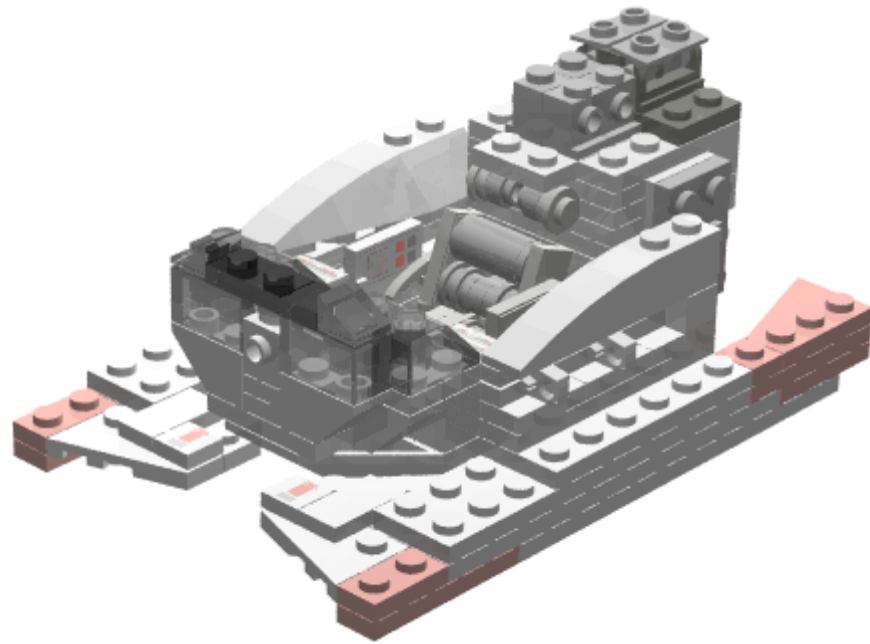

# 12

	<b>x1</b>
<b>x2</b>	
	<b>x4</b>
<b>x2</b>	
	<b>x1</b>
<b>x1</b>	
	<b>x2</b>



# 13



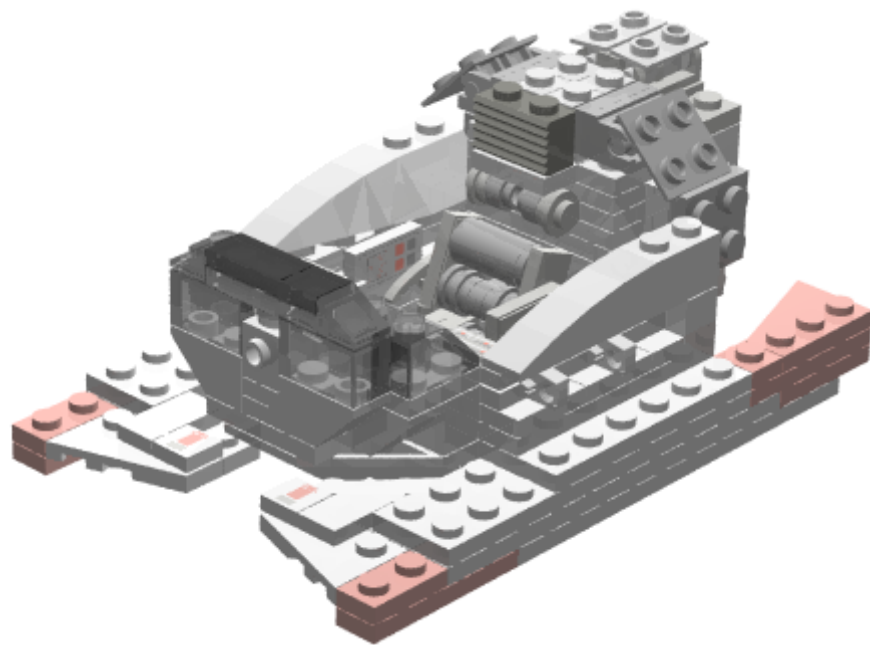

	
<b>x1</b>	
	
<b>x1</b>	<b>x1</b>
	
<b>x2</b>	<b>x2</b>
	
<b>x2</b>	<b>x2</b>

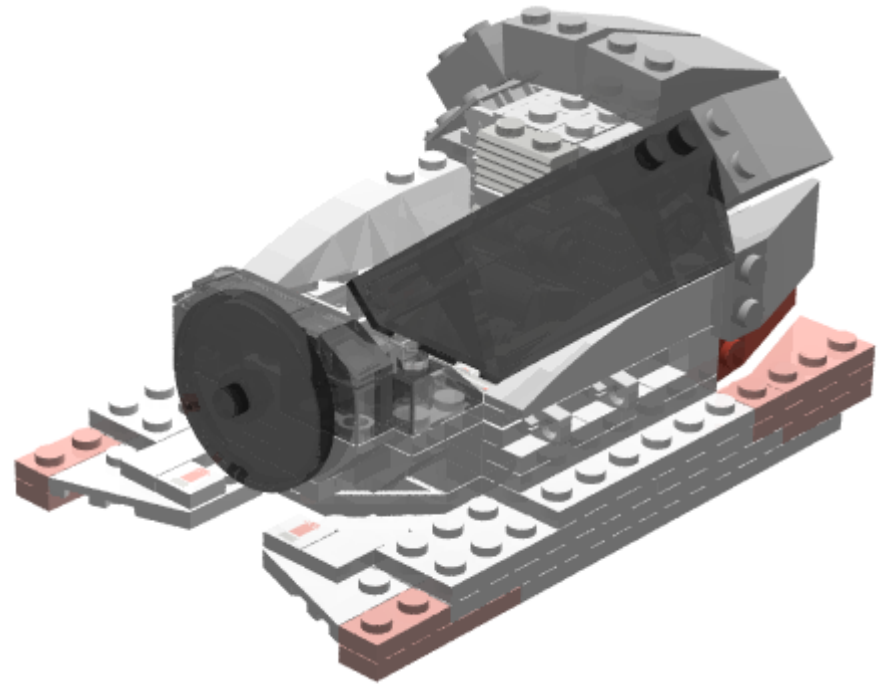
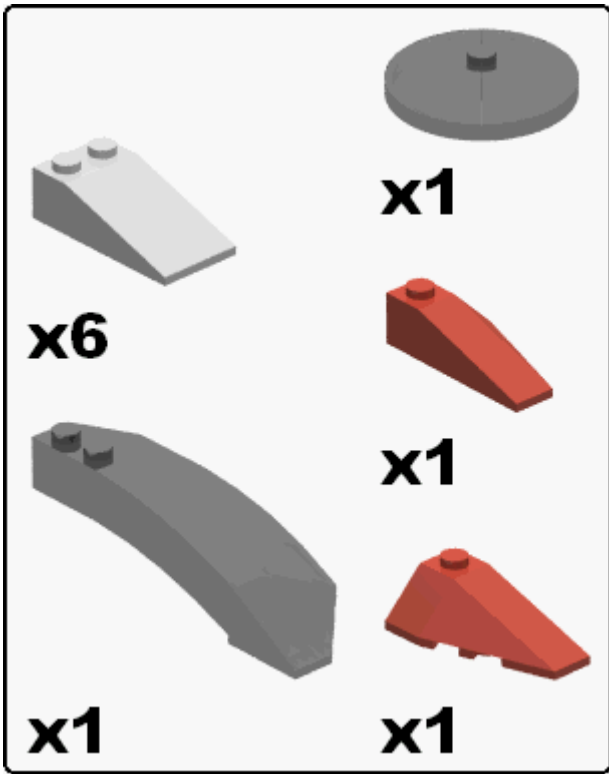

**14**



# 15

	
<b>x2</b>	
	
<b>x2</b>	<b>x2</b>
	
<b>x2</b>	<b>x2</b>

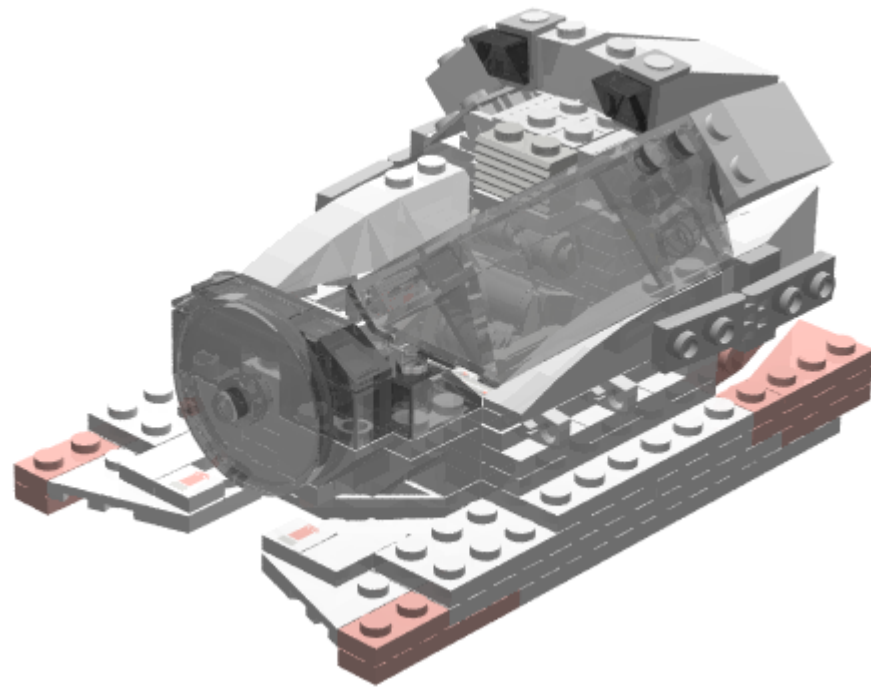

# 16

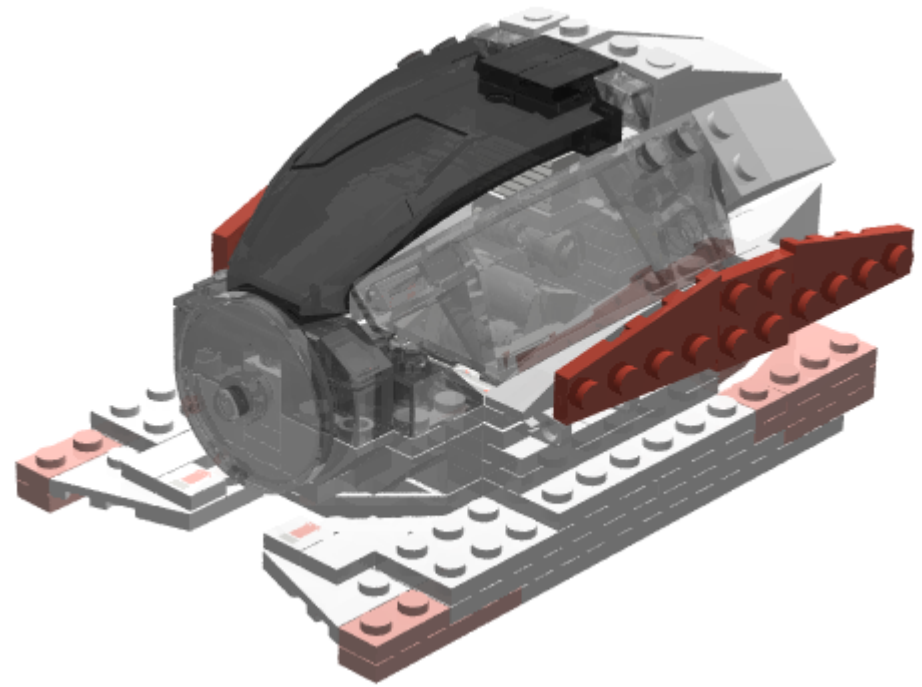
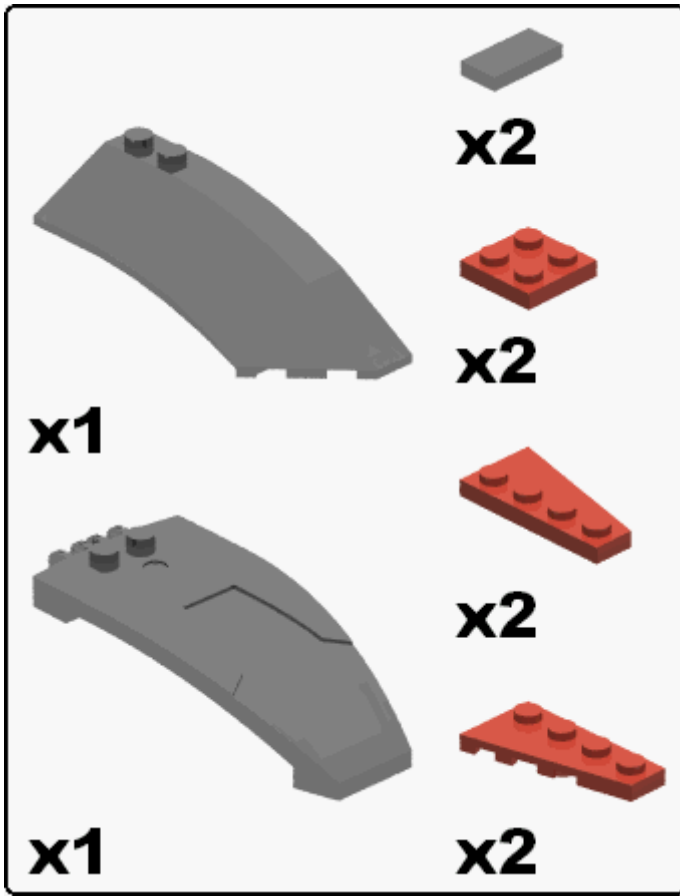



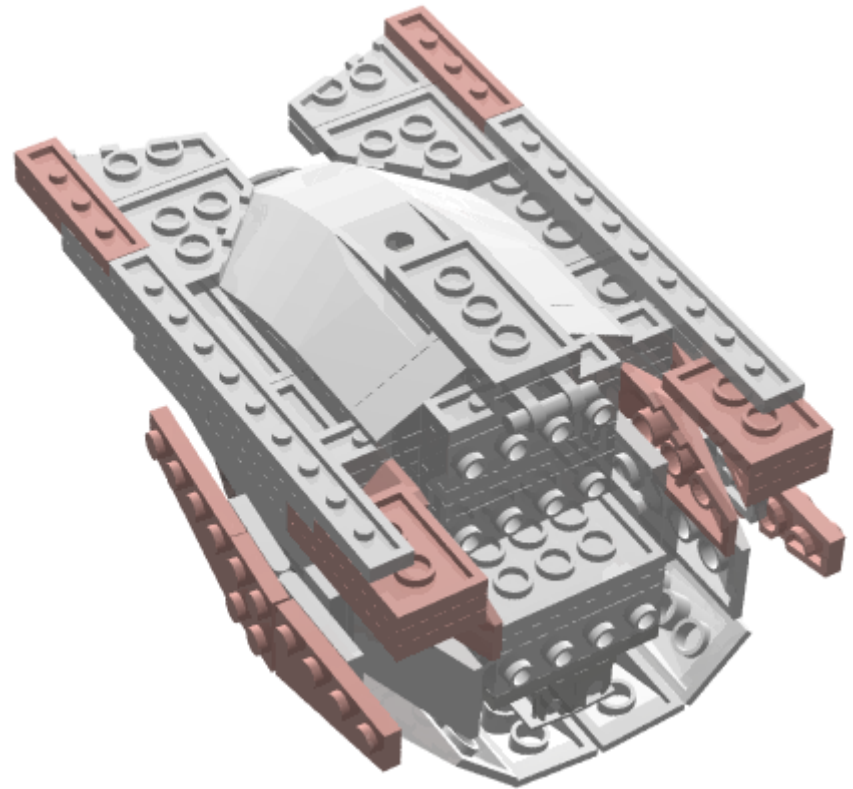



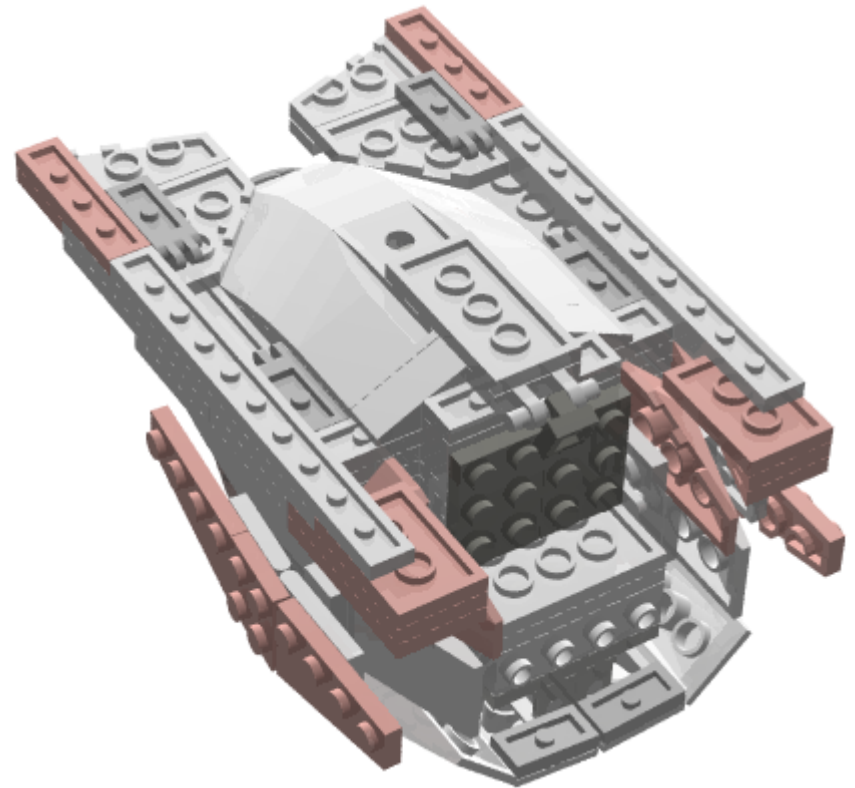
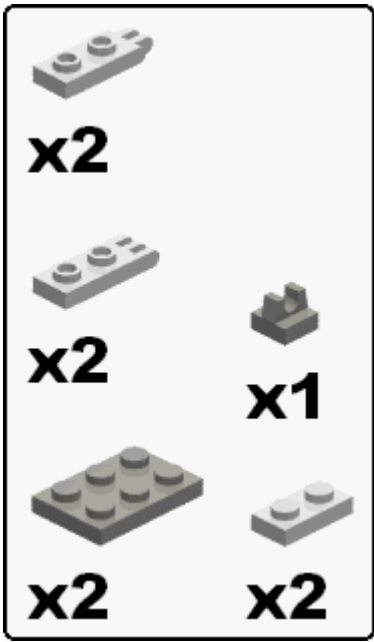

17



**18**







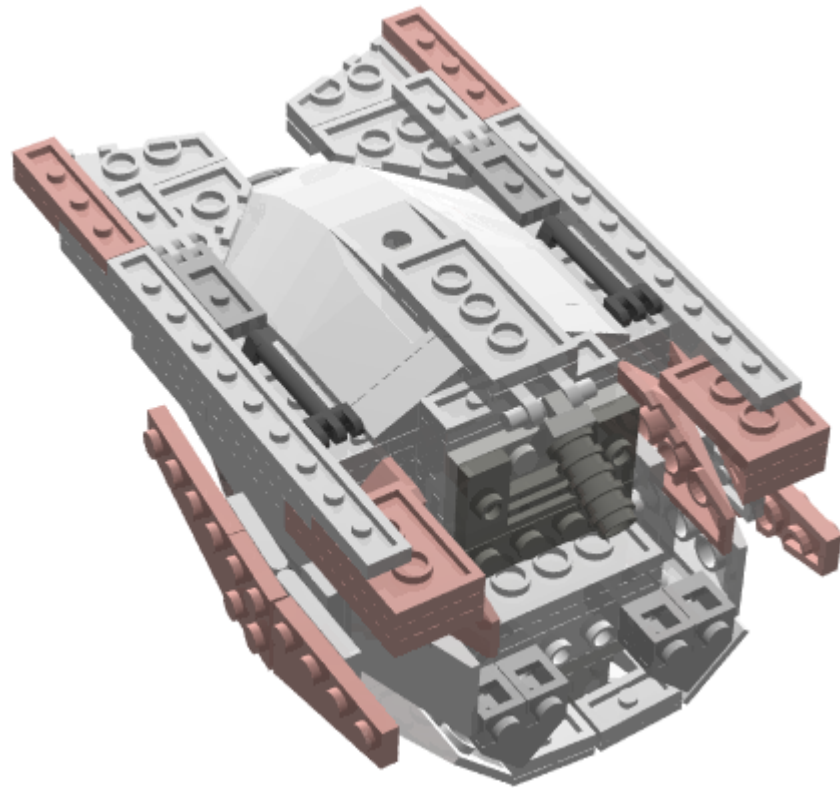

# 19

	
<b>x2</b>	<b>x5</b>
	
<b>x2</b>	<b>x4</b>
	
<b>x2</b>	<b>x1</b>
	
<b>x1</b>	<b>x2</b>





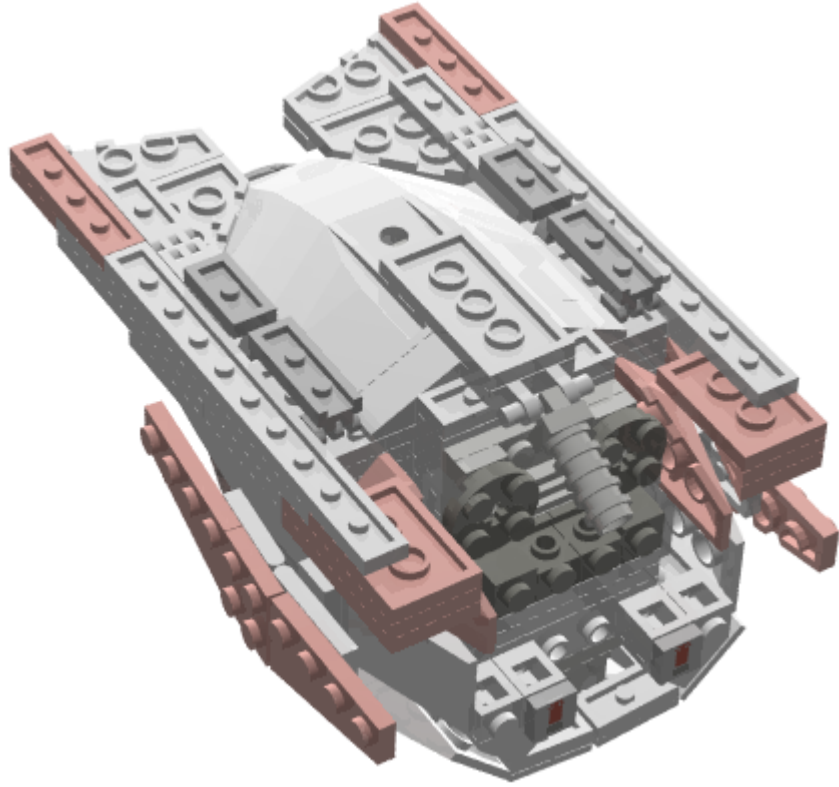

20

	
x2	x2
	
x2	x2
	
x2	x2



# 21

	
<b>x2</b>	
	
<b>x1</b>	<b>x2</b>
	
<b>x1</b>	<b>x4</b>

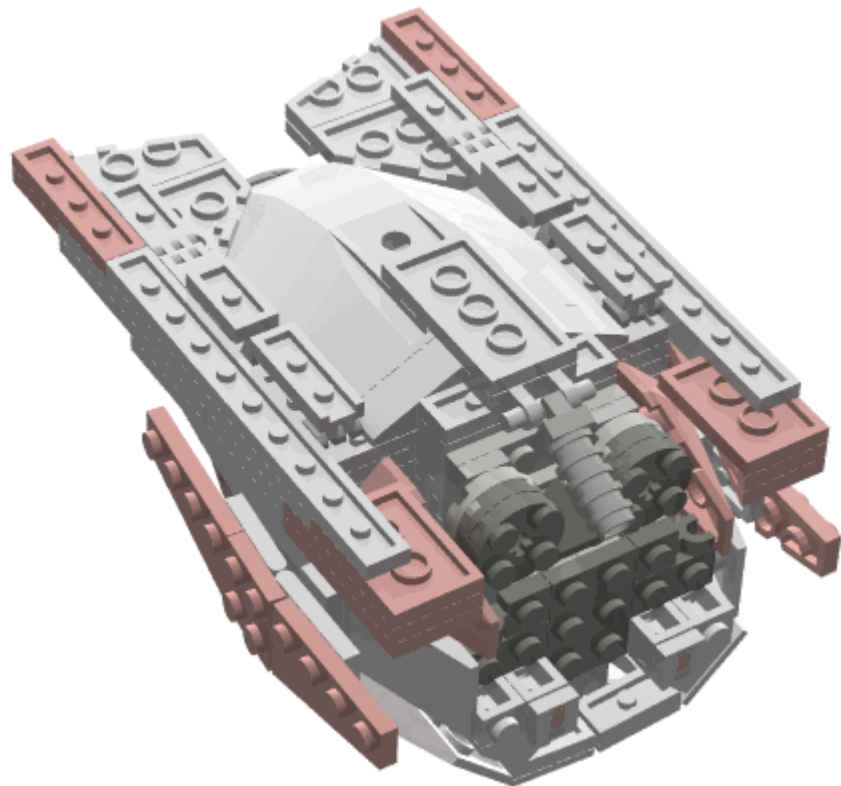

# 22

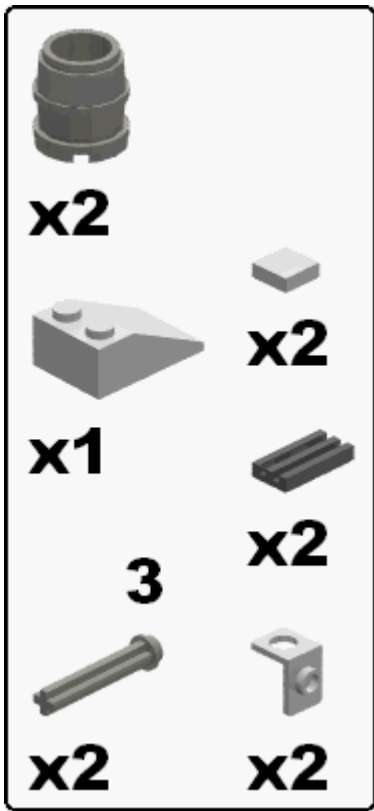

Instructions available for free at:  
<http://www.brickshelf.com/cgi-bin/gallery.cgi?m=rgeiger>

Not for sale

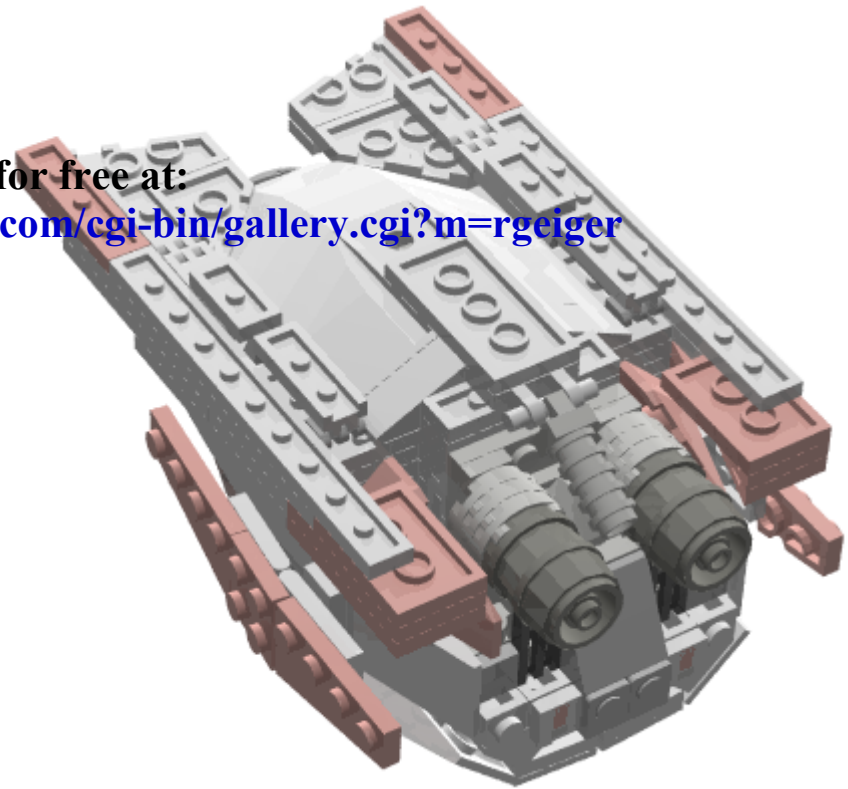

**23**



**x2**



**x1**

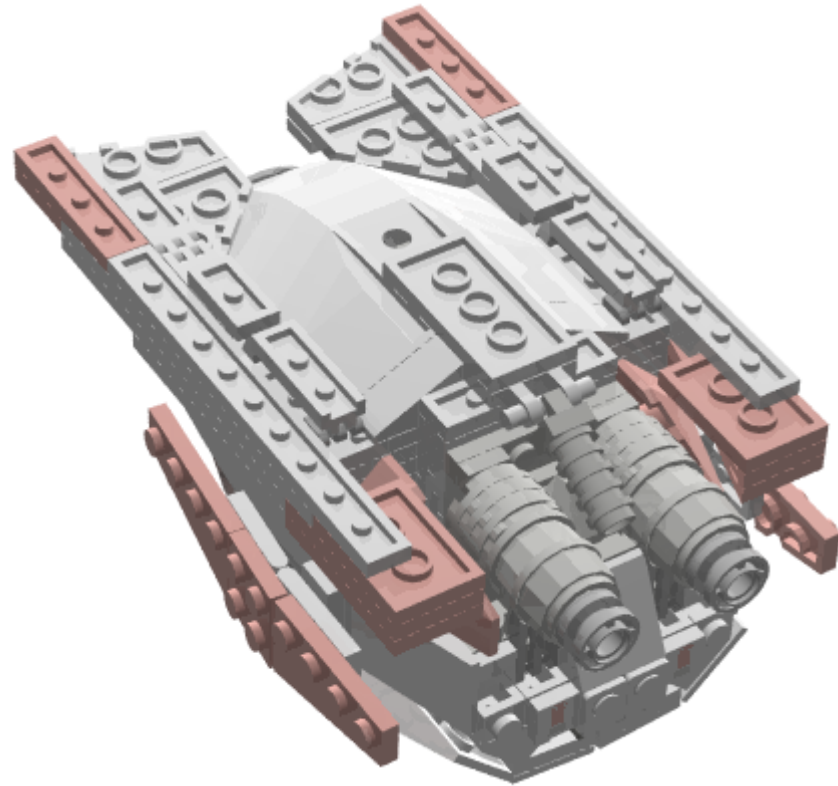

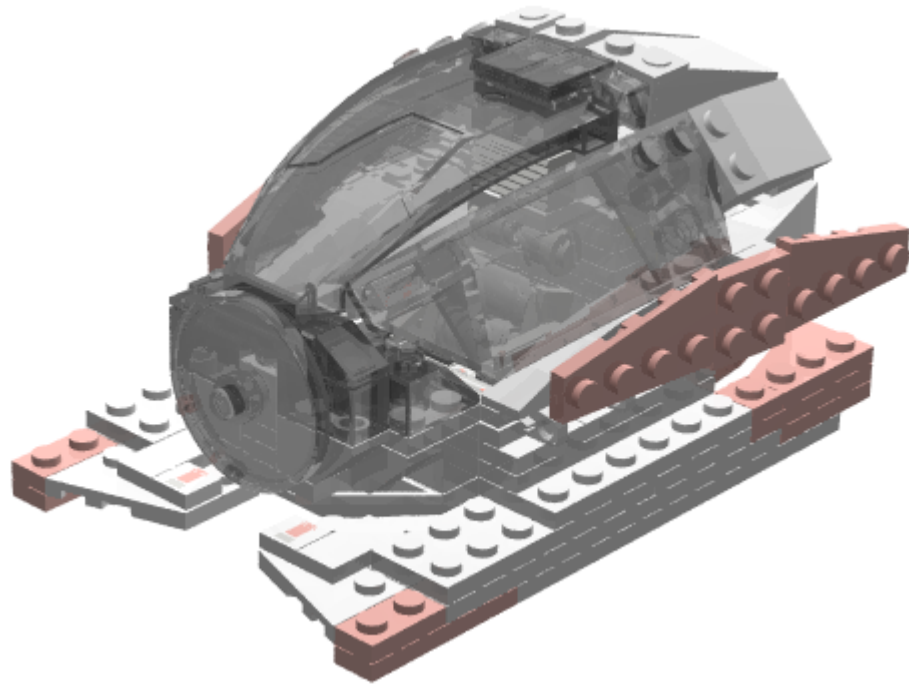

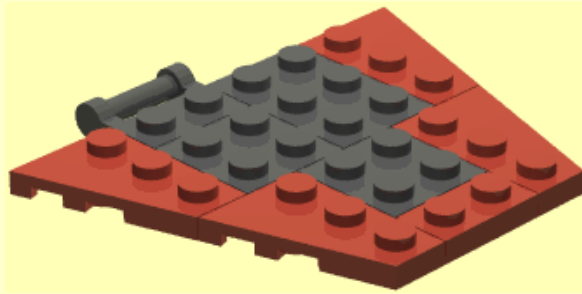
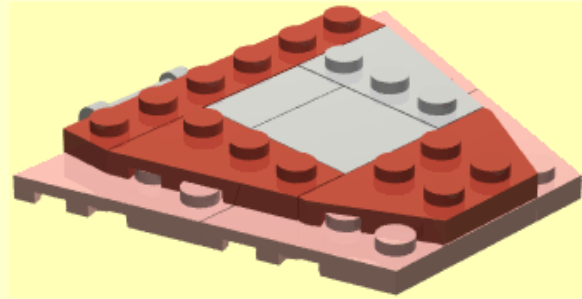
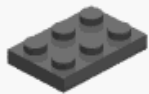
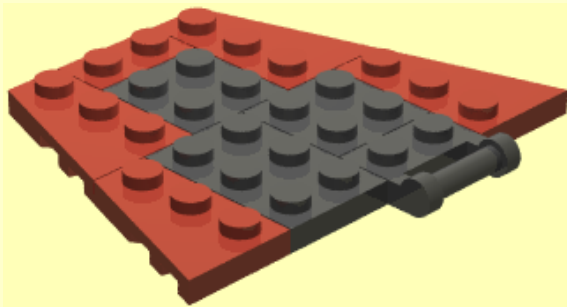
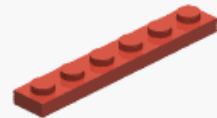
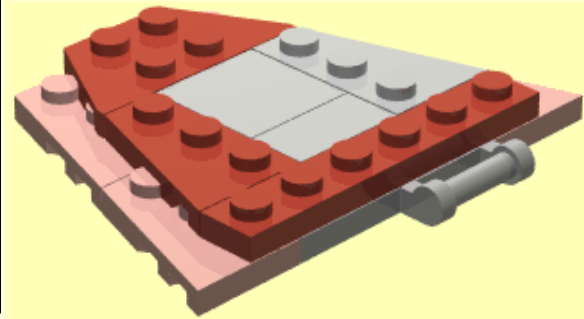

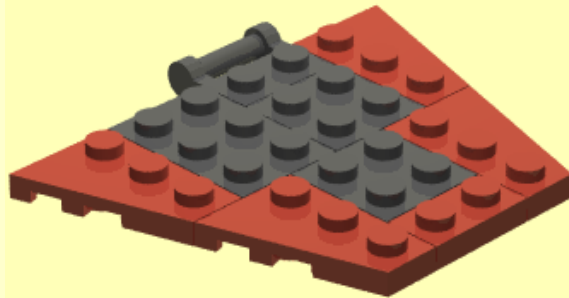
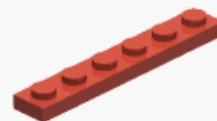
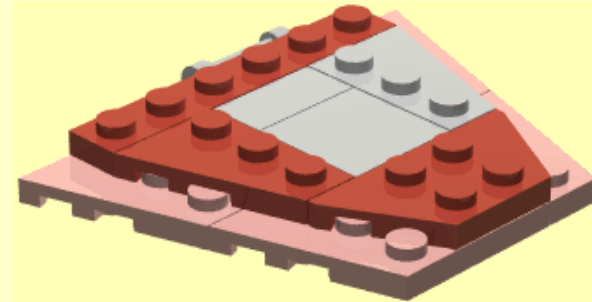
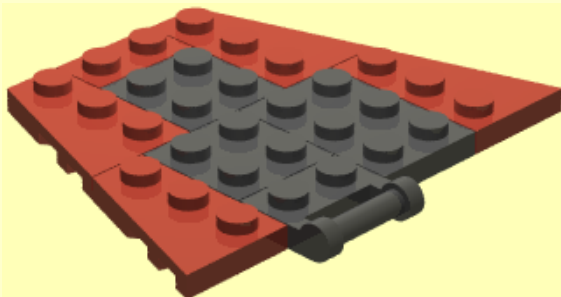
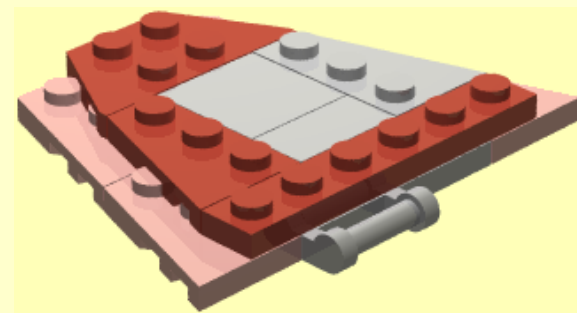











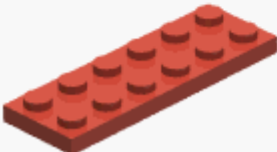

**1****x2****x1****x2****x1****x1****x2****2****x1****x1****x1****x1****x1****x1****1****x2****x1****x2****x1****x1****x2****2****x1****x1****x1****x1****x1****x1**

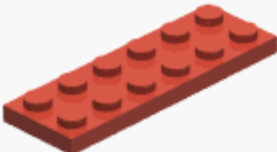





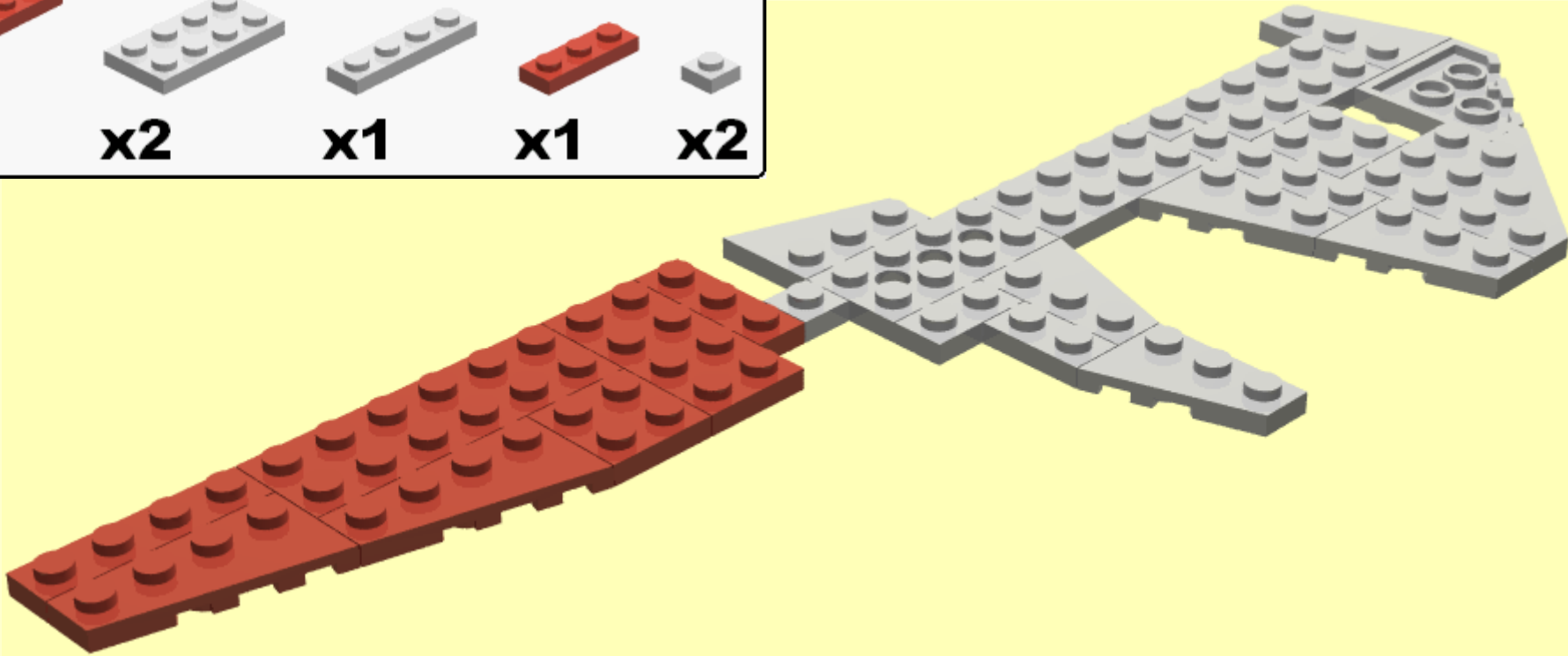





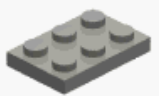













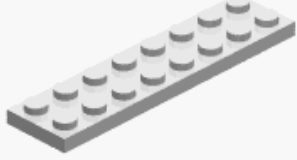

**1****x2****x1****x2****x1****x1****x2****2****x1****x1****x1****x1****x1****x1****1****x2****x1****x2****x1****x1****x2****2****x1****x1****x1****x1****x1****x1**

1

				
<b>x1</b>	<b>x1</b>	<b>x2</b>	<b>x2</b>	
				
<b>x1</b>	<b>x2</b>	<b>x4</b>	<b>x1</b>	
				
<b>x1</b>	<b>x1</b>	<b>x1</b>	<b>x1</b>	
				
<b>x1</b>	<b>x2</b>	<b>x1</b>	<b>x1</b>	<b>x2</b>







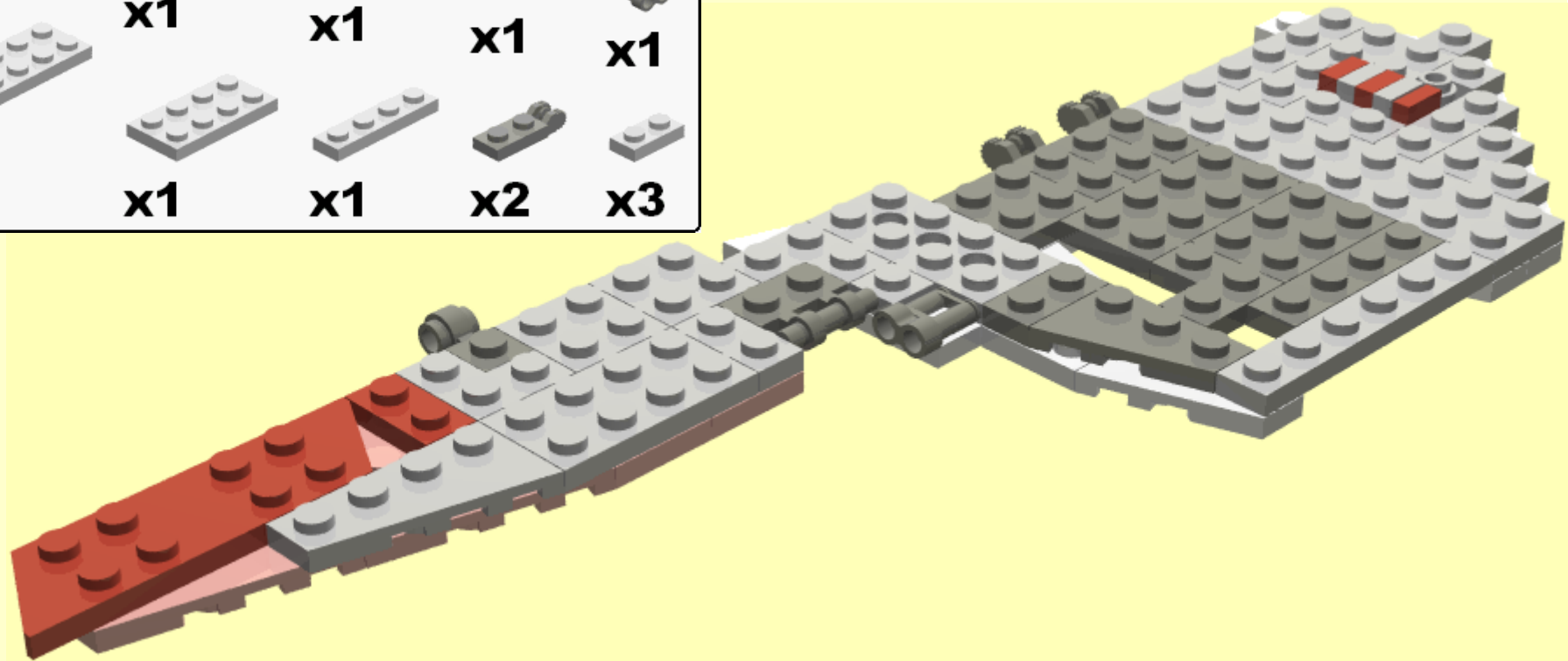























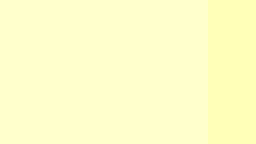

# 2

 x1	 x1	 x1	 x3	 x2	
 x1	 x1	 x1	 x1	 x1	 x1
 x1	 x2	 x1	 x3	 x4	
 x1	 x1	 x1	 x1	 x2	
	 x1	 x1	 x1	 x1	
		 x1	 x2	 x3	





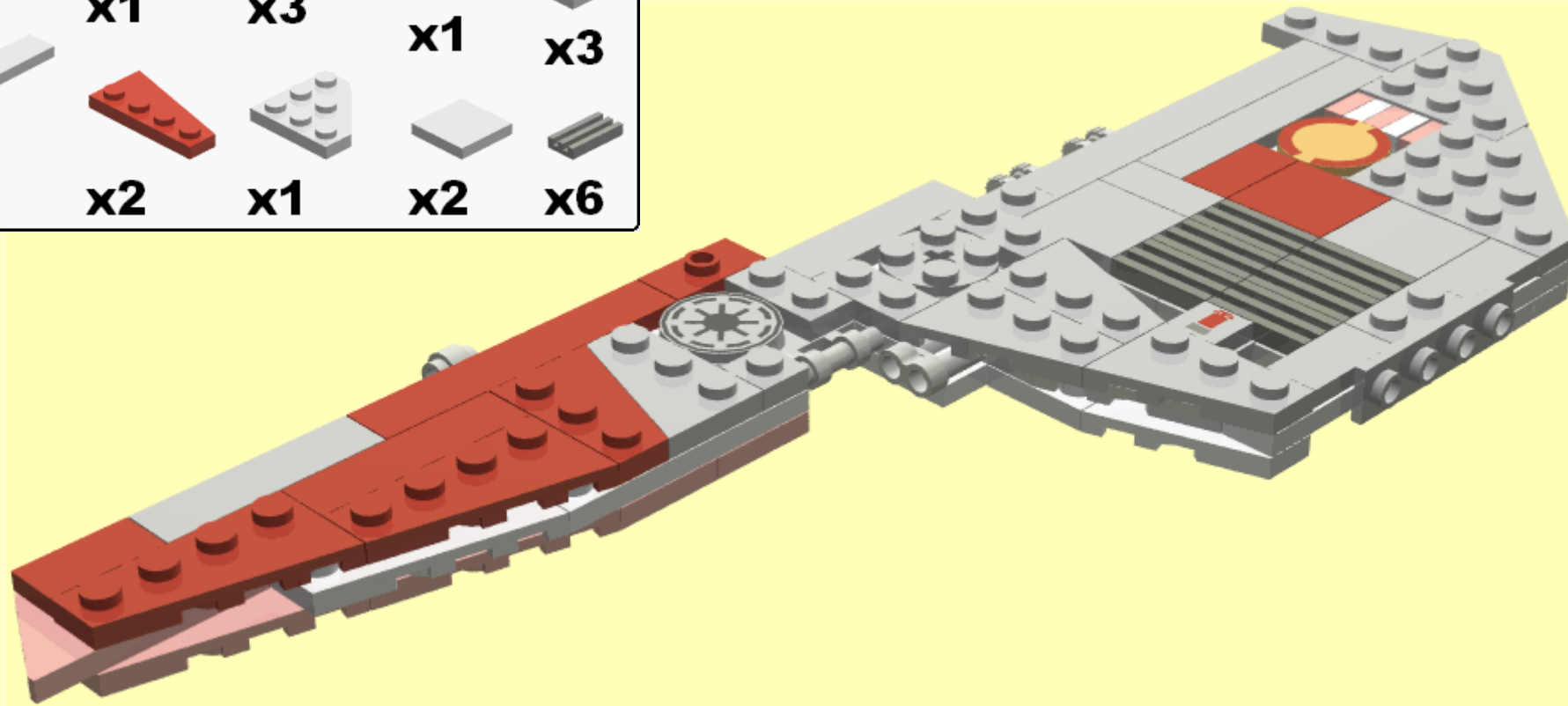

# 3

					
x1	x1	x1	x1	x2	x1
					
x1	x1	x2	x1	x1	x1
					
x1	x2	x1	x2	x1	x1
					
x1	x1	x3	x1	x3	x3
					
x1	x2	x1	x2	x2	x6







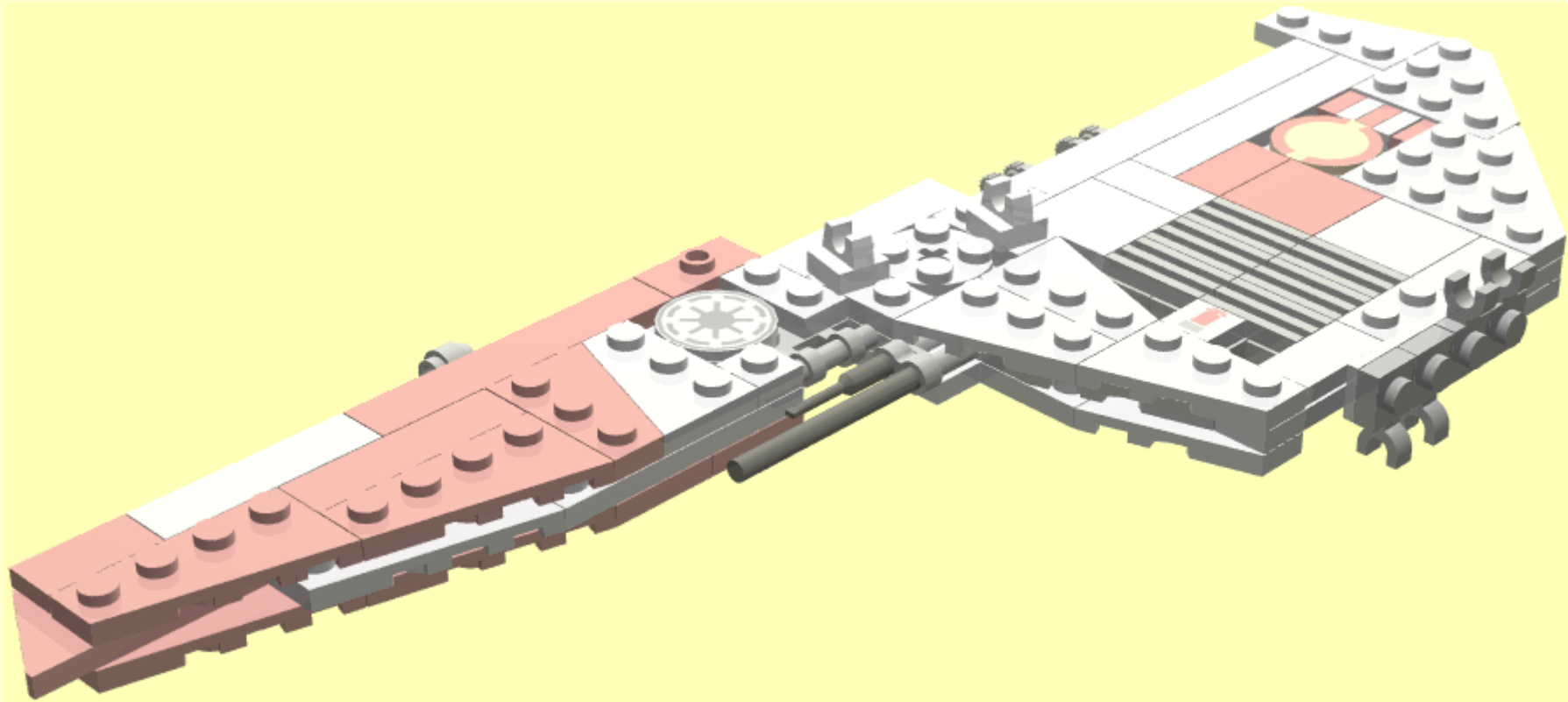

4

	
<b>x1</b>	
	<b>x2</b>
<b>x1</b>	
<b>x1</b>	<b>x4</b>

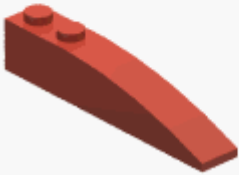

**5**

	<b>x1</b>		<b>x1</b>
	<b>3</b>		<b>x3</b>
	<b>x1</b>		<b>x1</b>

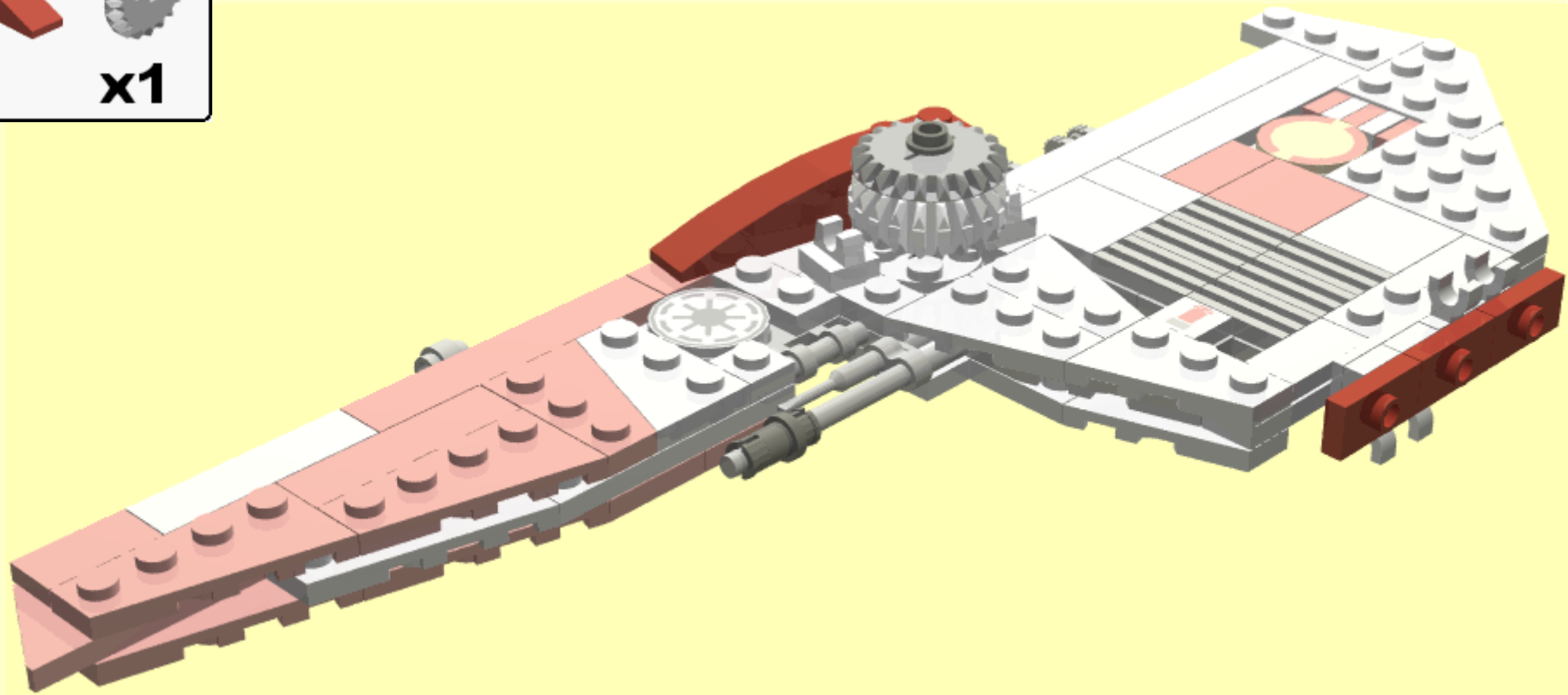

**6**



**x1**



**x3**

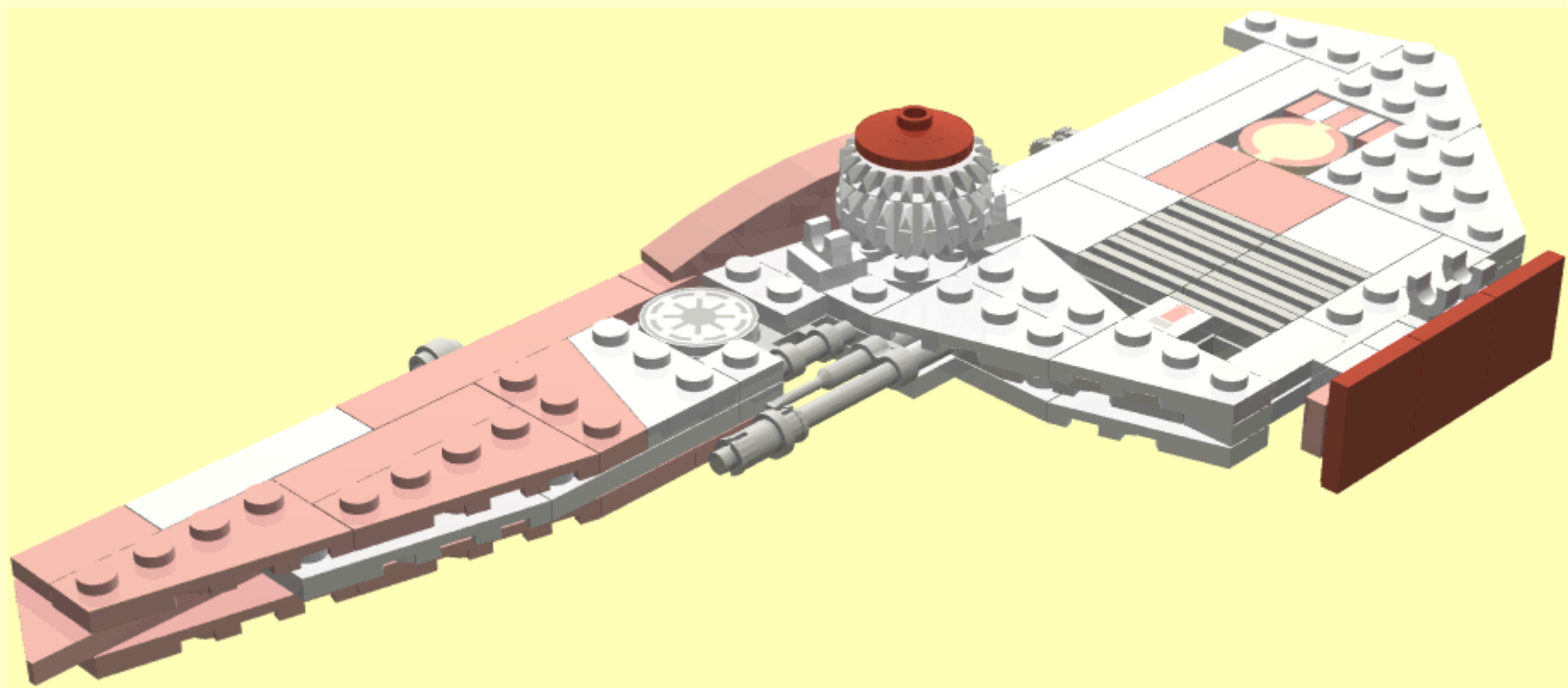

7

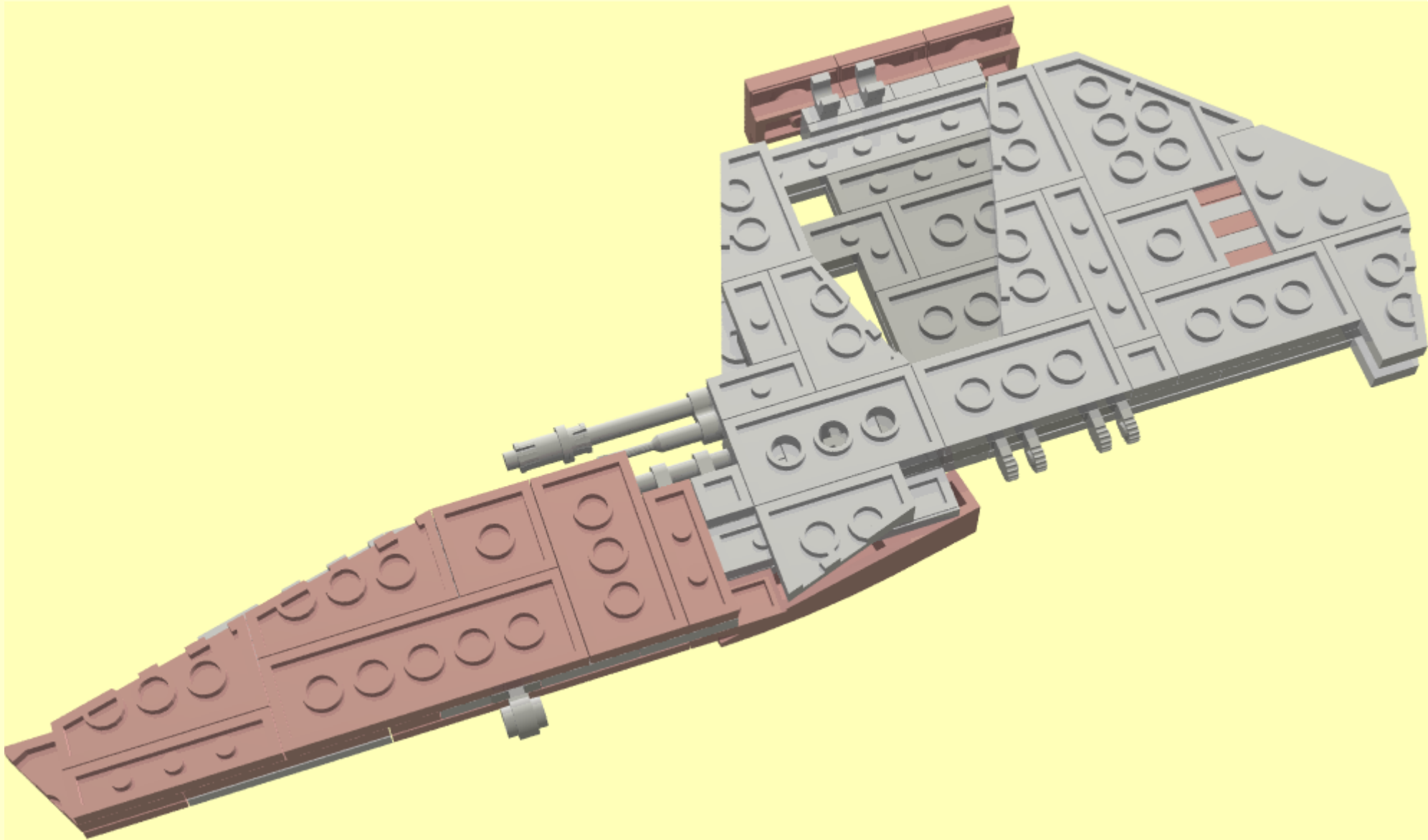

8



x1 x10



x1 x1



x1

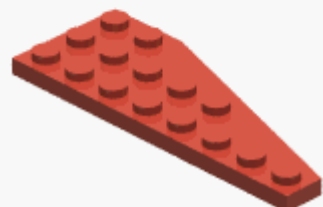



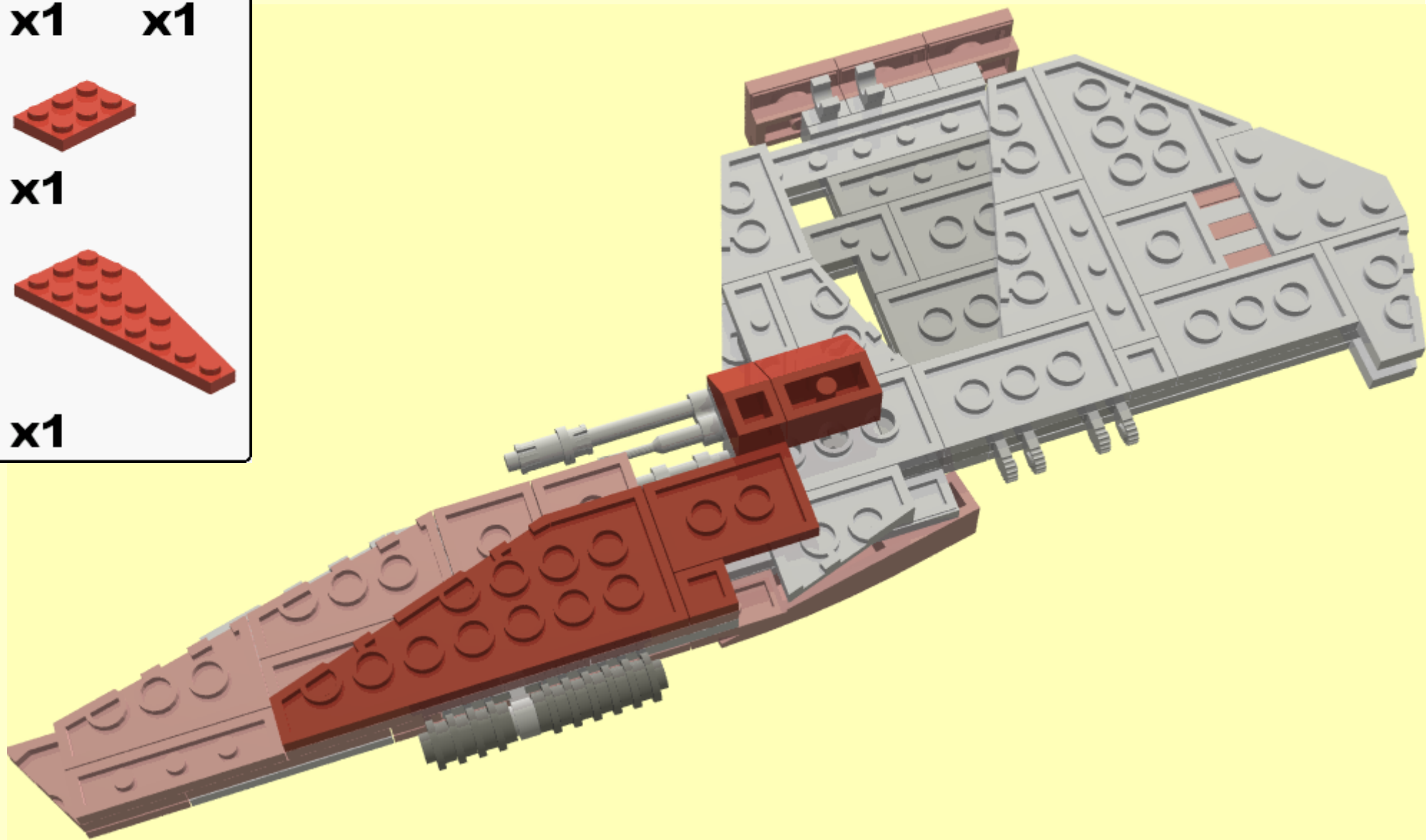

x1

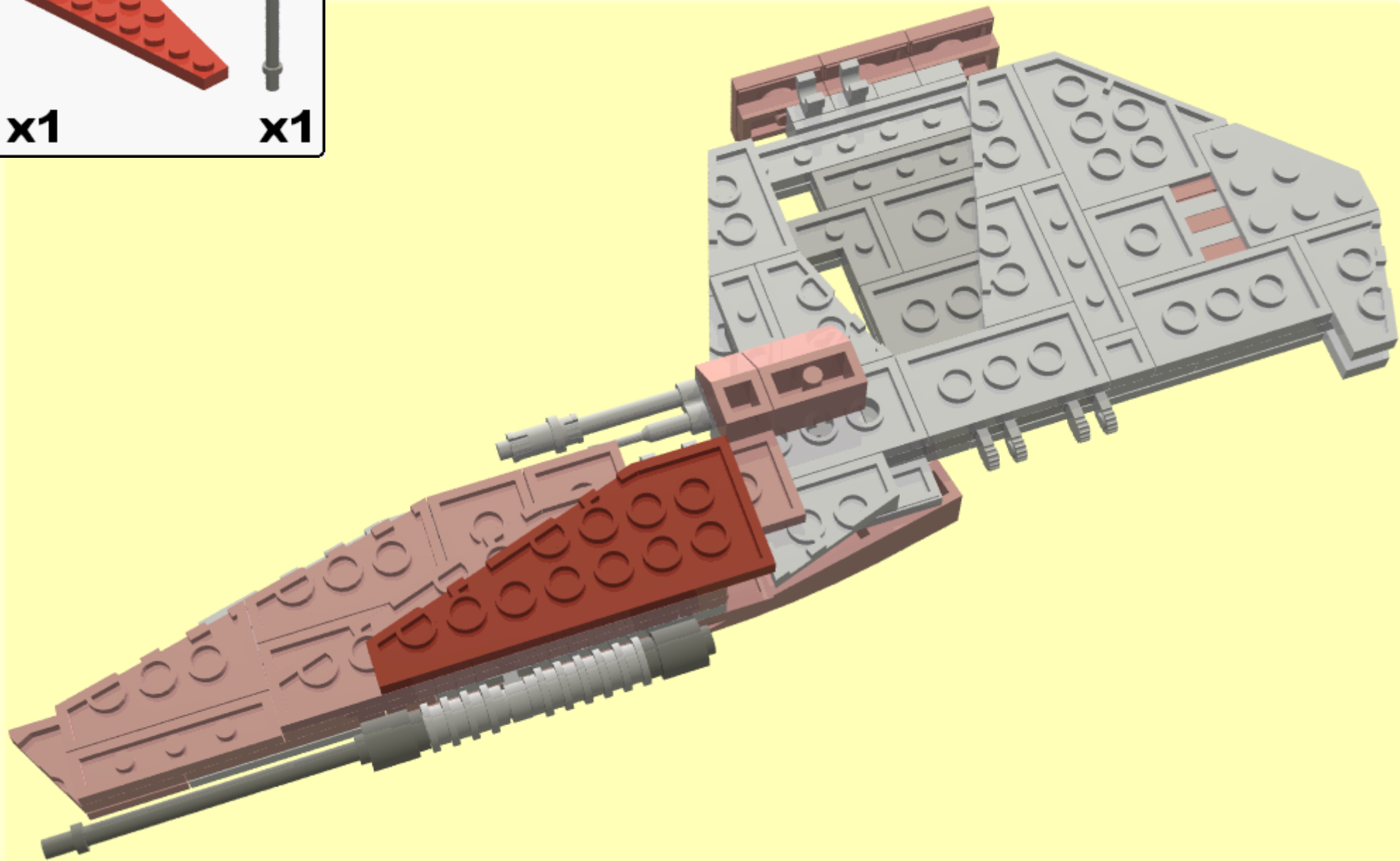
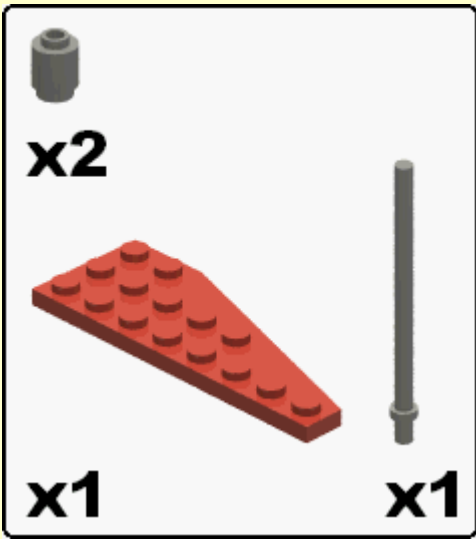

9



**10**



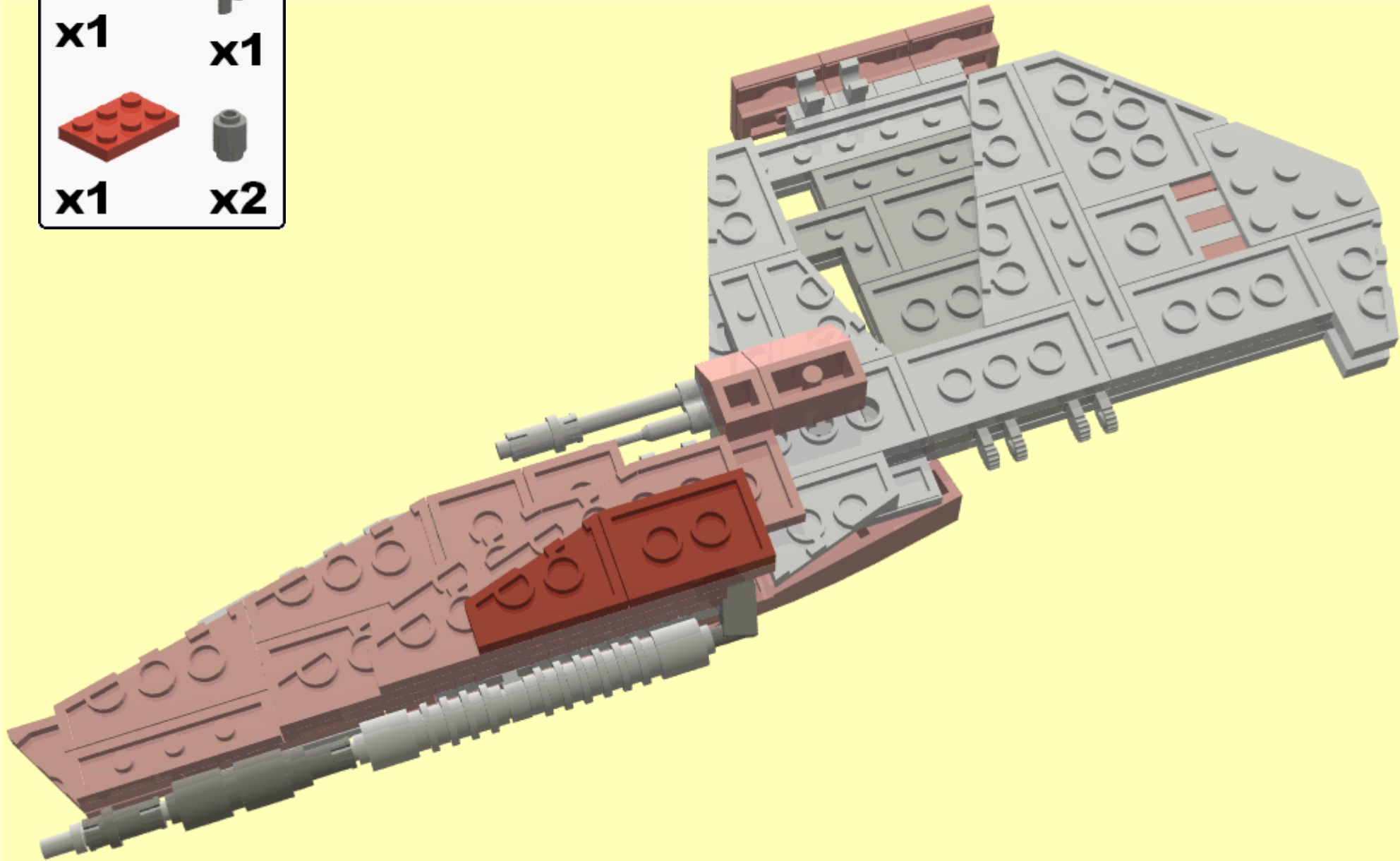



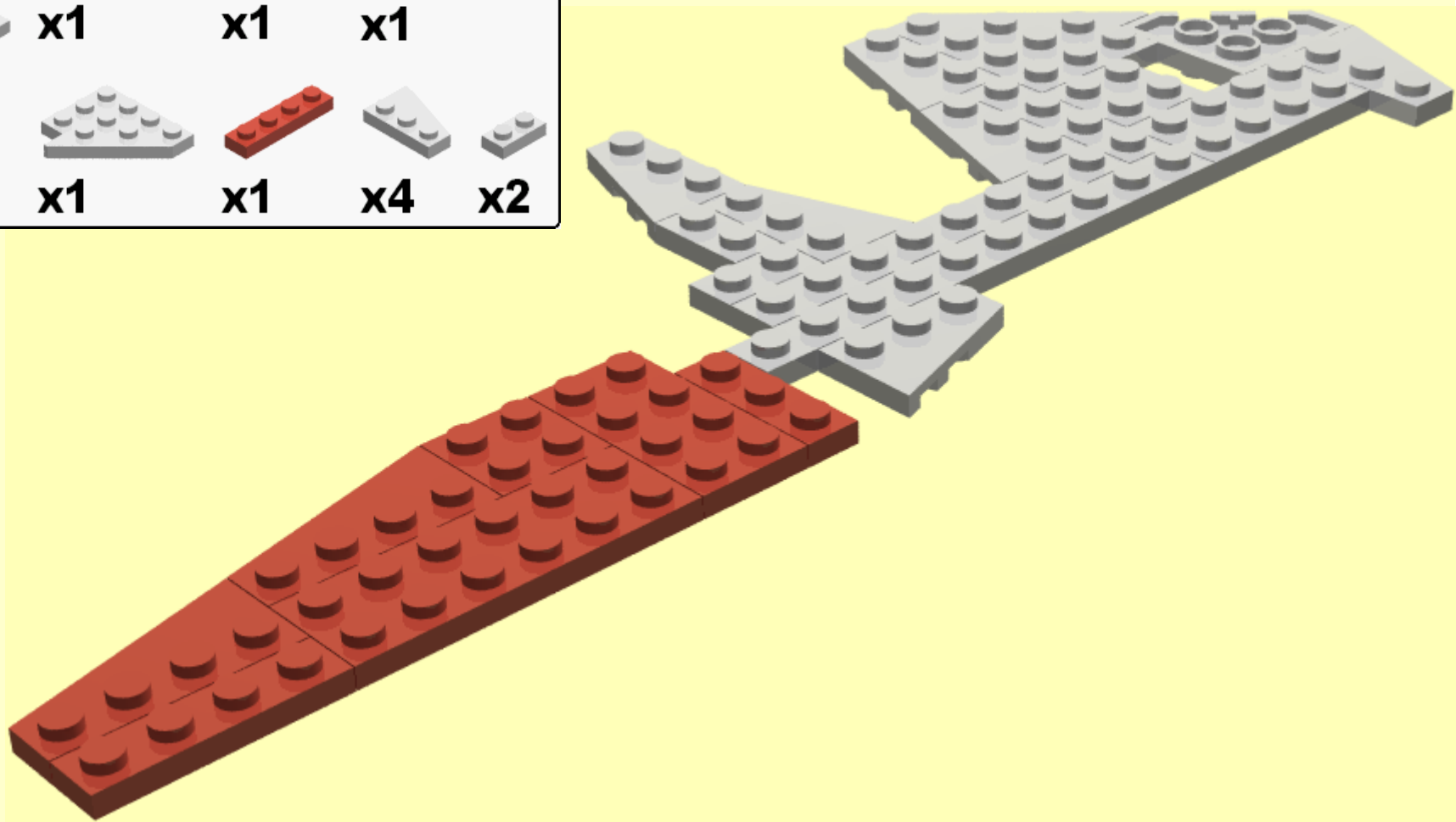
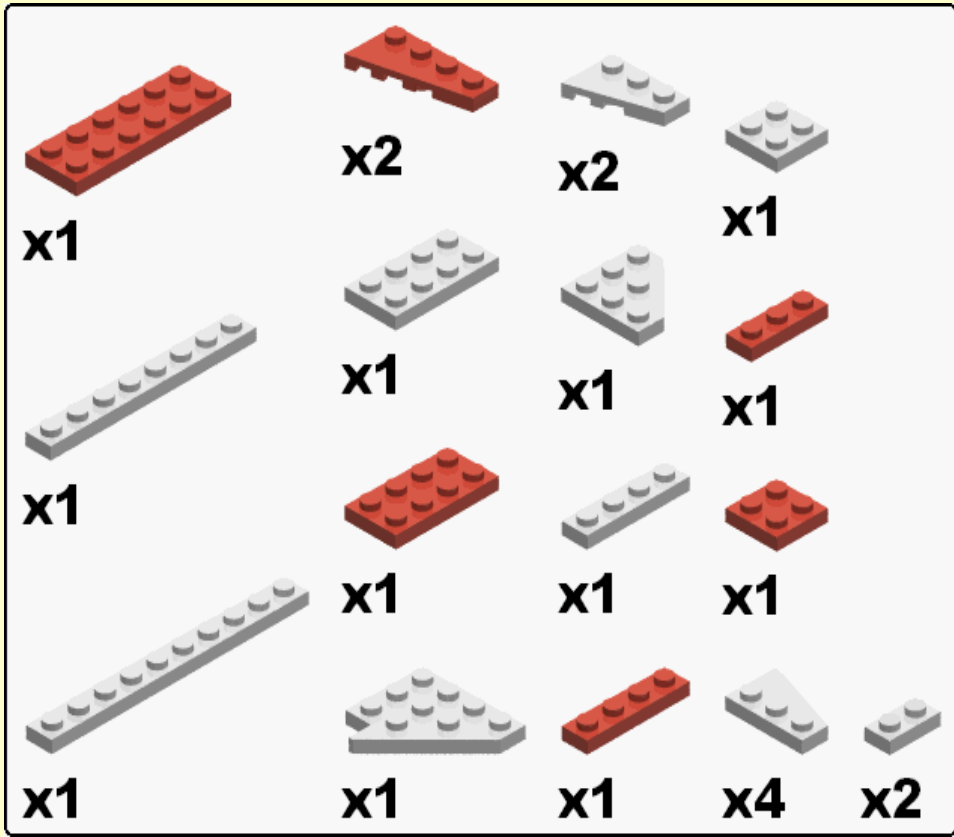

















	
<b>x2</b>	
	
<b>x1</b>	
	
<b>x1</b>	<b>x1</b>
	
	<b>x2</b>

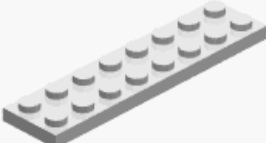

1







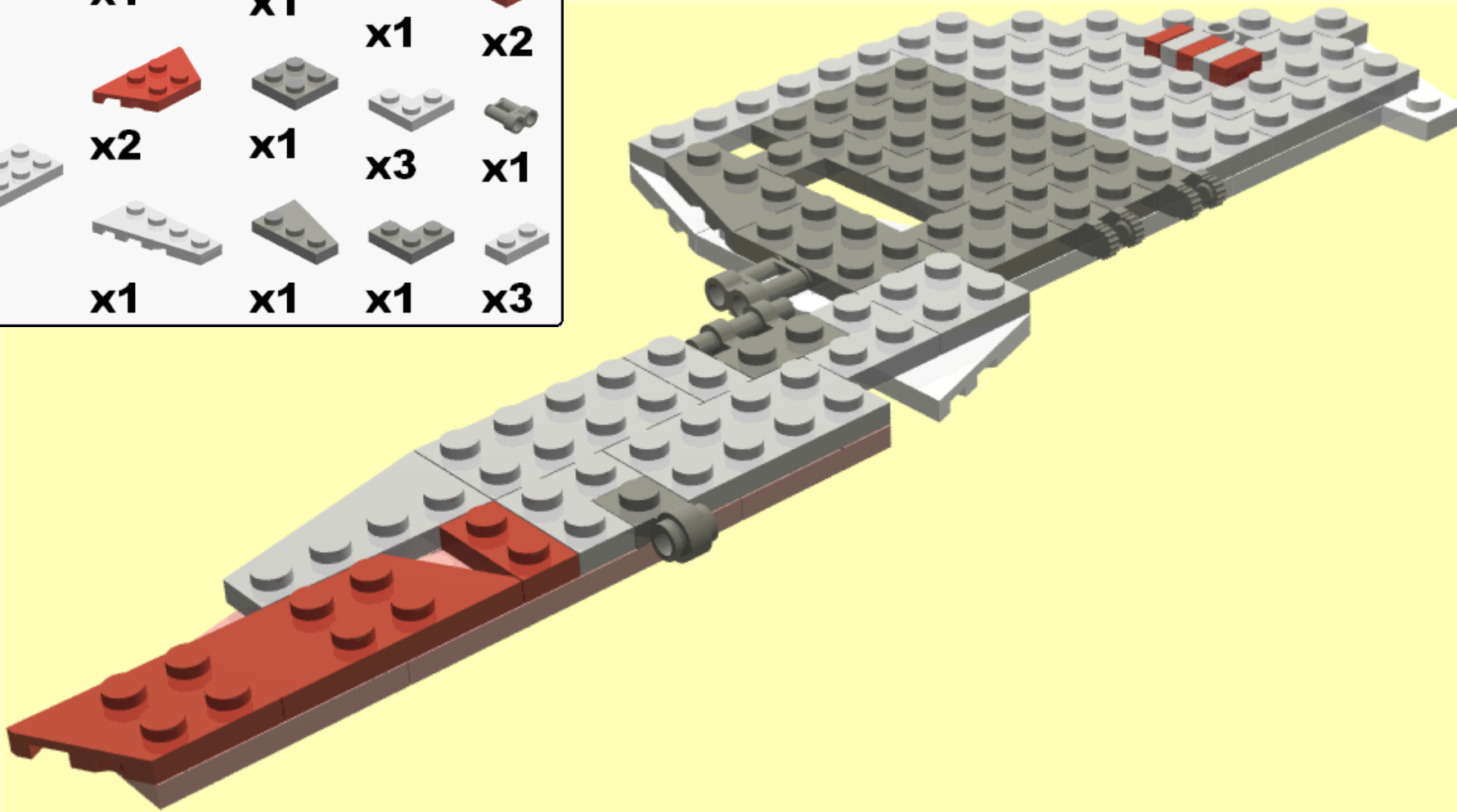



















# 2

 x2	 x1	 x1	 x2	 x1
 x1	 x1	 x2	 x2	 x1
 x1		 x1	 x1	 x1
				 x3
				 x2
 x1	 x2	 x1	 x3	 x1
	 x1	 x1	 x1	 x3



# 3

 x1	 x1	 x1	 x1
 x1	 x1	 x5	 x1
 x1	 x1	 x1	 x3
 x1	 x2	 x1	 x6
 x1	 x1	 x3	 x2
 x1	 x2	 x2	 x1

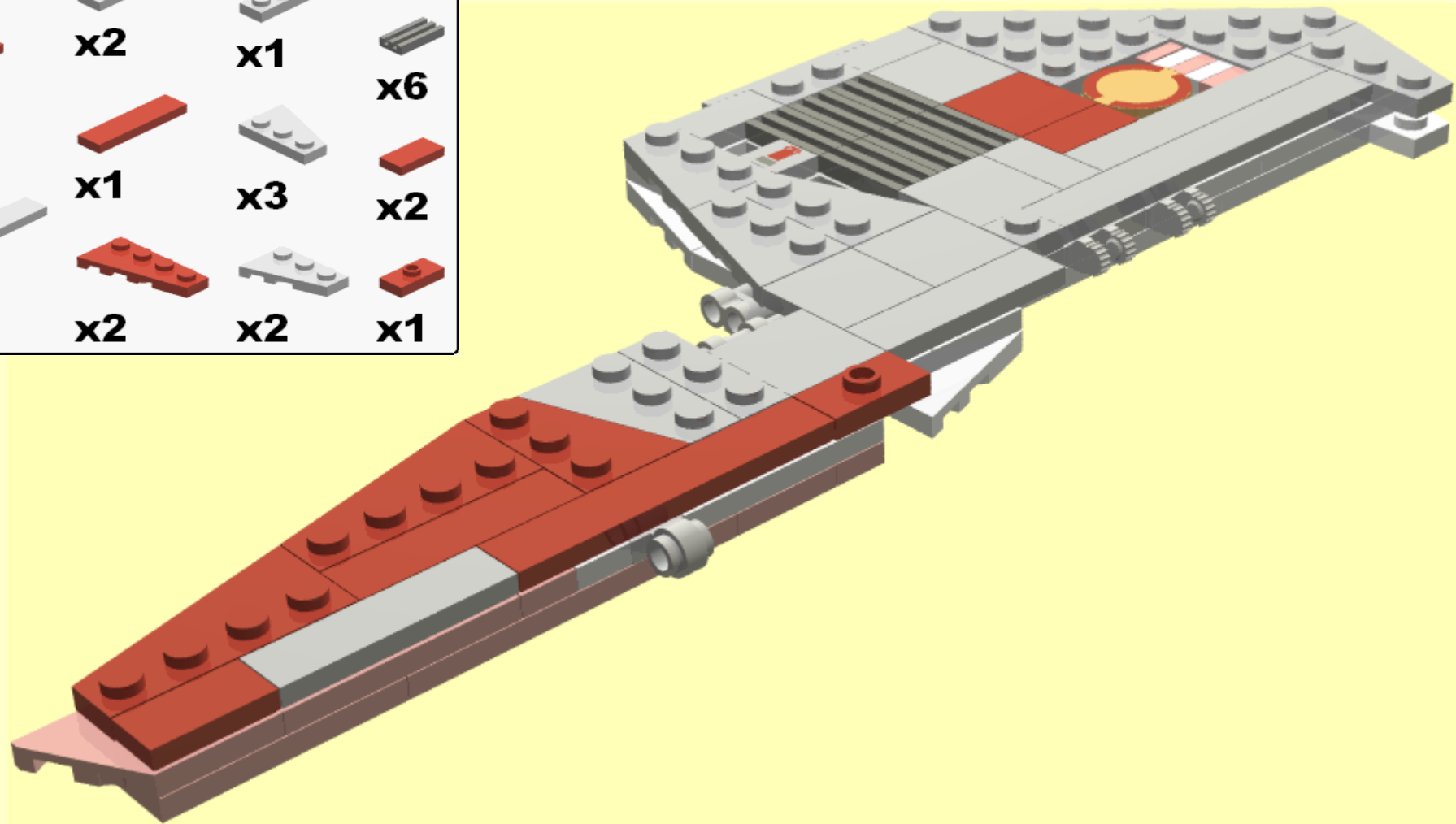

4

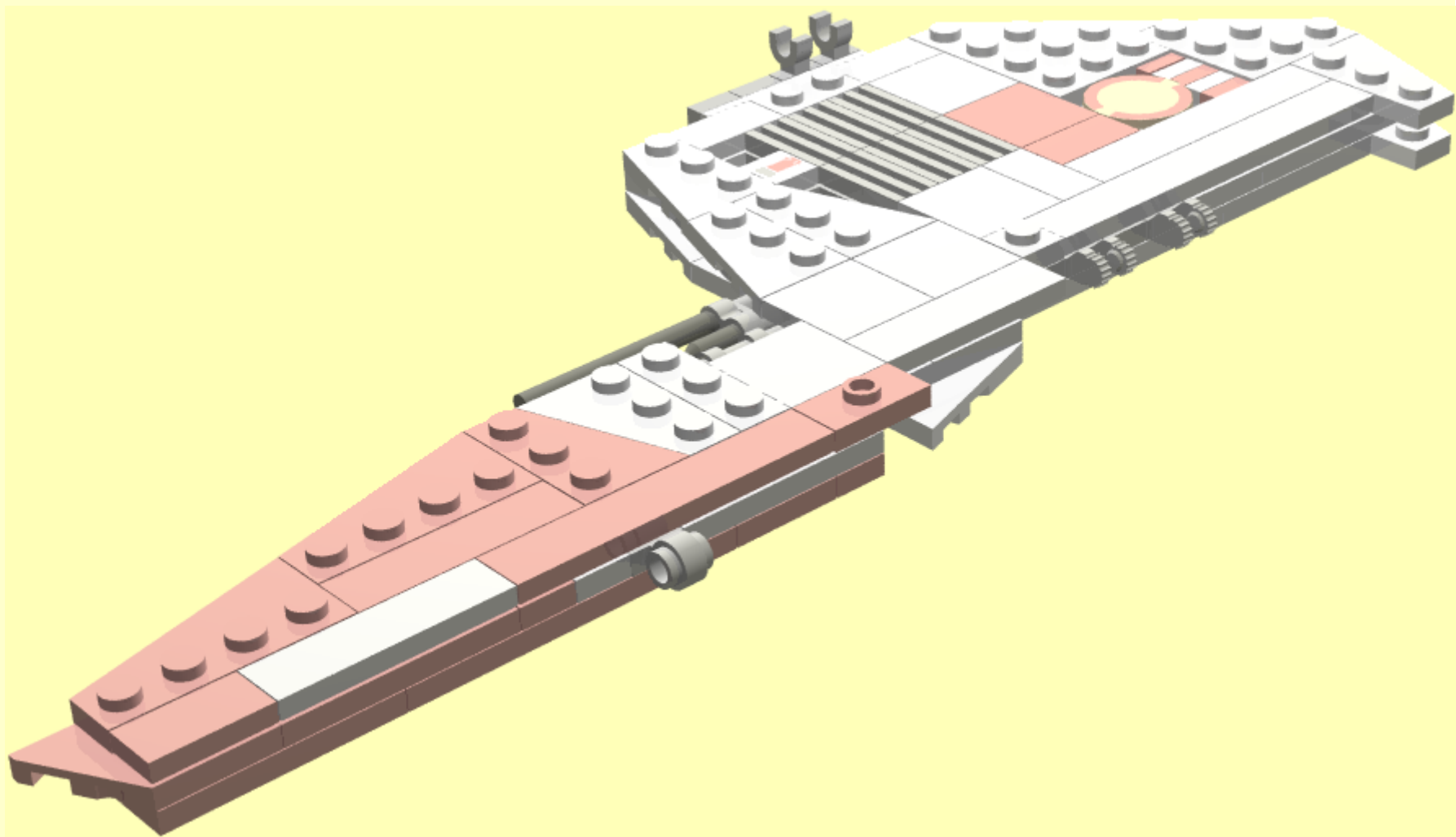
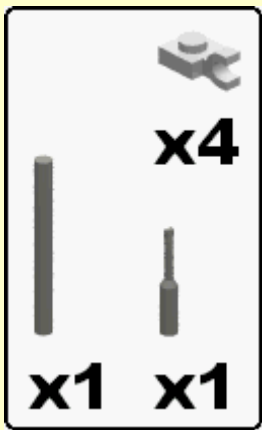

**5**

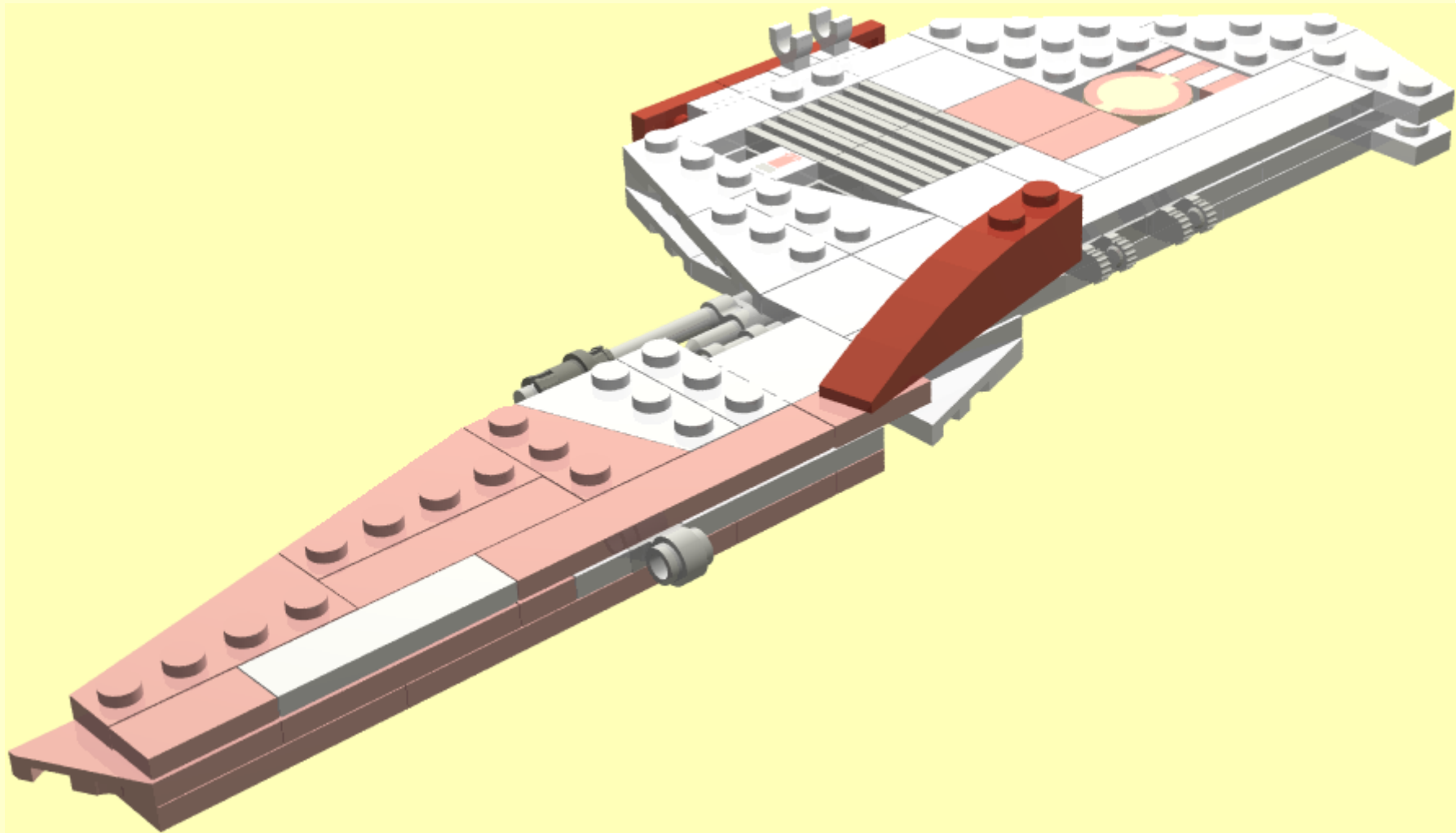
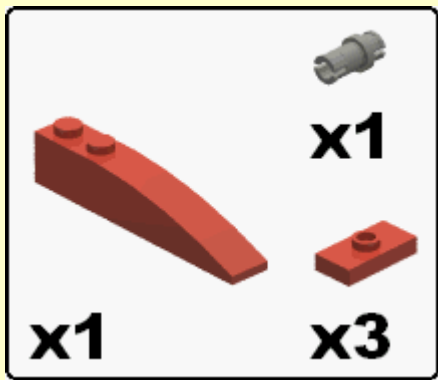



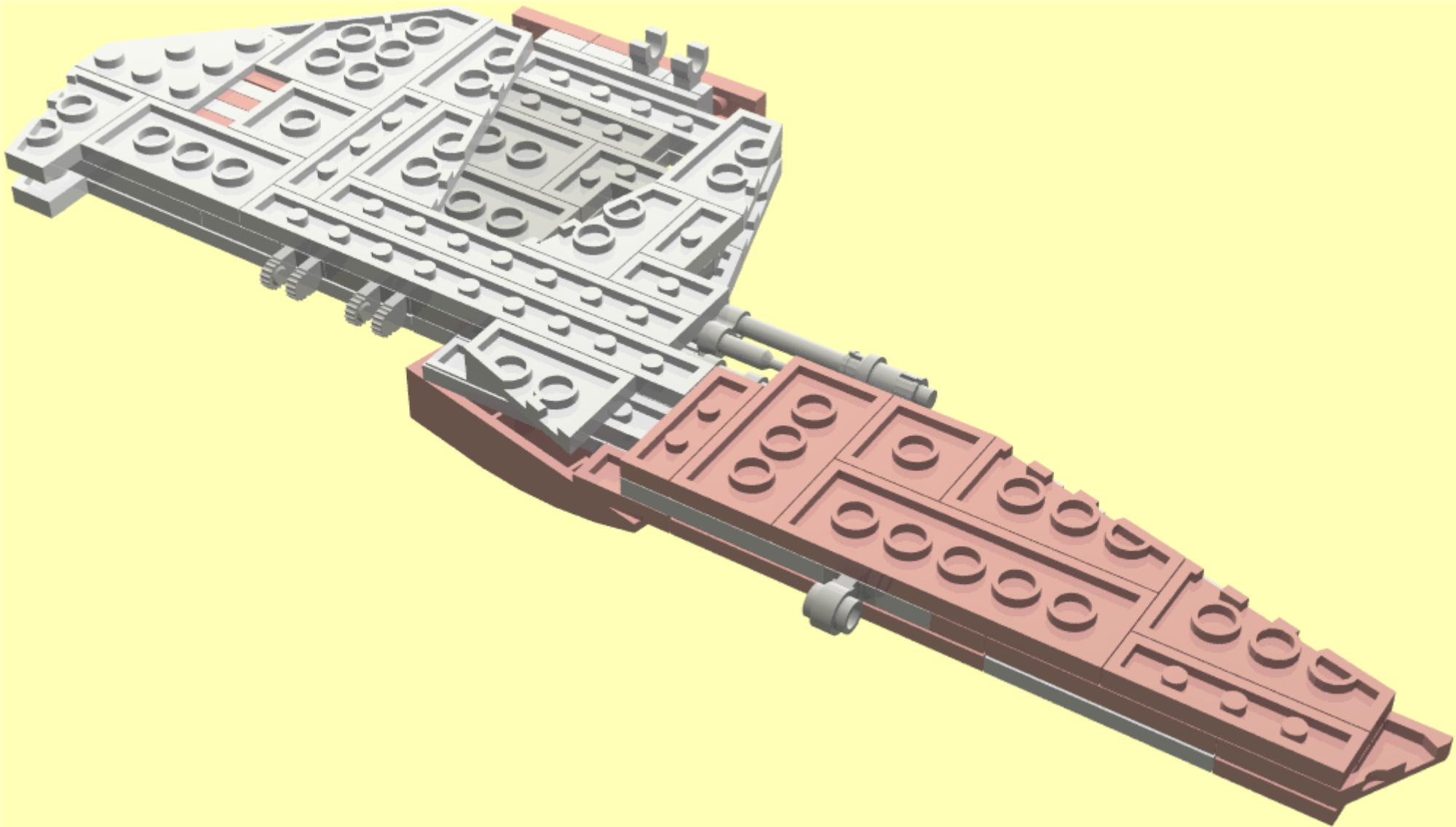

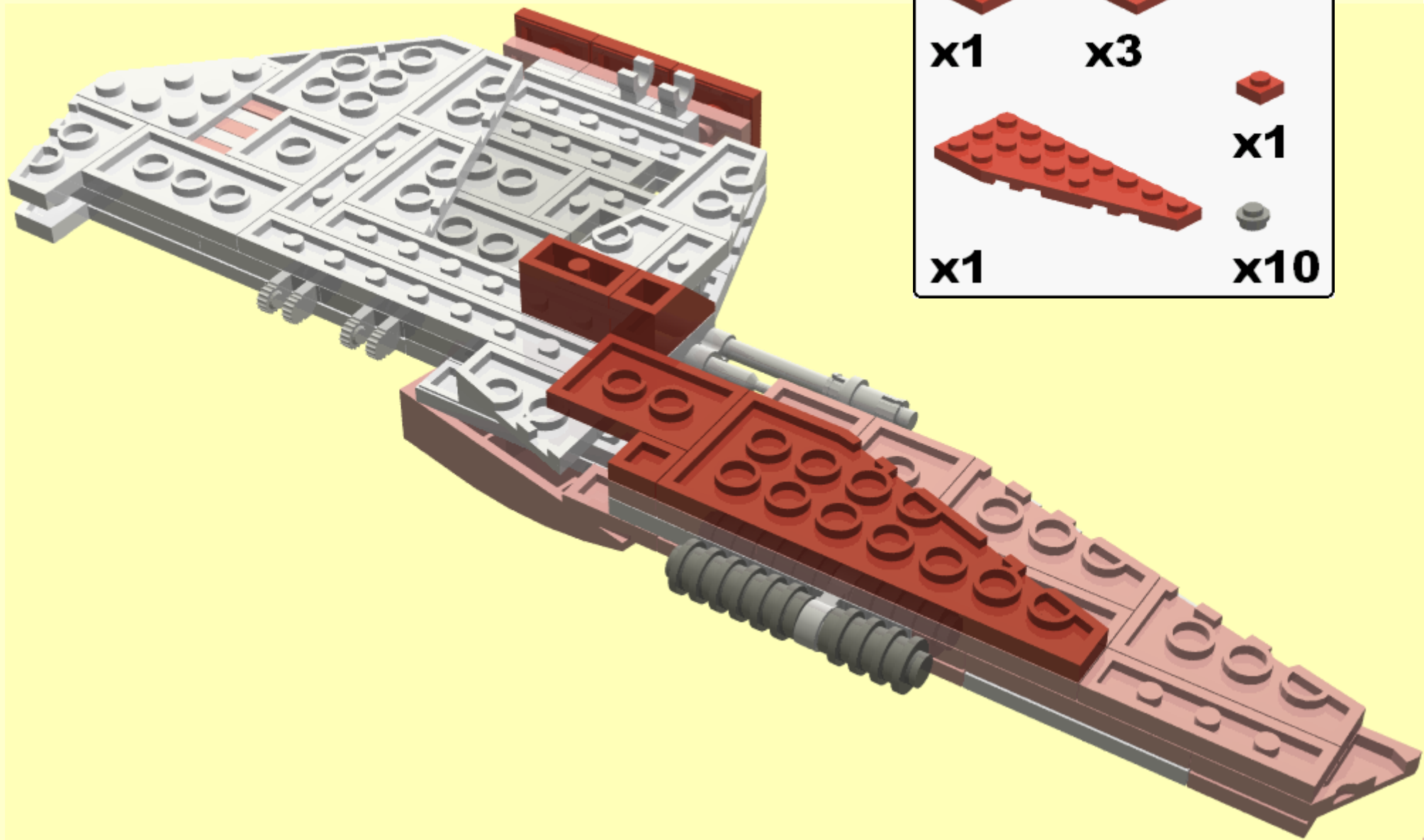

6



7

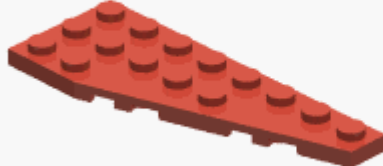





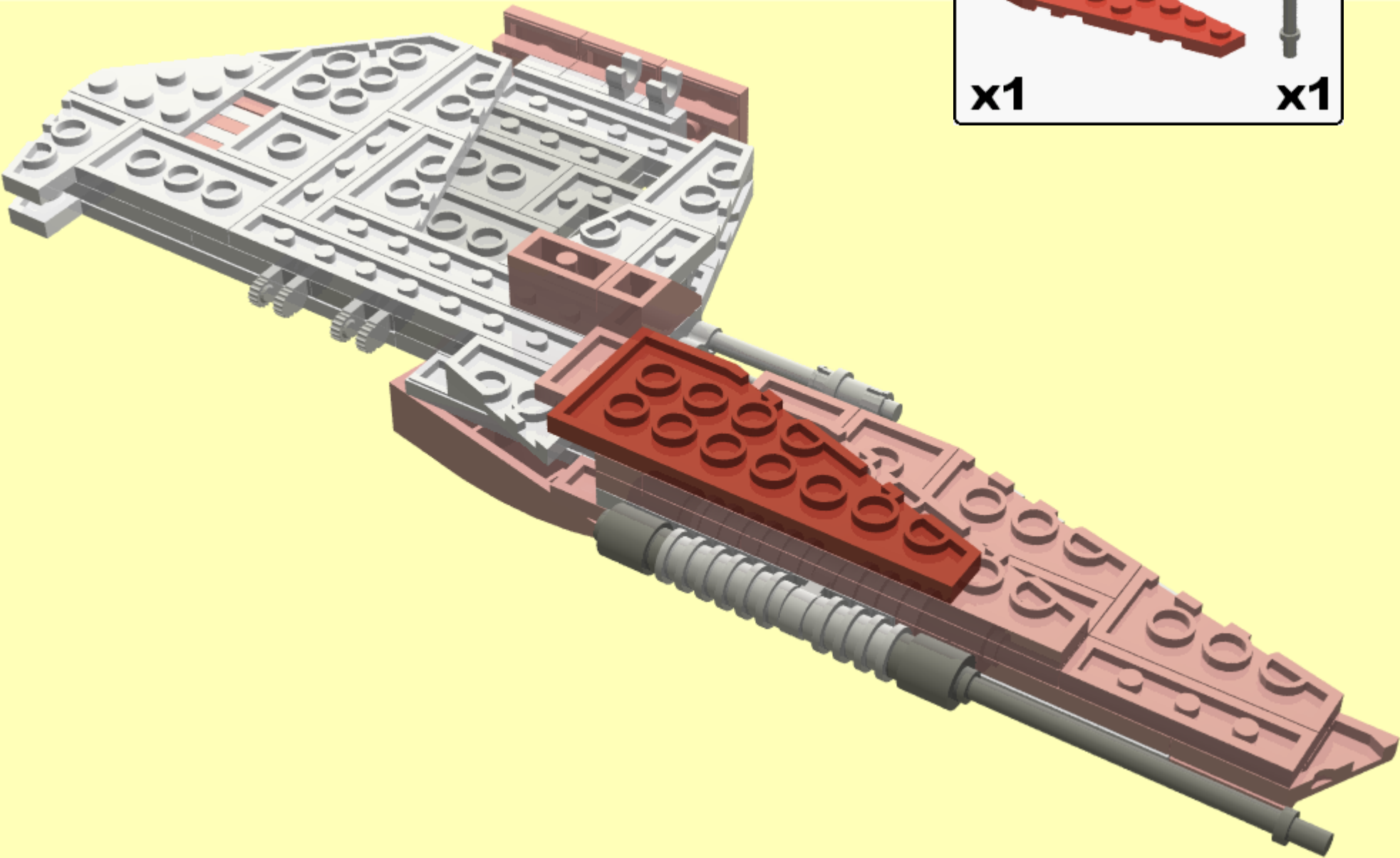
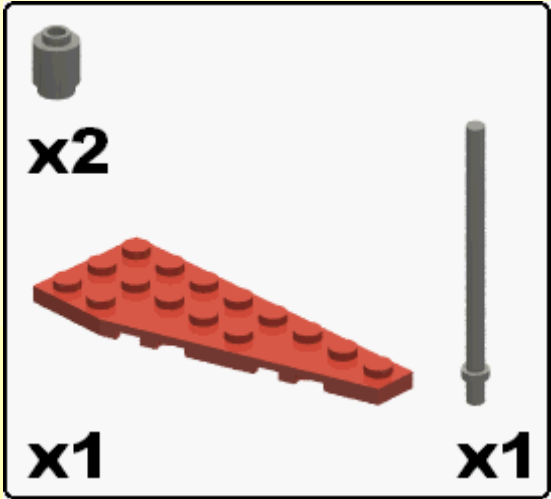

	
<b>x1</b>	<b>x1</b>
	
<b>x1</b>	<b>x3</b>
	
<b>x1</b>	<b>x1</b>
	
	<b>x10</b>

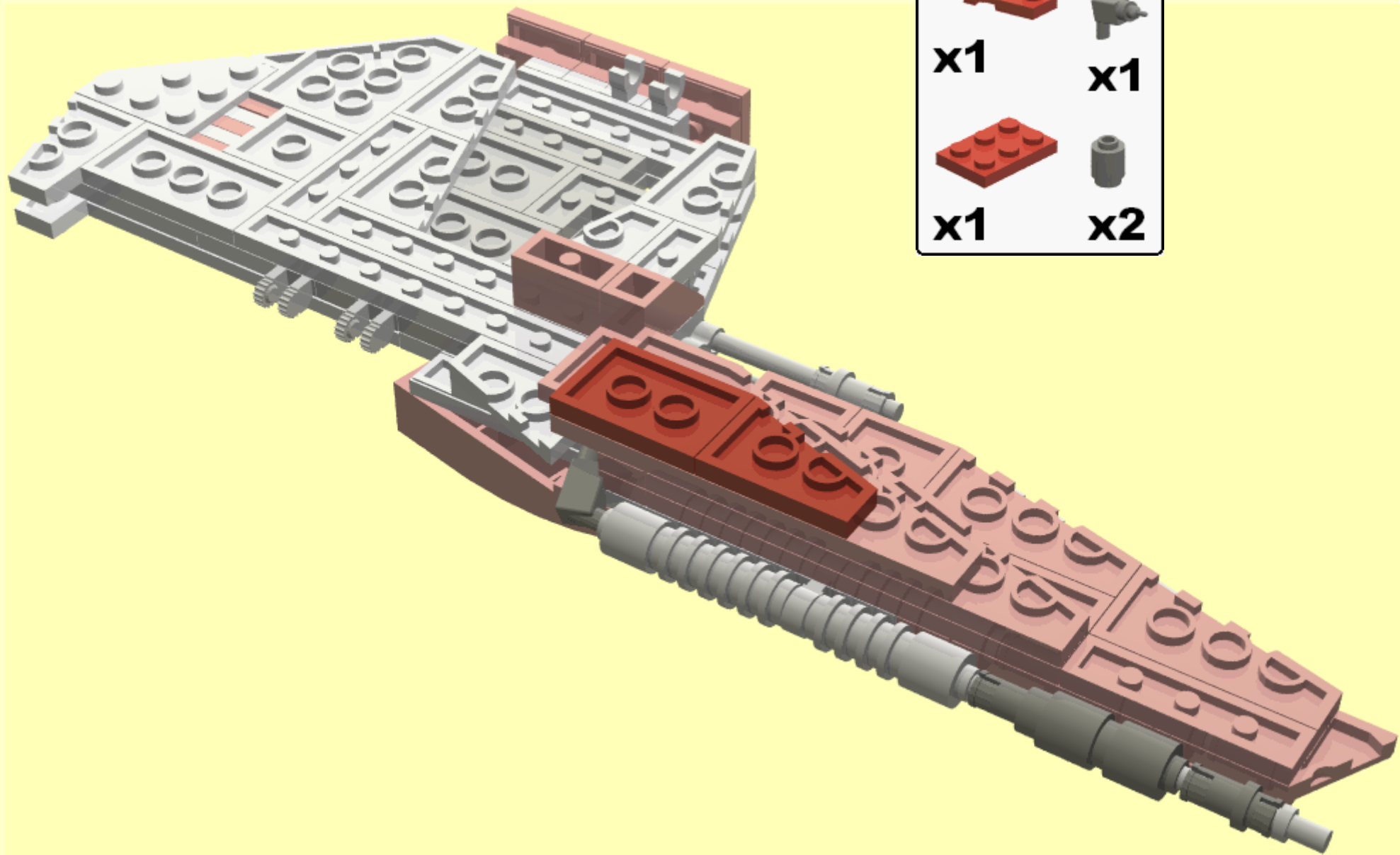
8



9



-  x2
-  x1
-  x1
-  x1
-  x2

