

Ultimate Collector Series Republic V-Wing Fighter

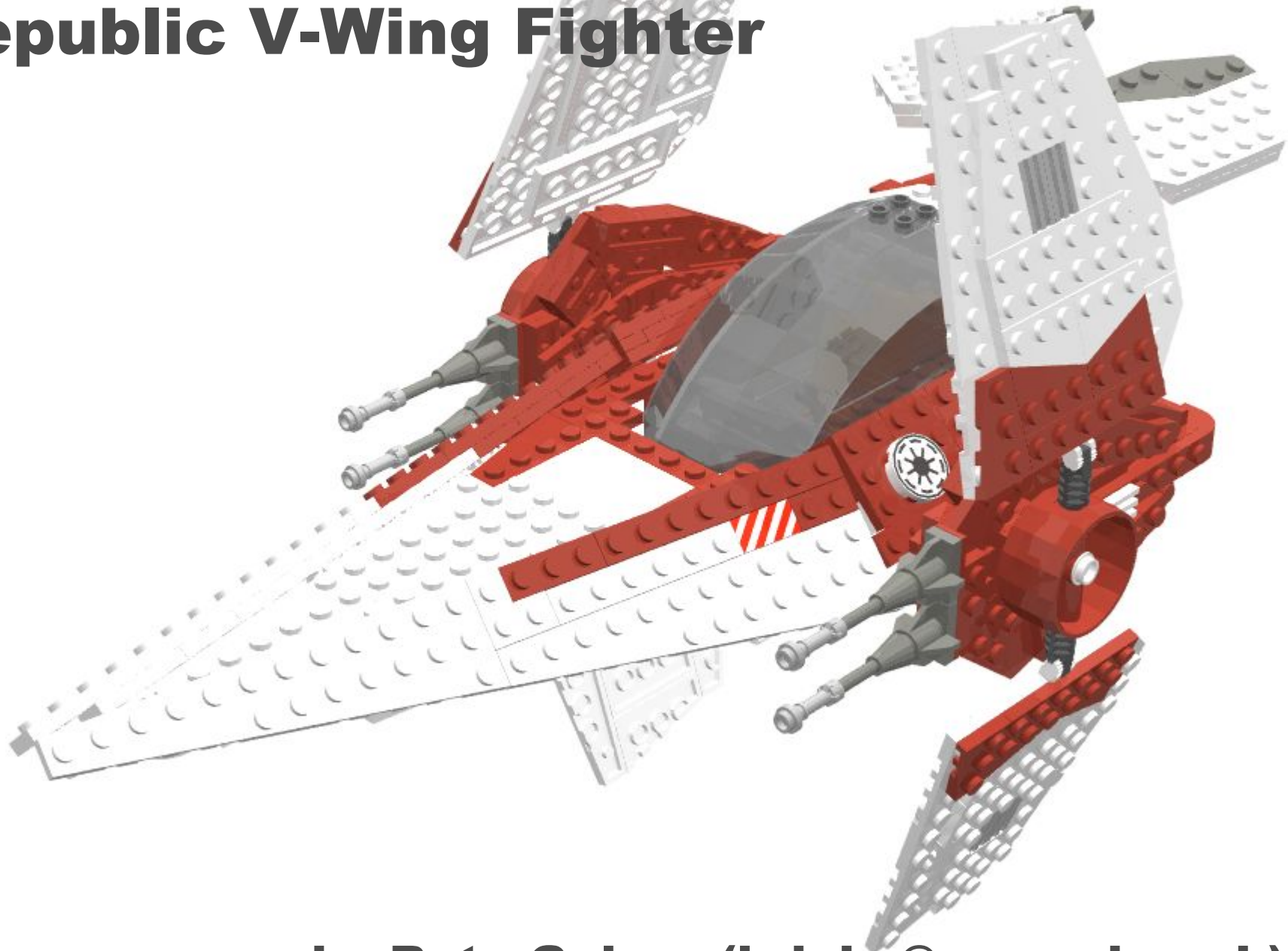

by Reto Geiger (bricks@enerprice.ch)

1/24th Scale UCS V-Wing Fighter

by Reto Geiger (bricks@enerprice.ch)

For a parts list, see separate parts.txt file.

These instructions are meant for personal use only. If you want to use them for commercial purposes (eg. selling on eBay), contact me first to get my consent. I reserve the right not to grant this permission. Thanks for your understanding!

1

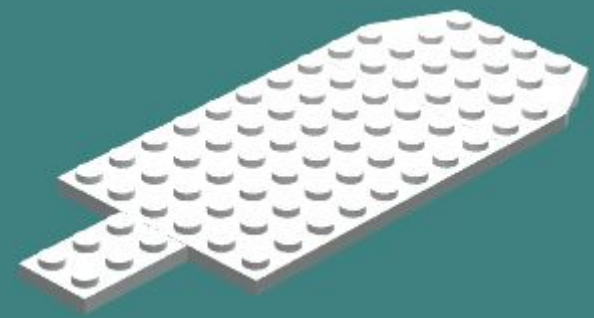
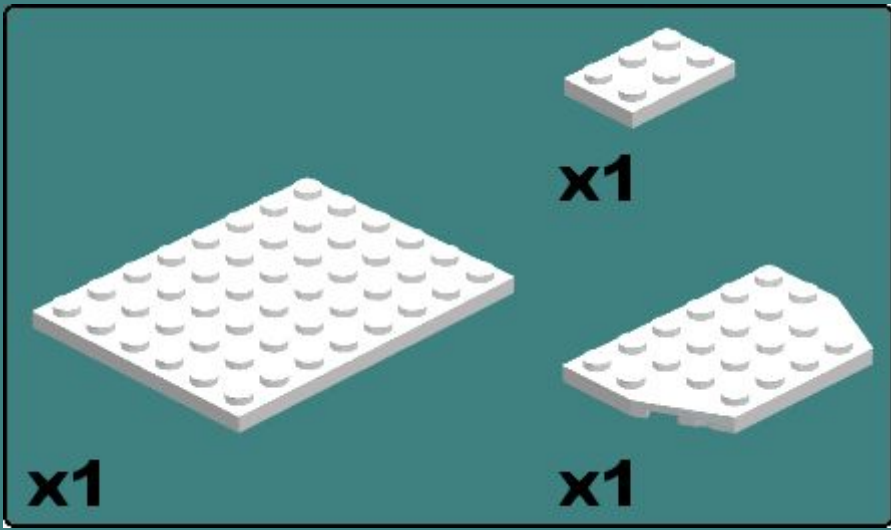

2

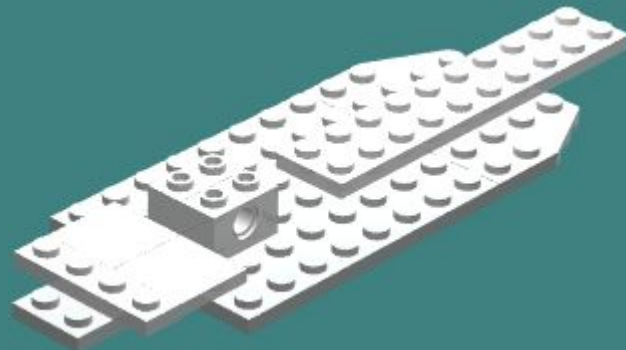
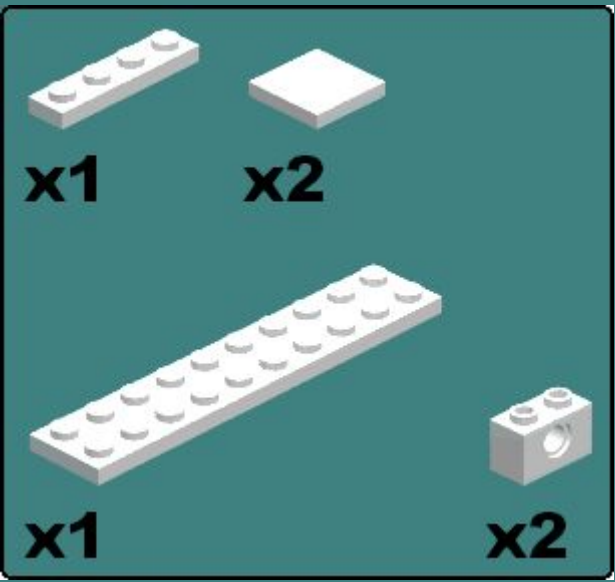

3



x3



x1



x1



x1



x2



x1

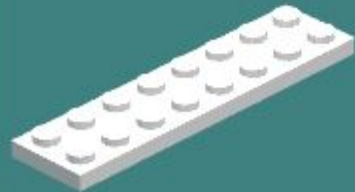

x1



x1

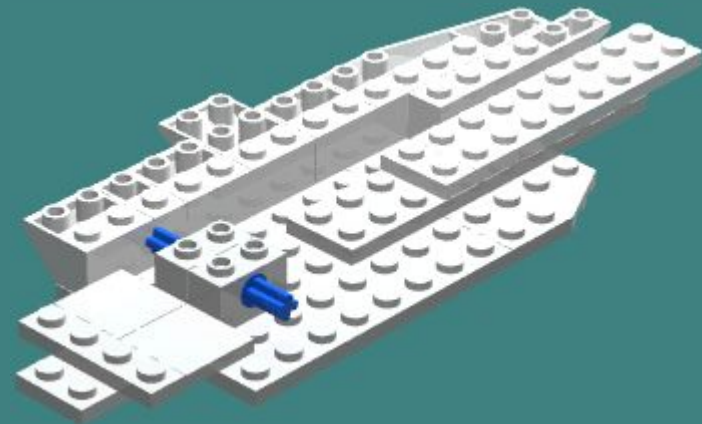

4

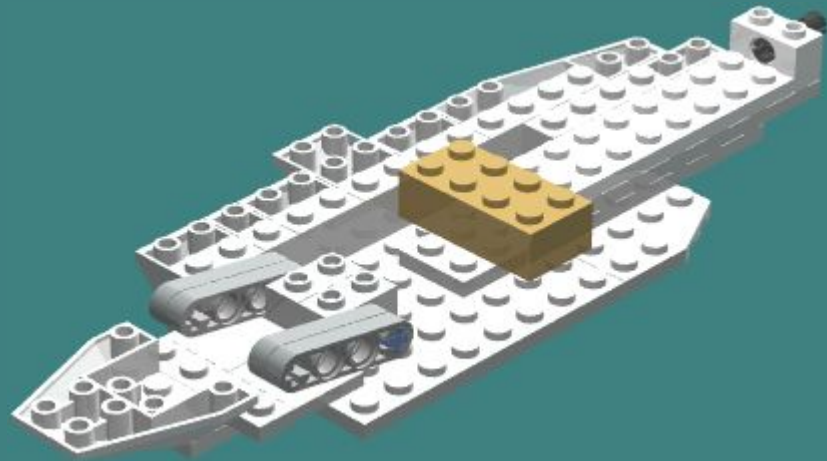
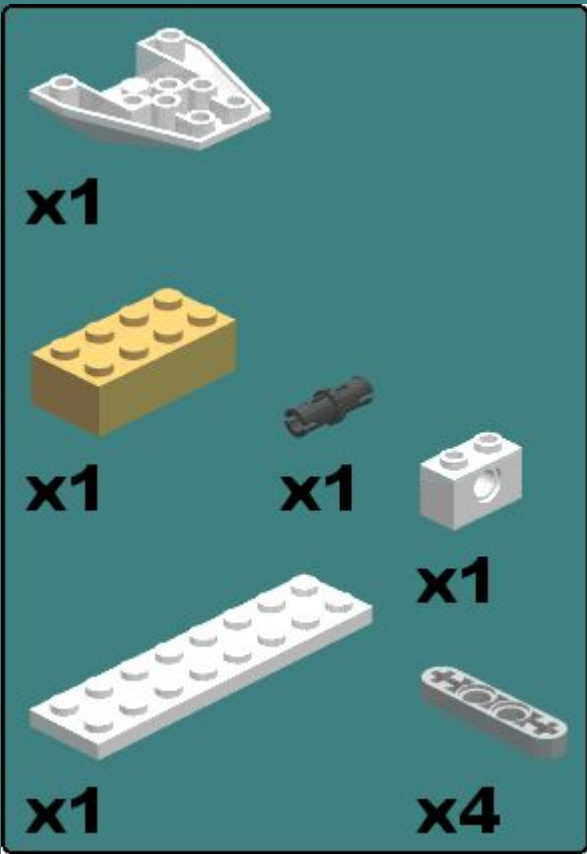

5



x3



x2



x1



x1



x1



x2



x1



x1

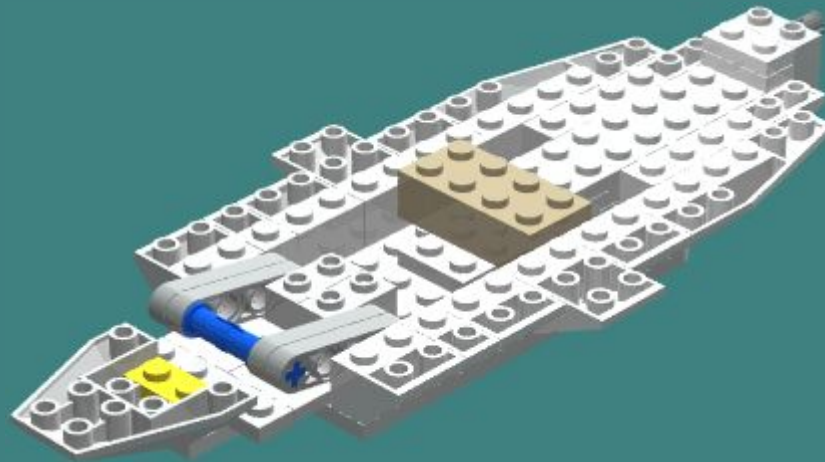



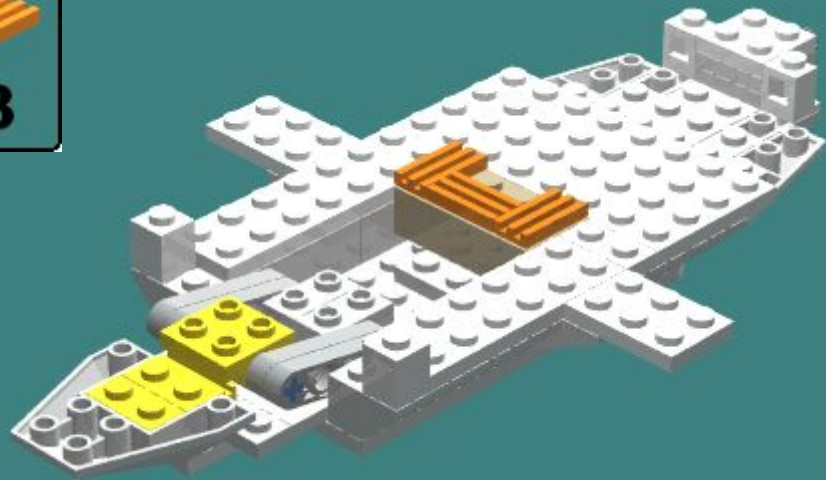
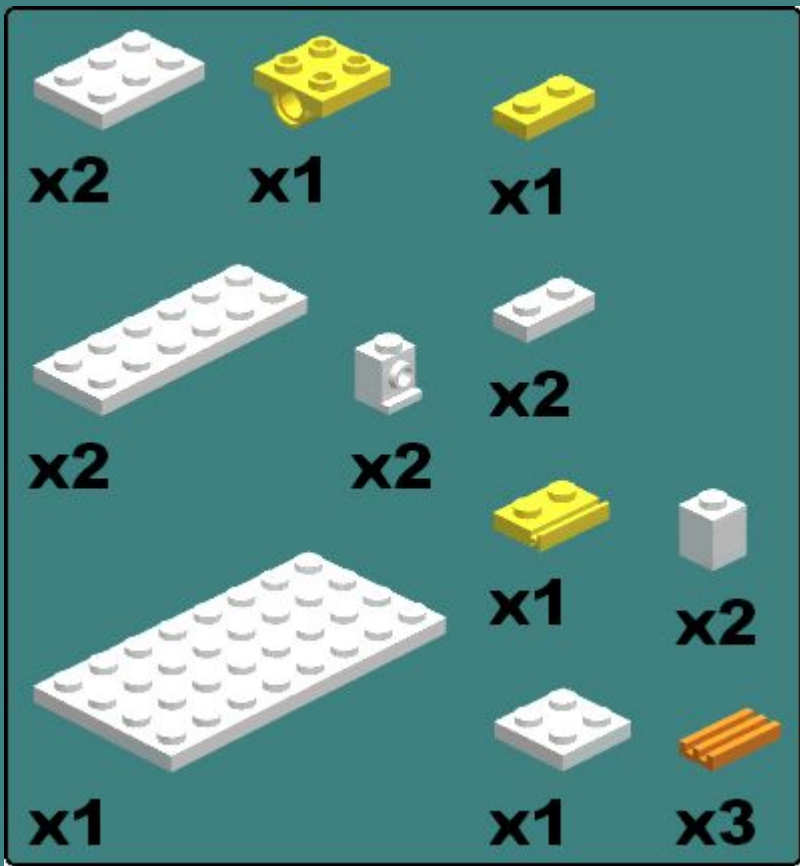



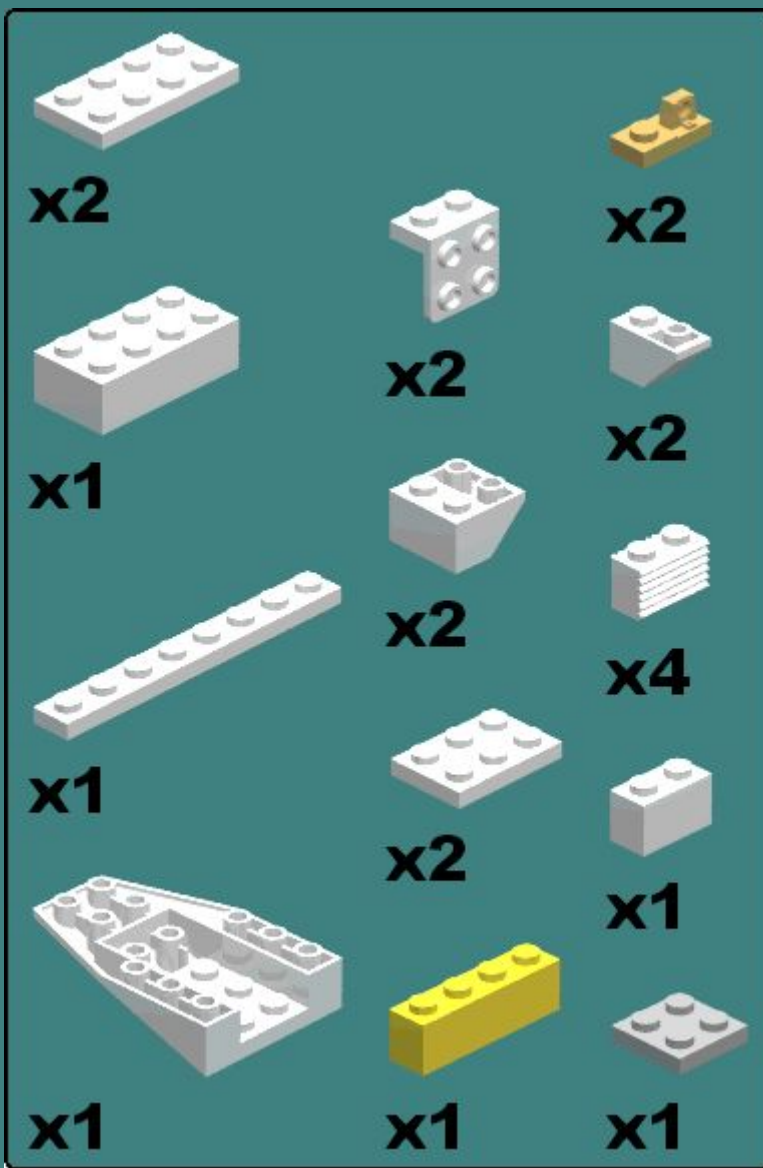





6



7



8

		
x2	x1	x1
		
x1	x1	x2
		
x1	x1	x2
		
x1	x1	x2

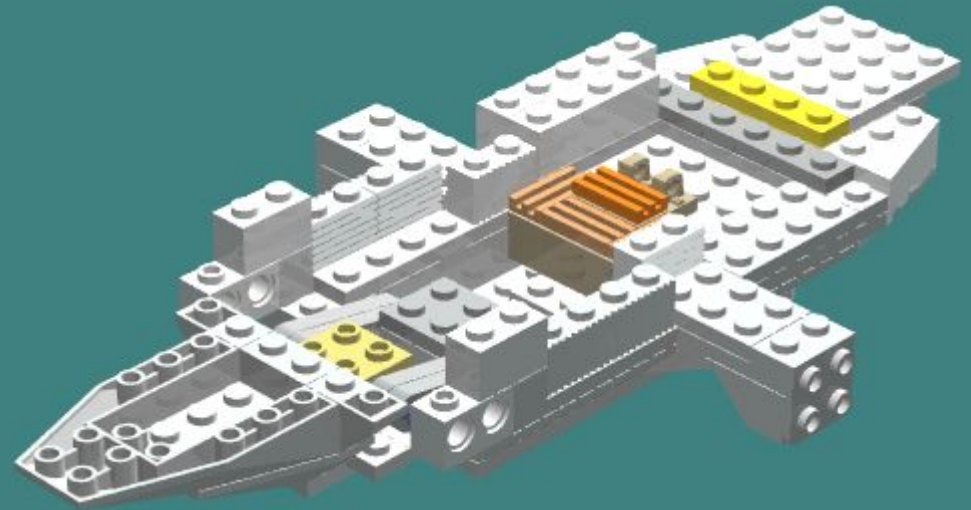

1

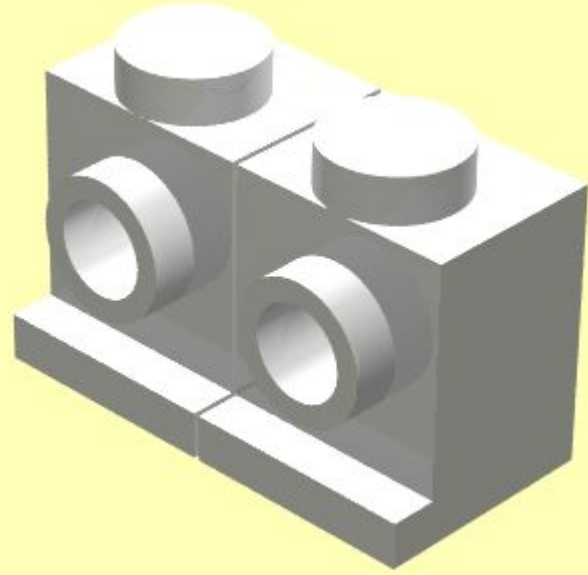

2



x1



x1

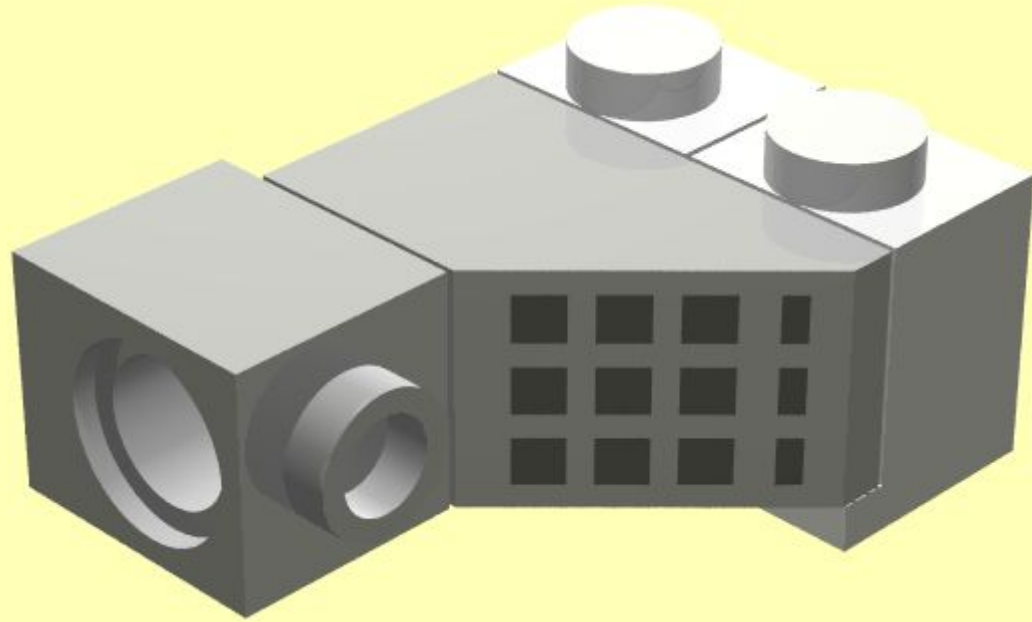

3

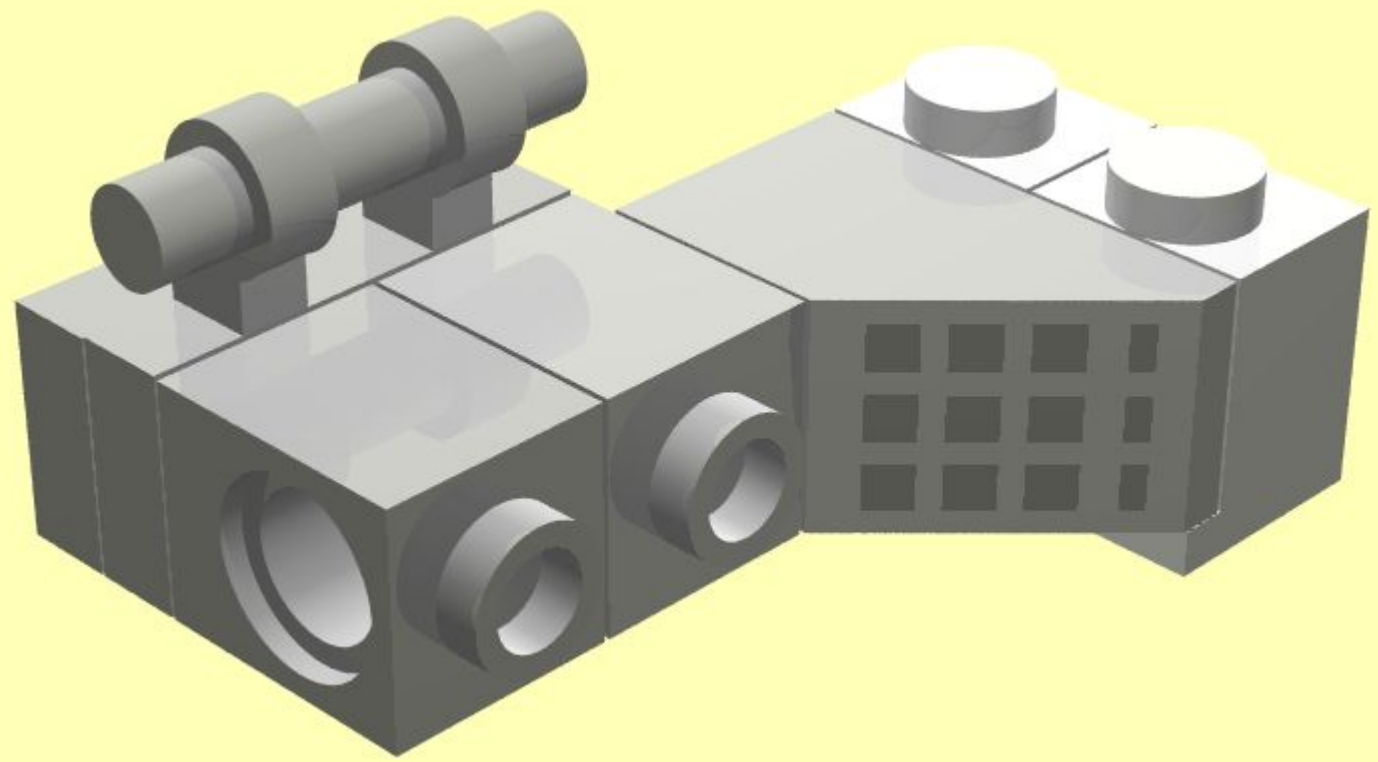
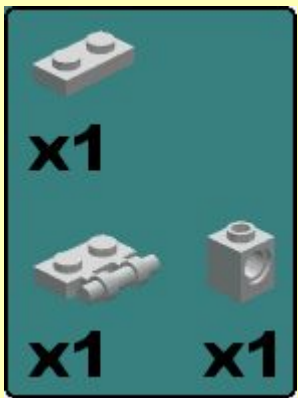

4





x2

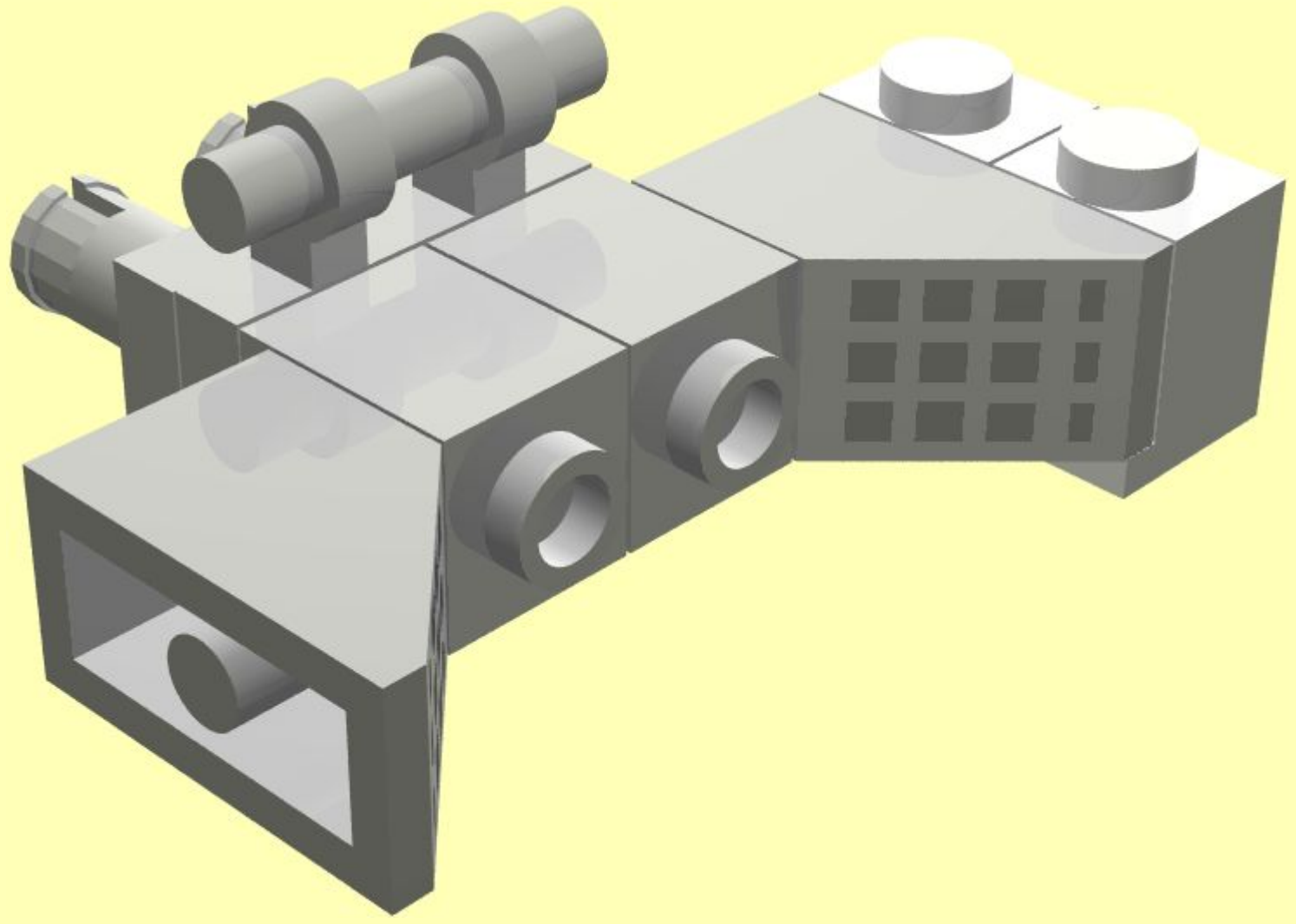

x1



5

	
x2	x1
	
x1	x2

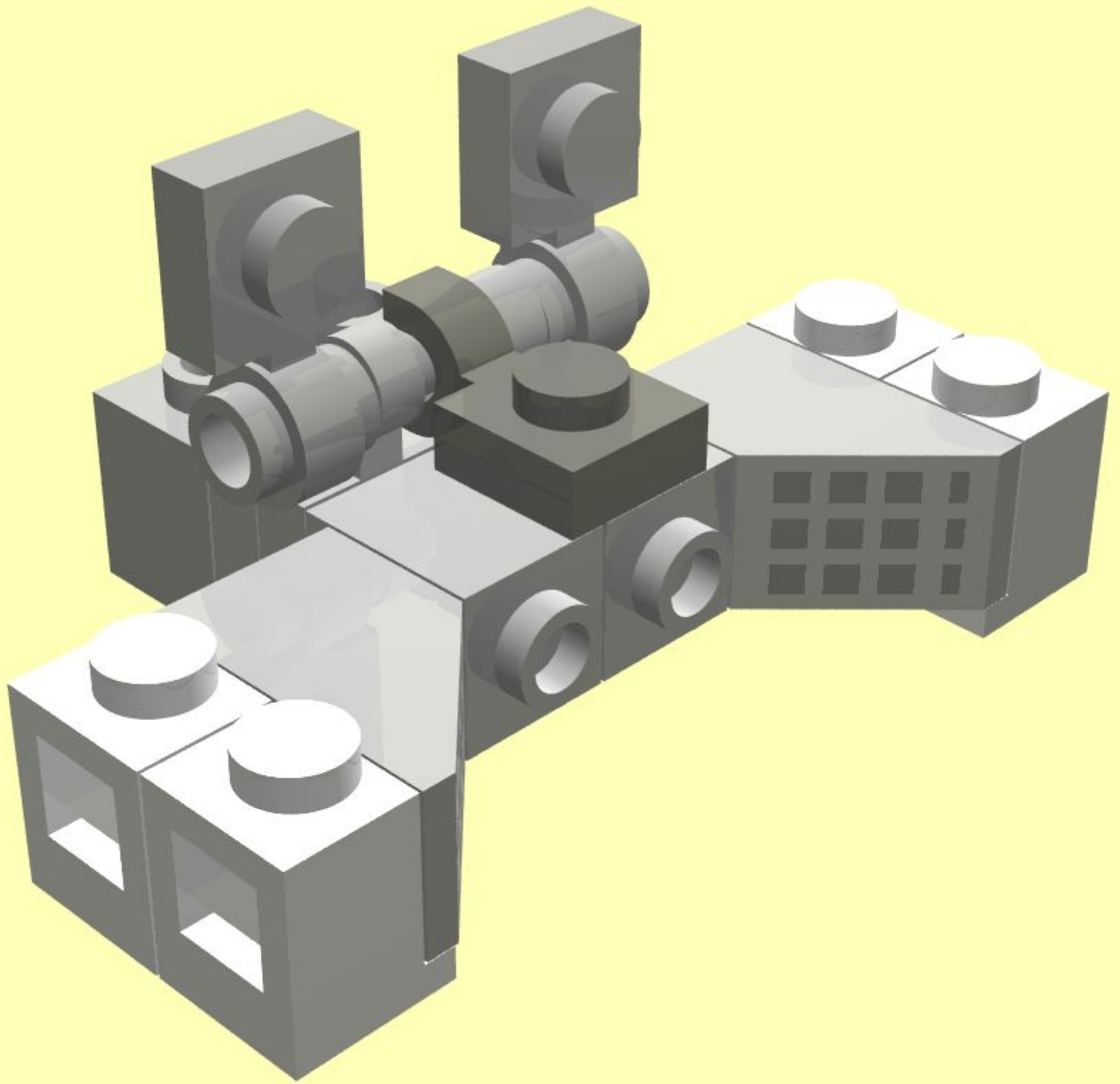

6

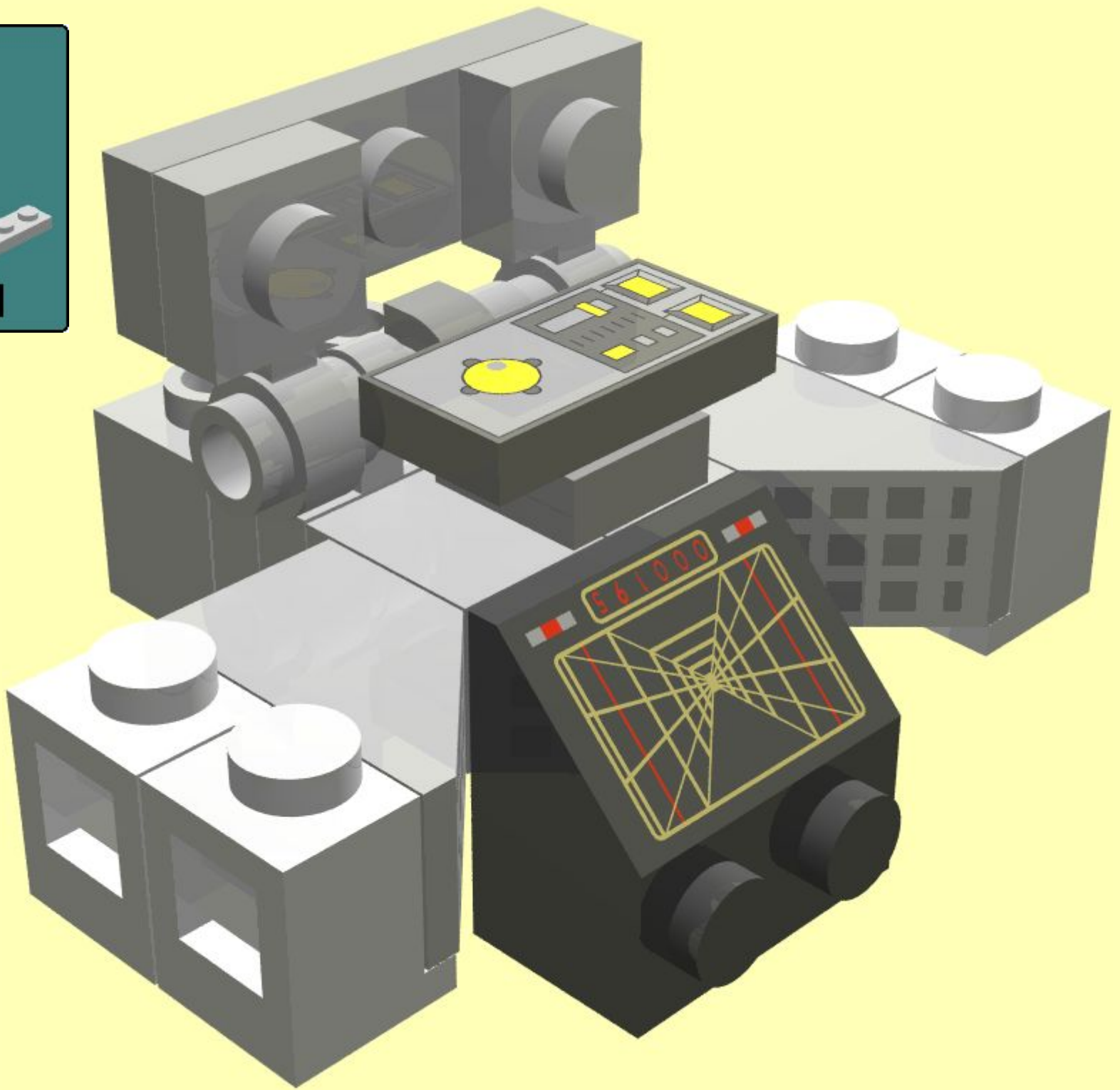
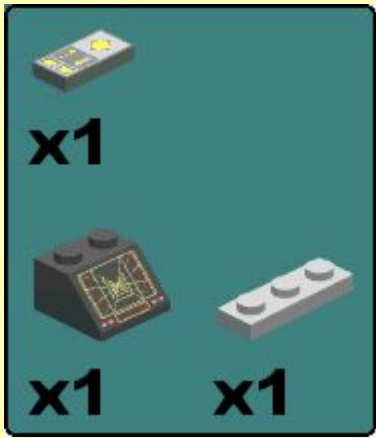

7

-  x1
-  x1
-  x1
-  x1
-  x1

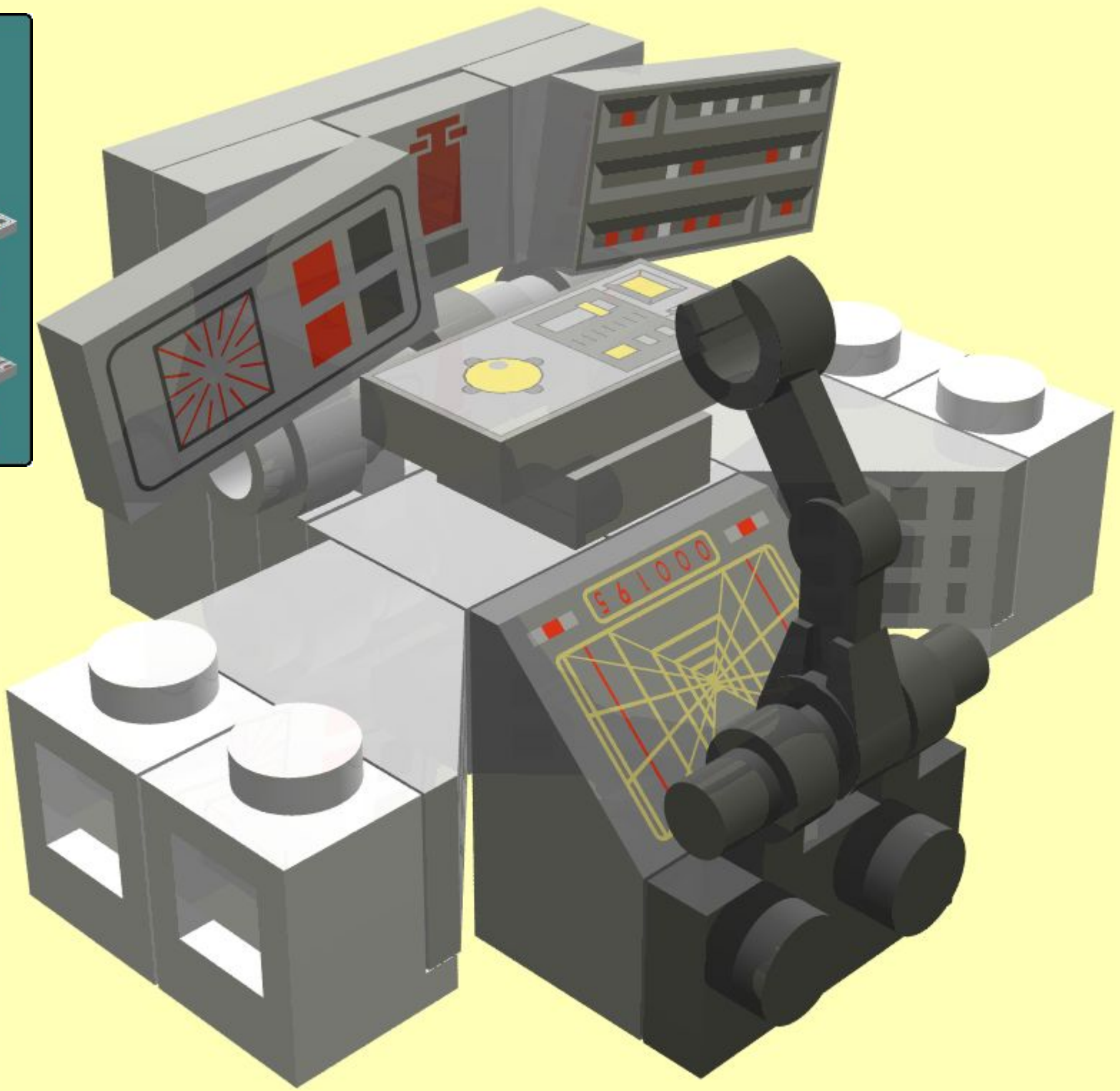

9

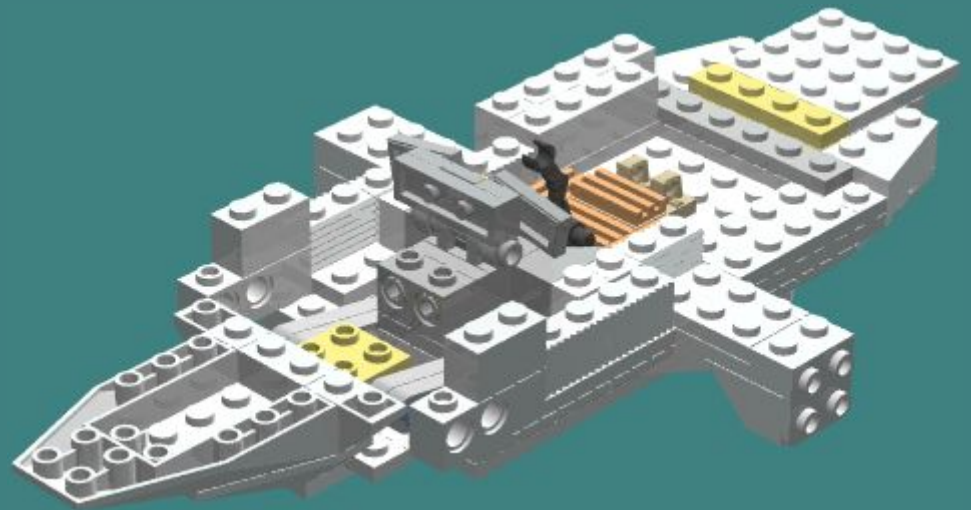

10

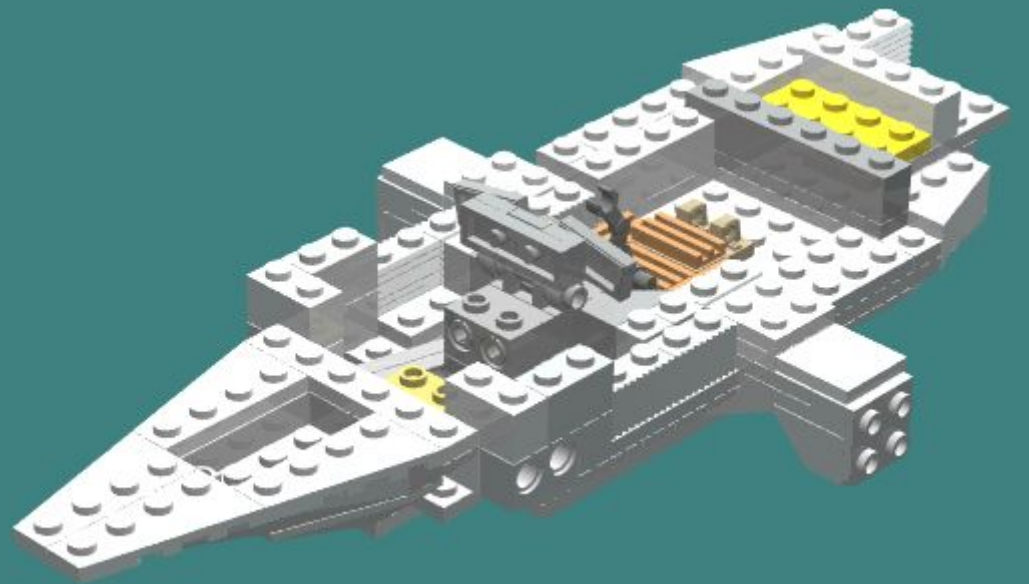
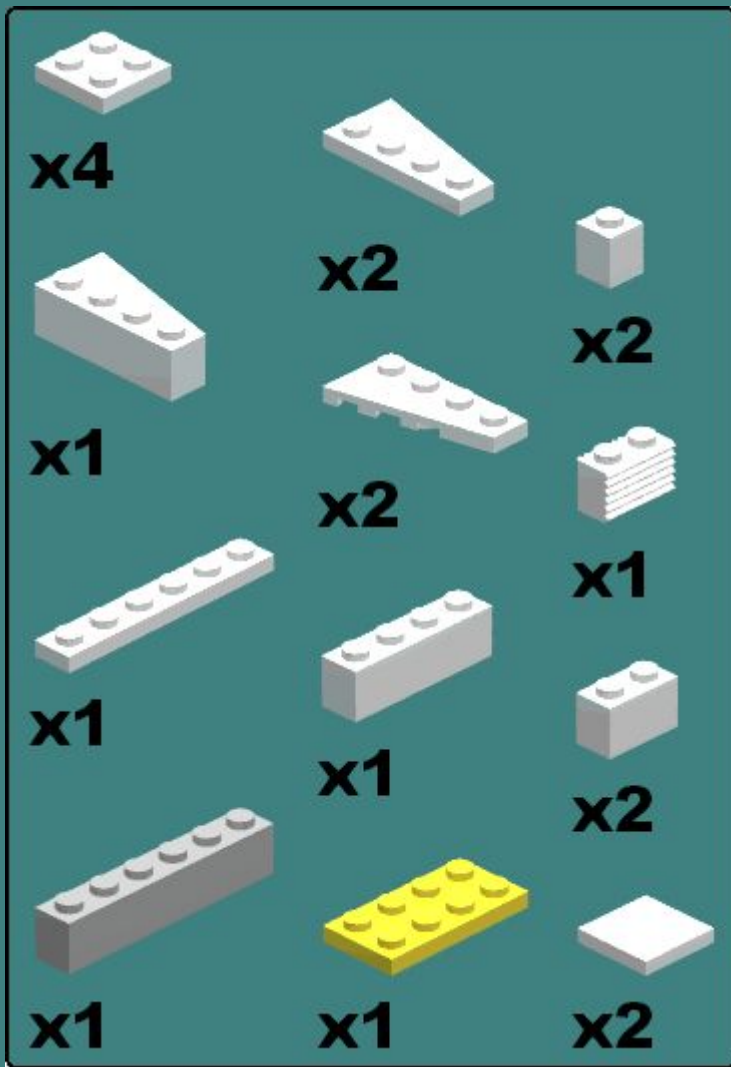



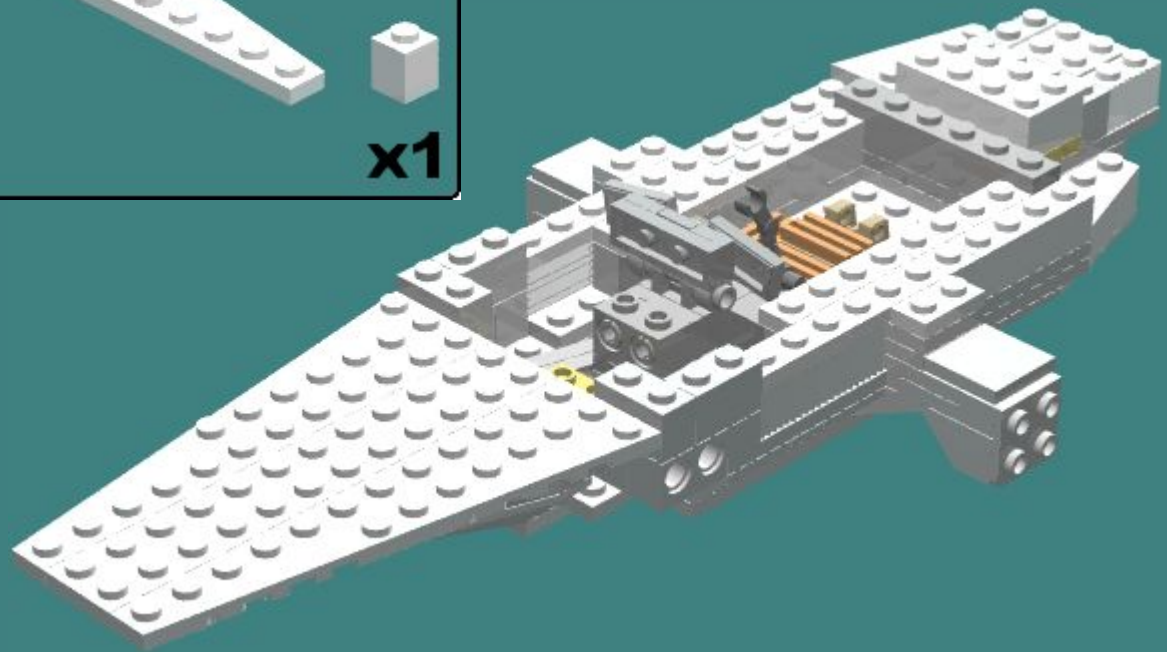
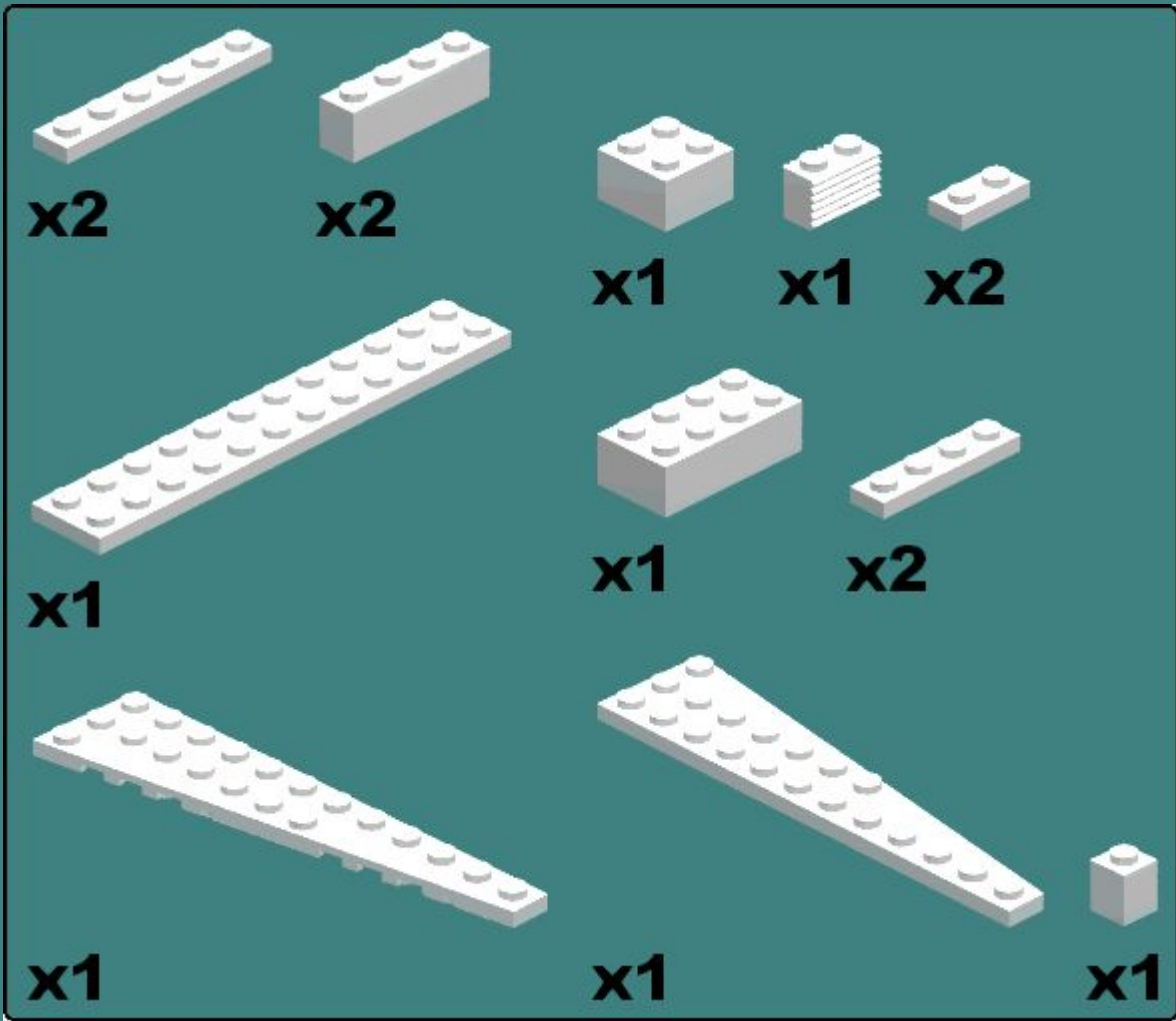



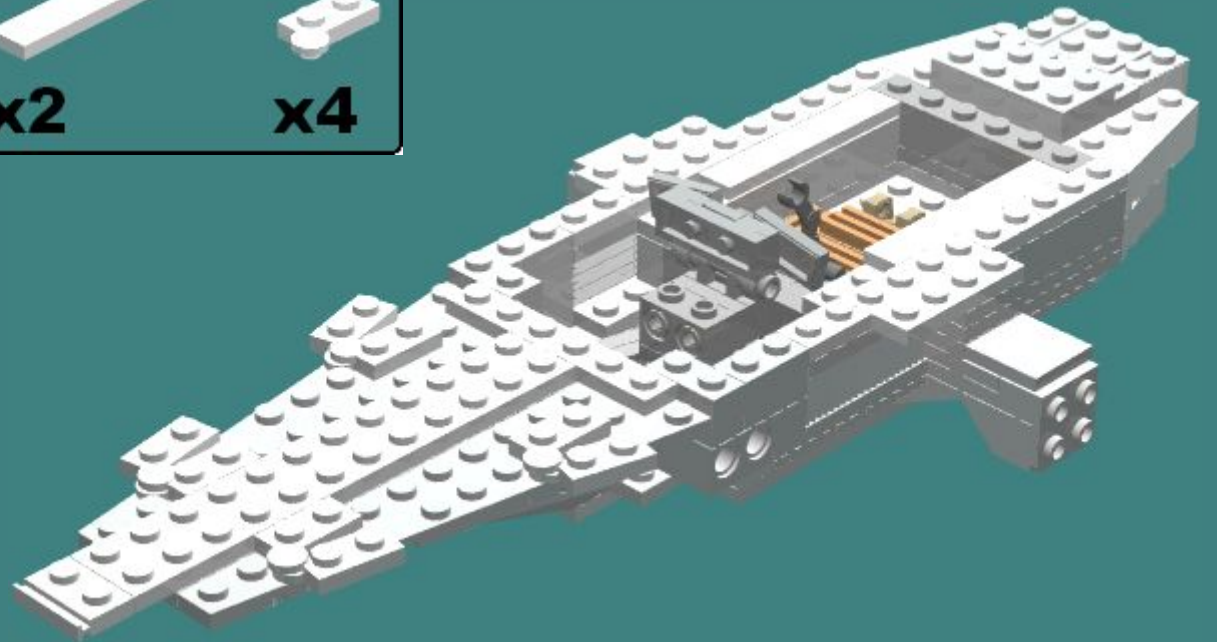
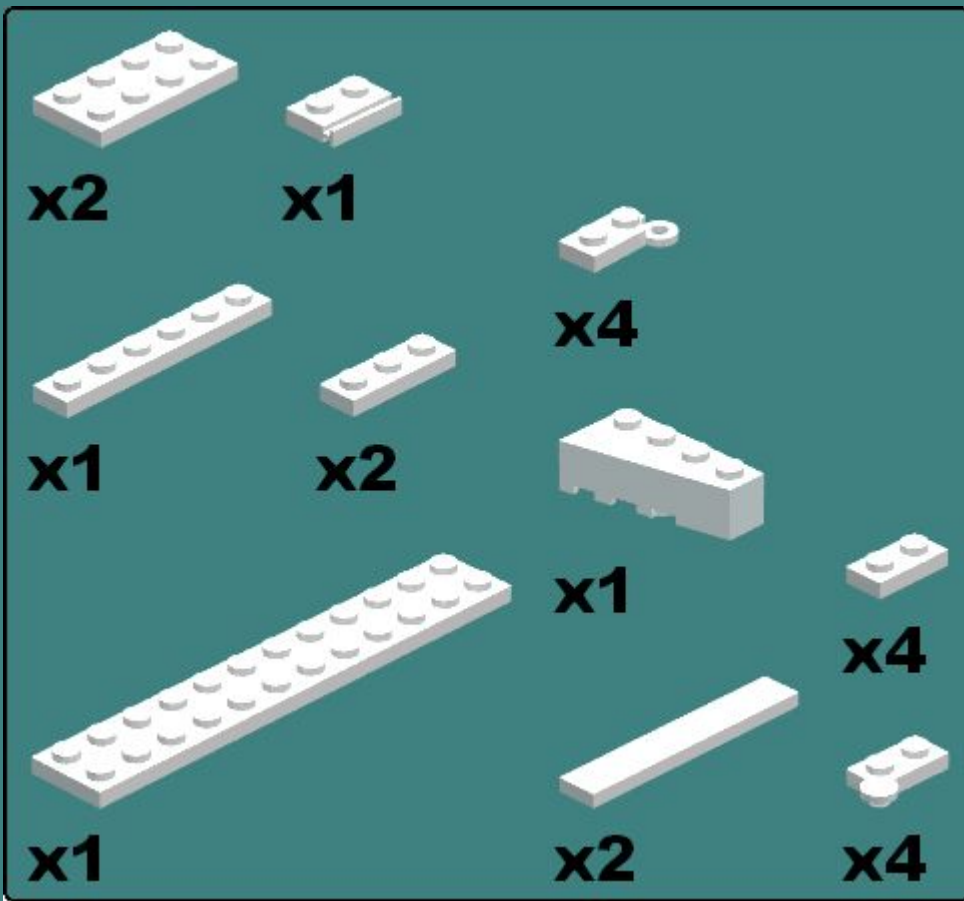



11



12







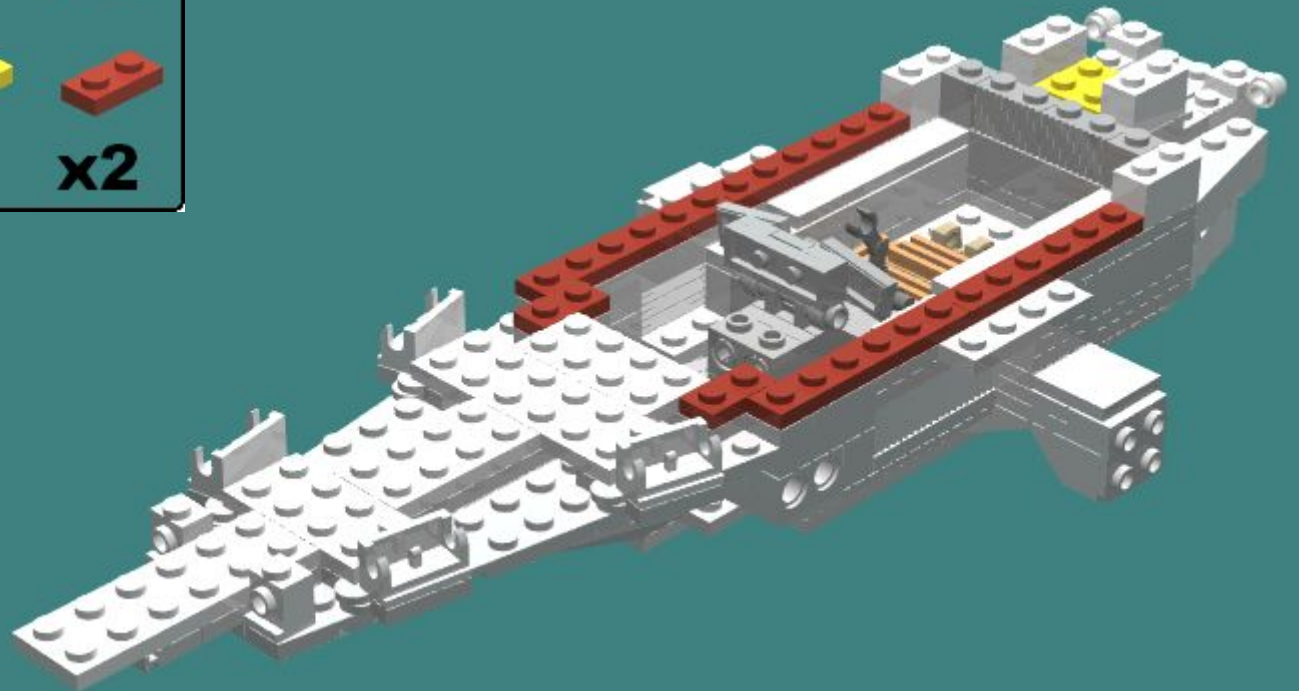







13

		
x3	x4	x2
		
x4	x2	x2
		
x2	x4	x2
		
	x1	x2

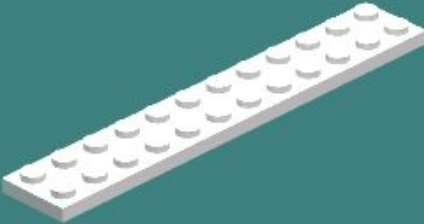

14

	
x4	x1
	
x1	x2
	
x1	x1
	
x2	x2
	
x2	x1
	
x1	x2
	
	x2

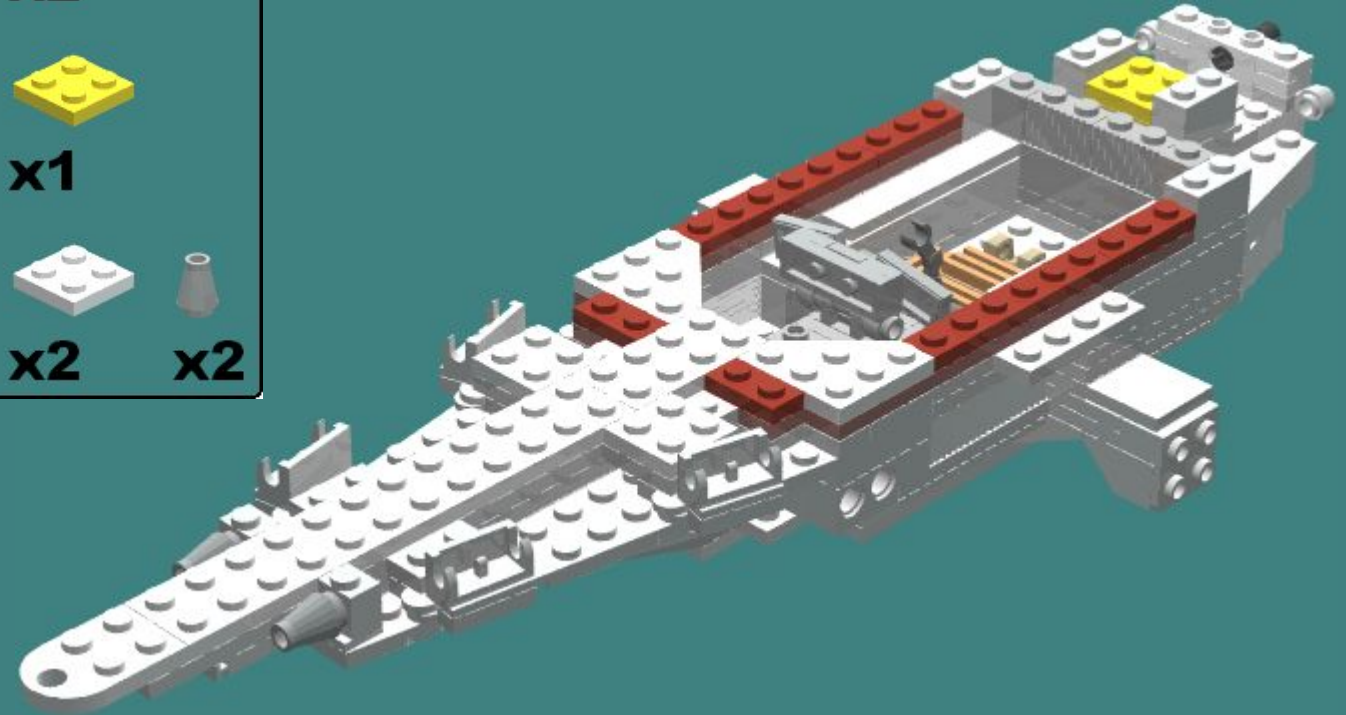

15

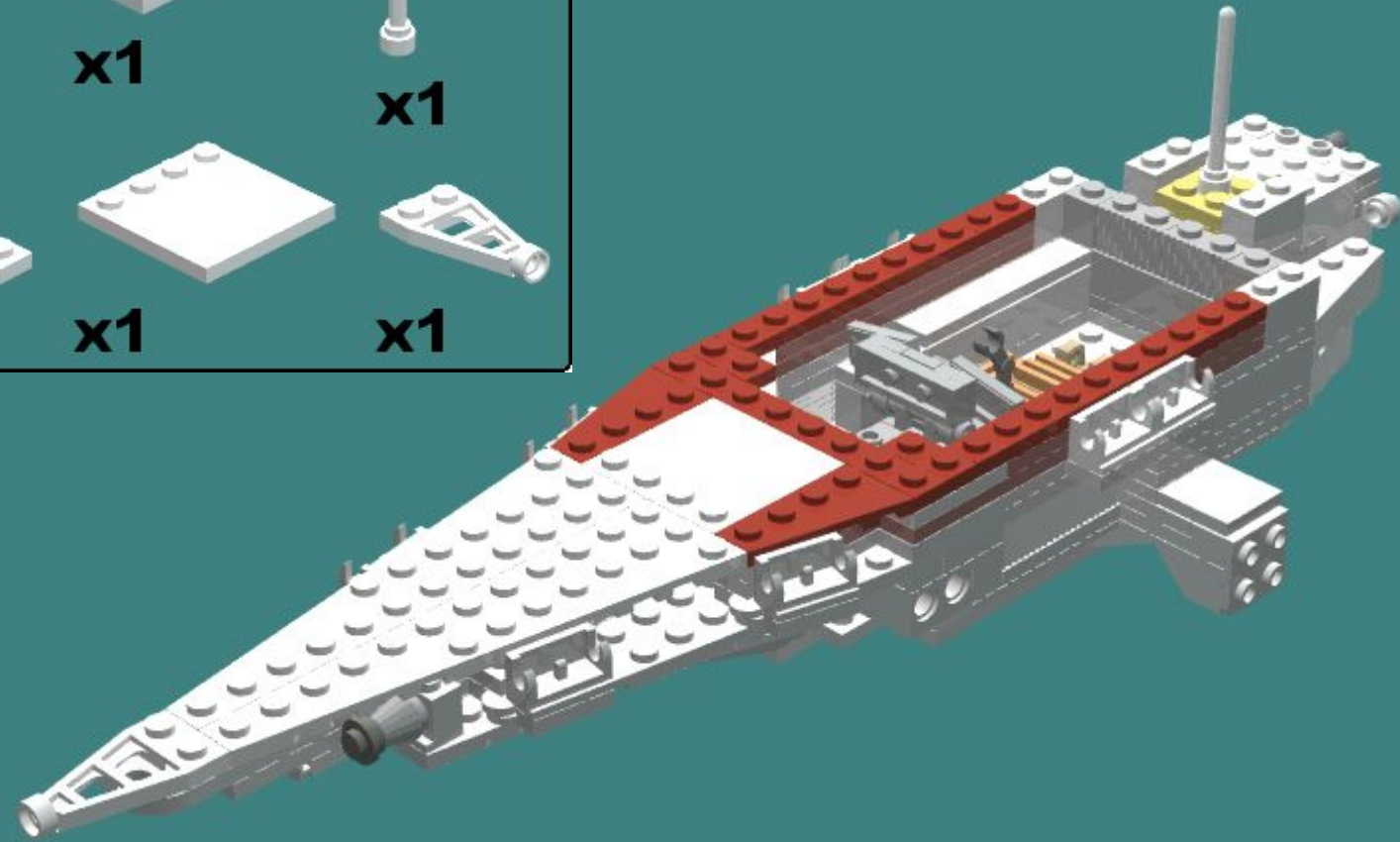
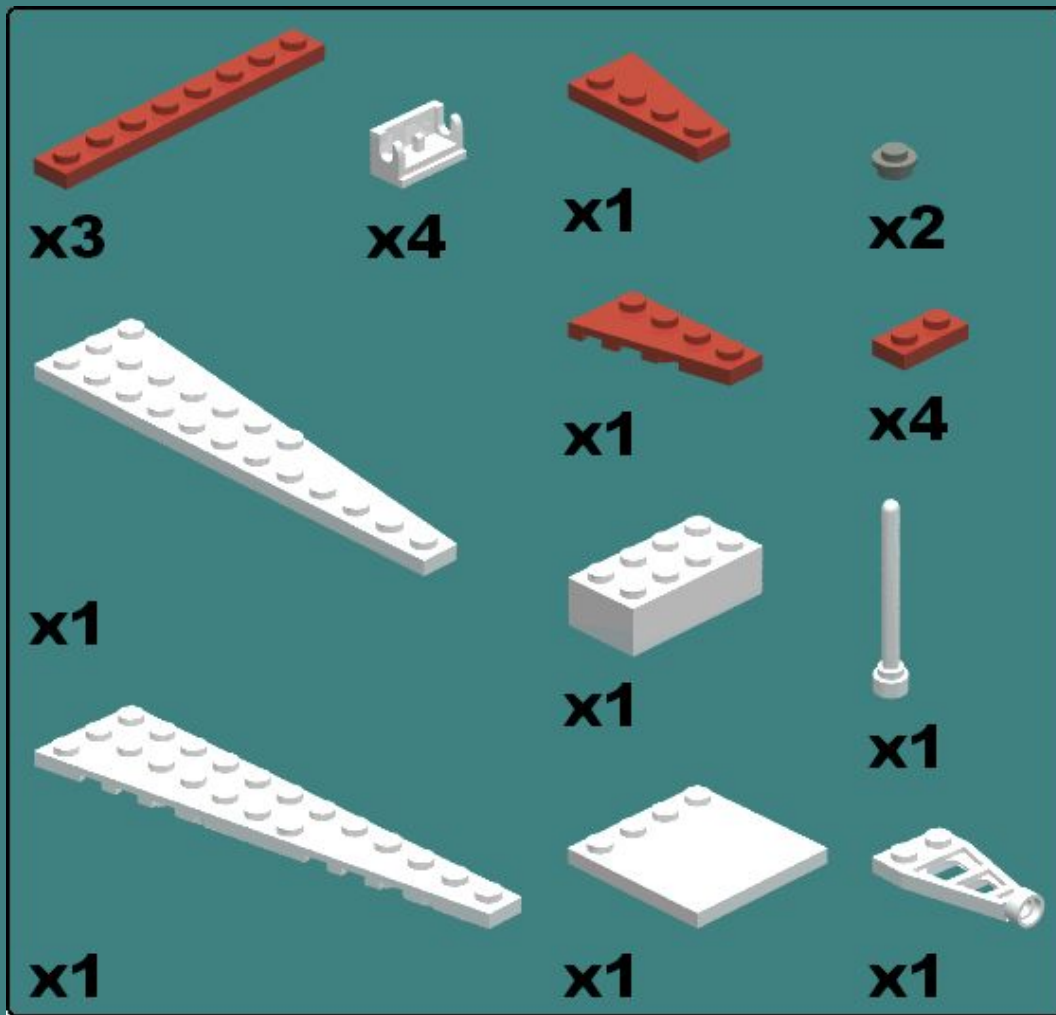

1

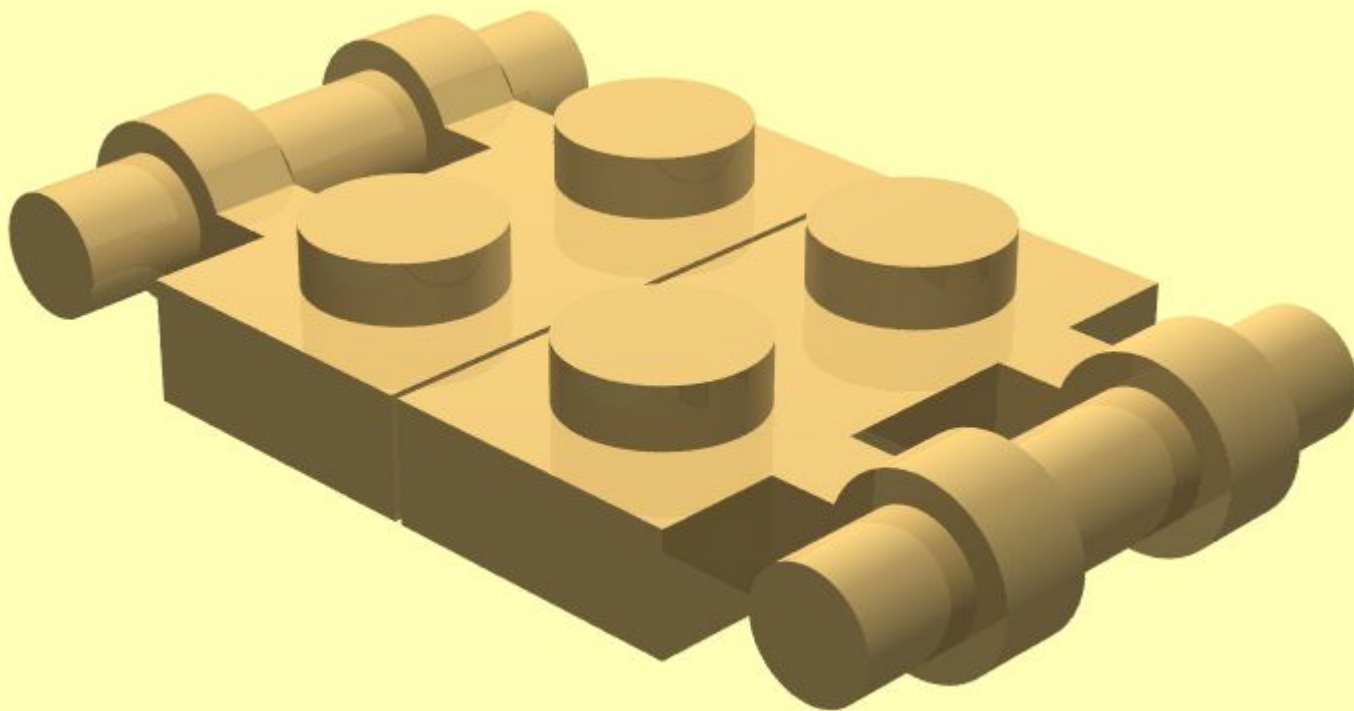

2

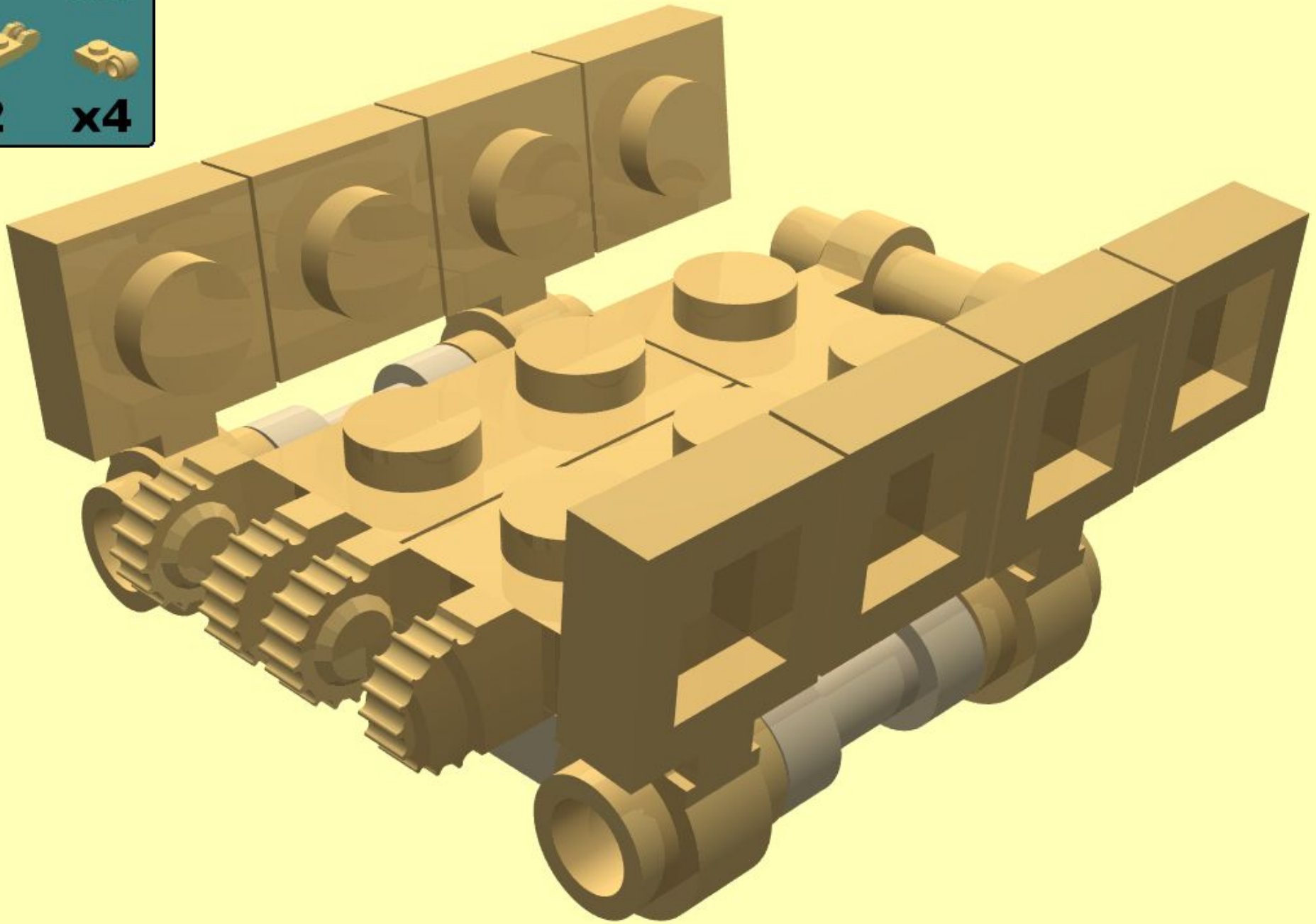
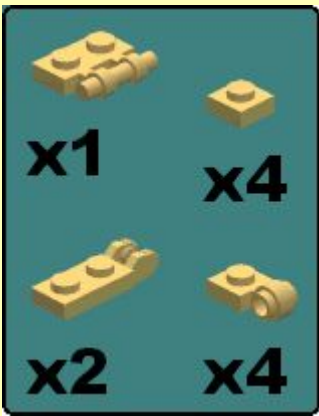

3

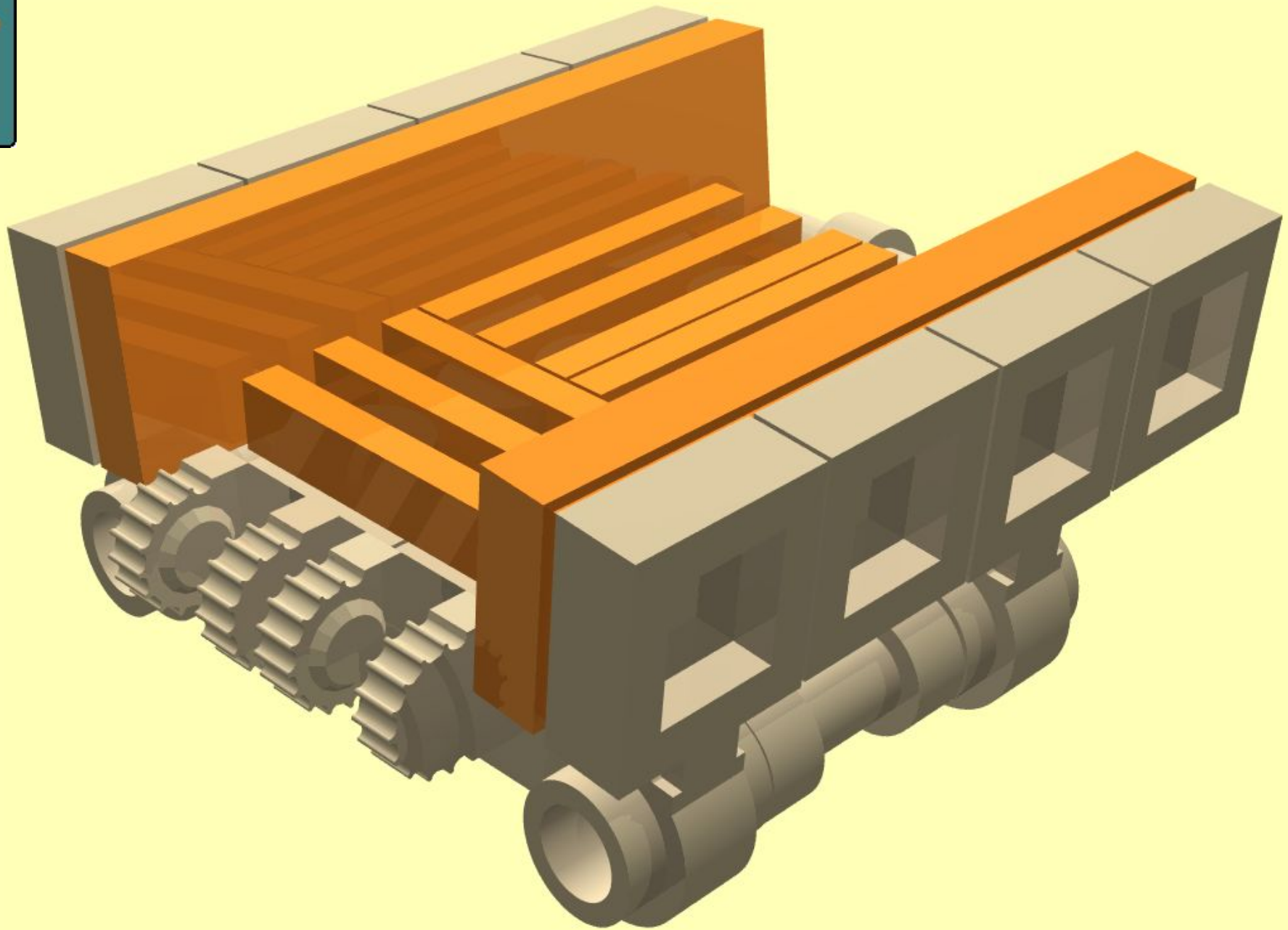

16

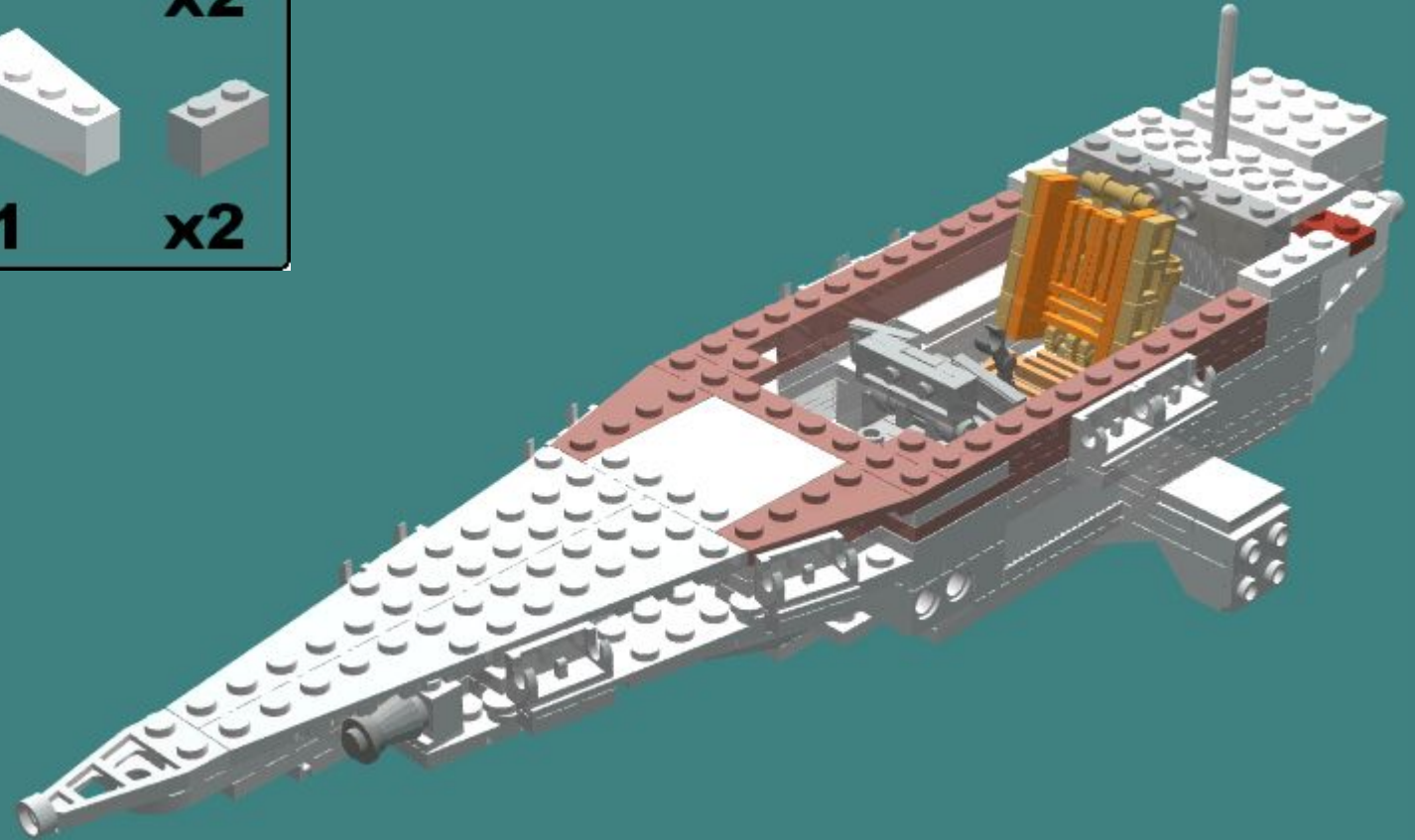
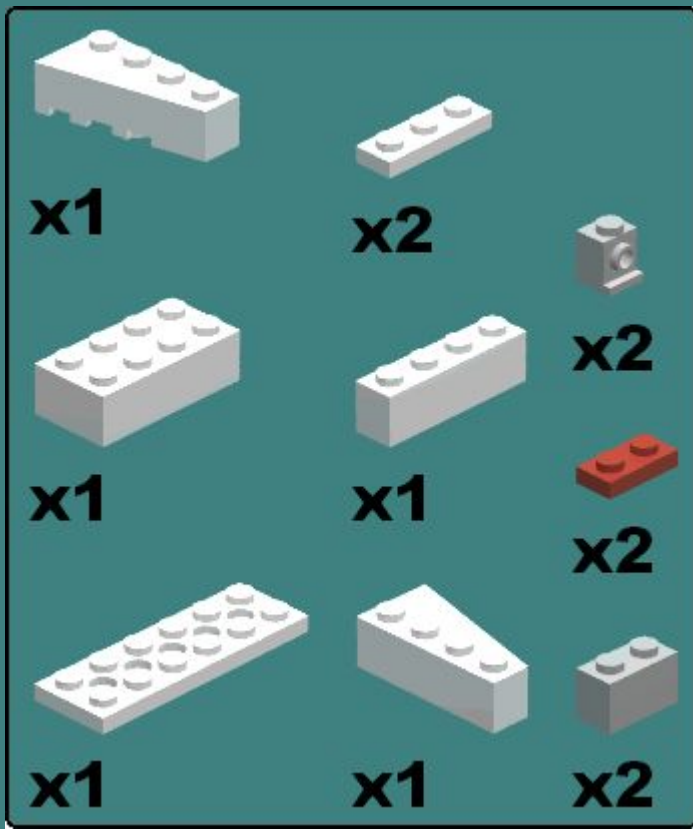

17

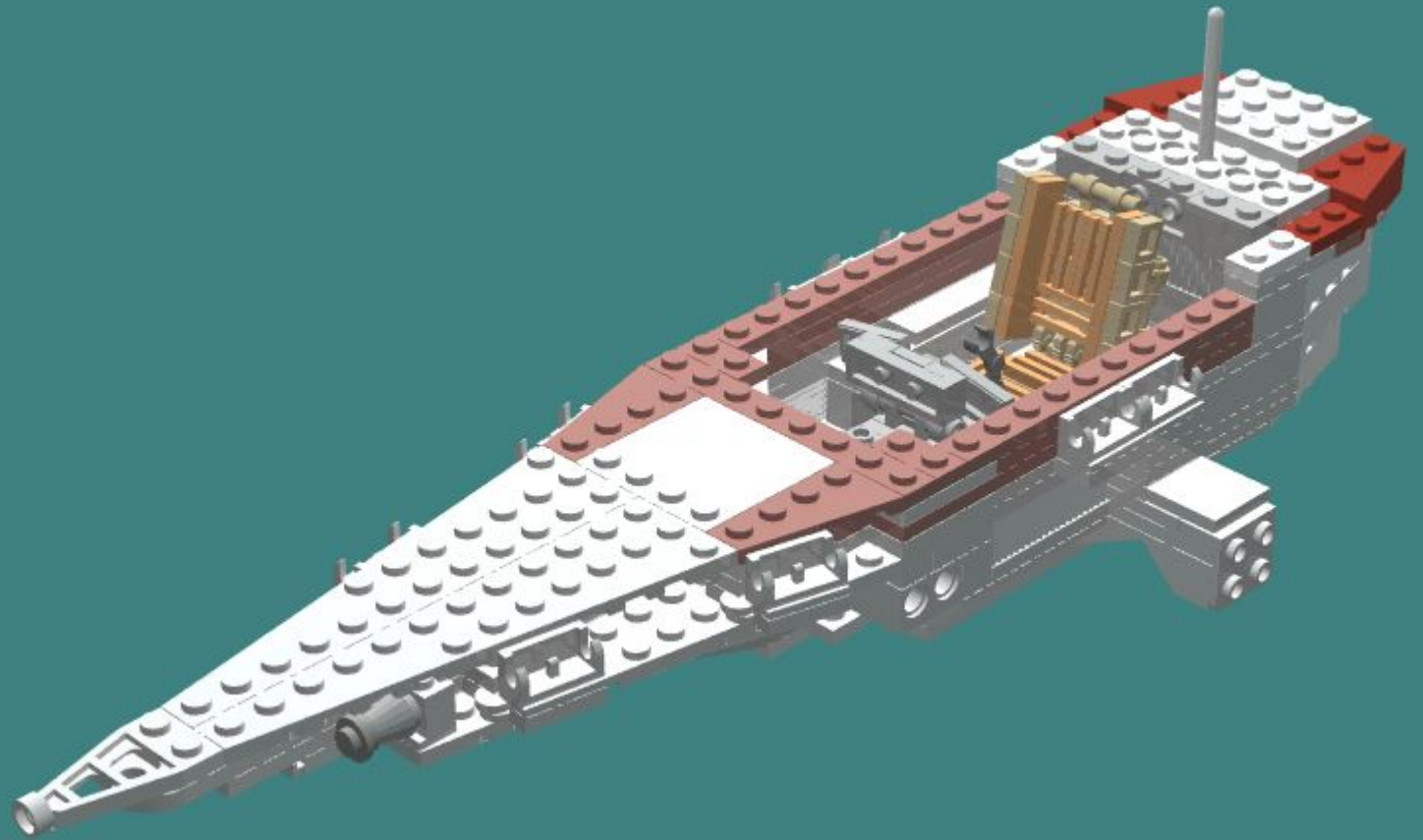
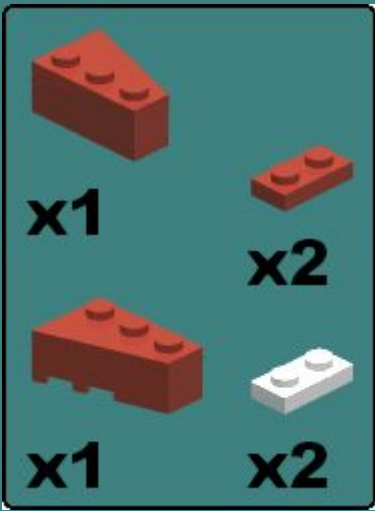

18



x1



x2

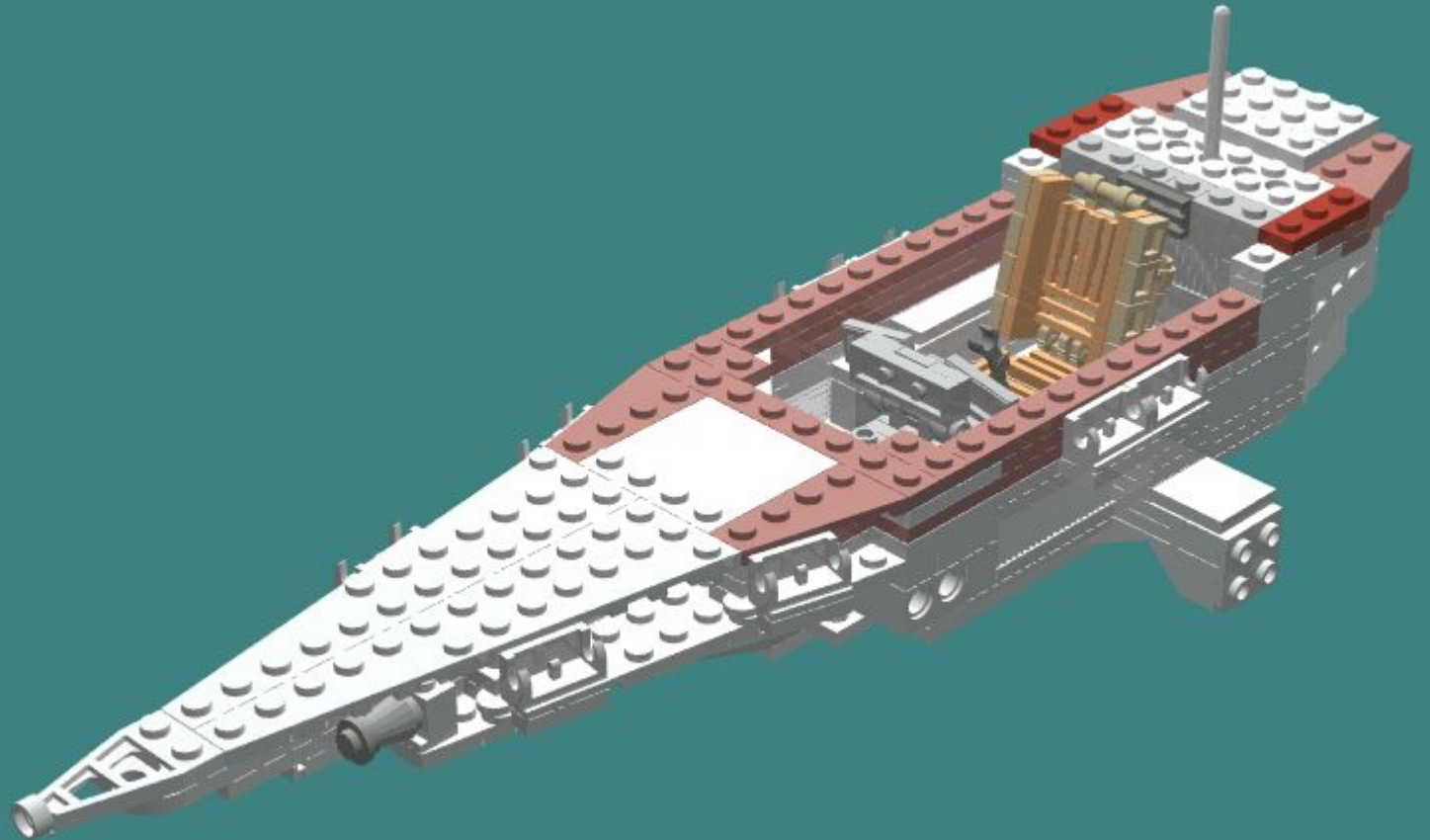

19

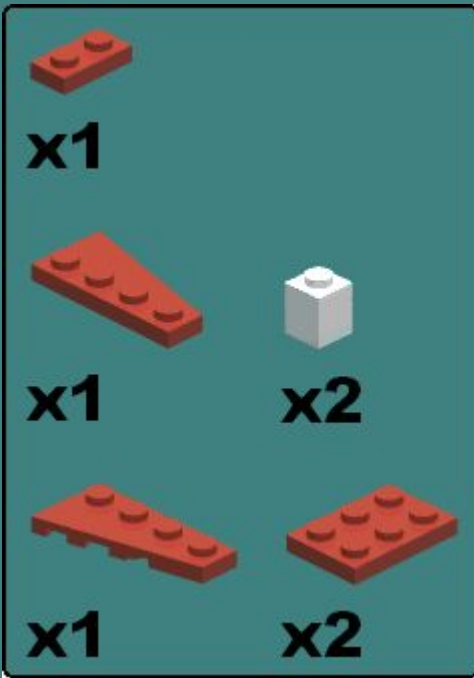

20

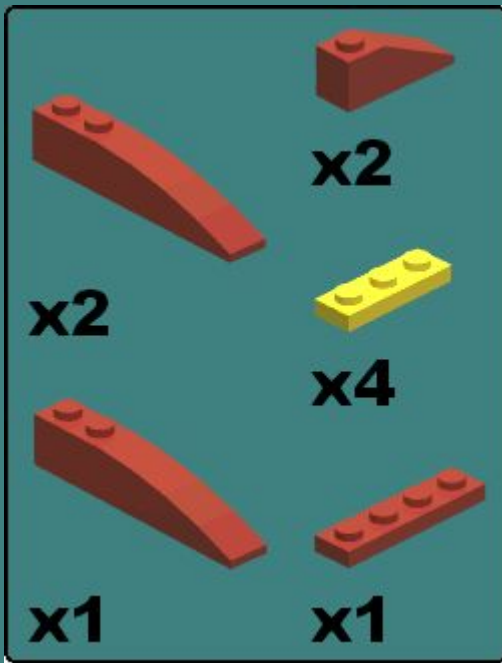



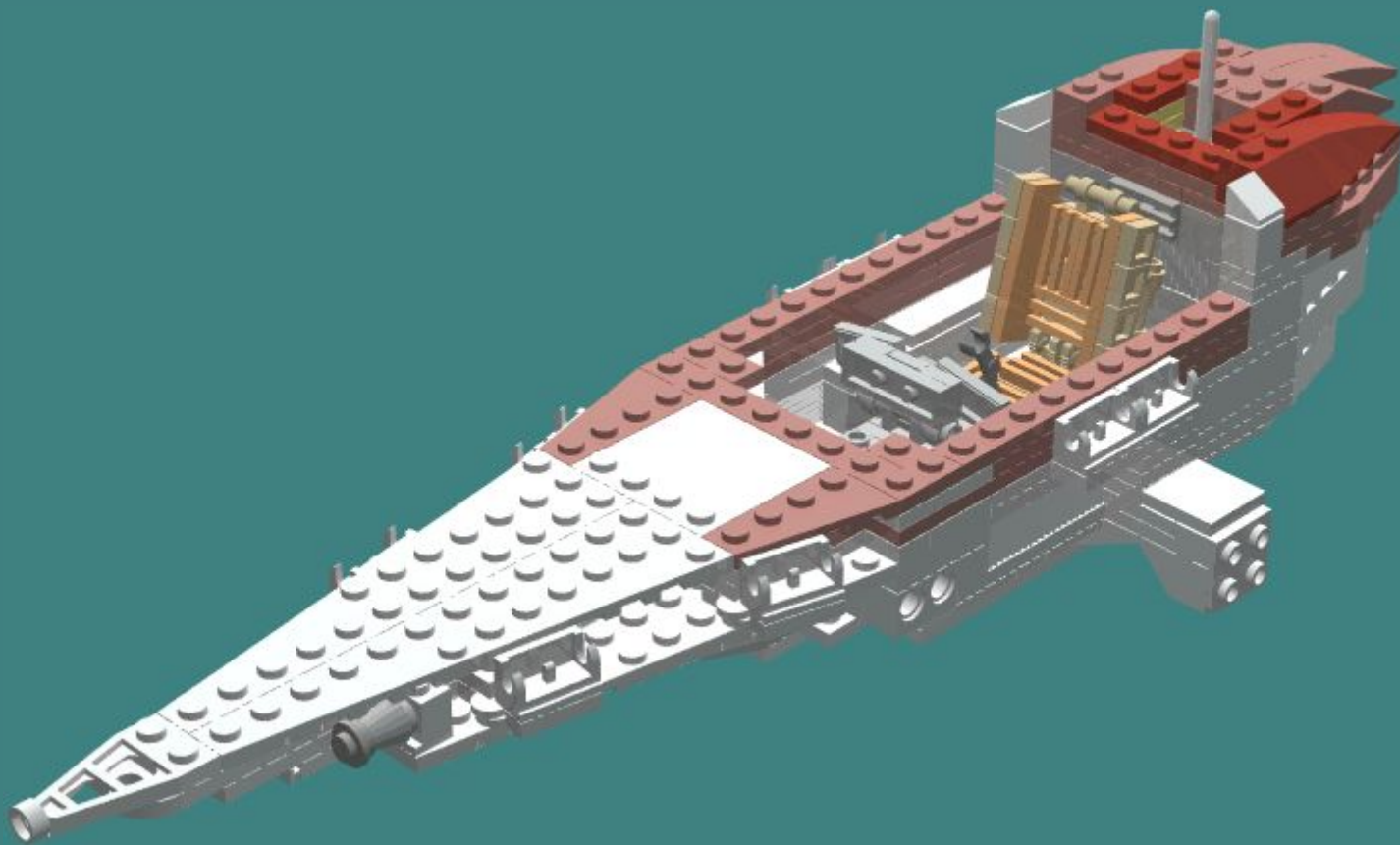
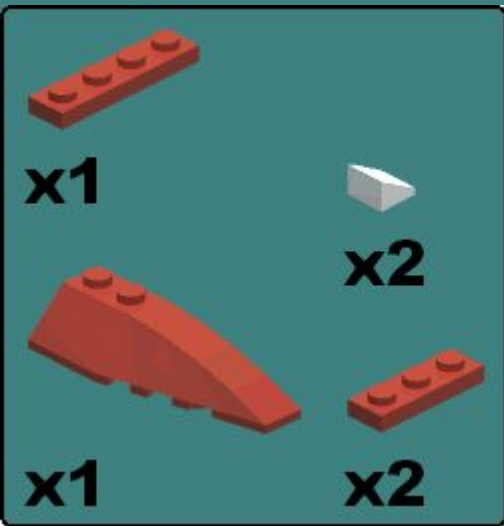

Instructions available for free at:
<http://www.brickshelf.com/cgi-bin/gallery.cgi?m=rgeiger>

Not for sale

21

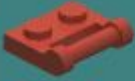

22

	
x2	
	
x2	x1
	
x1	x3

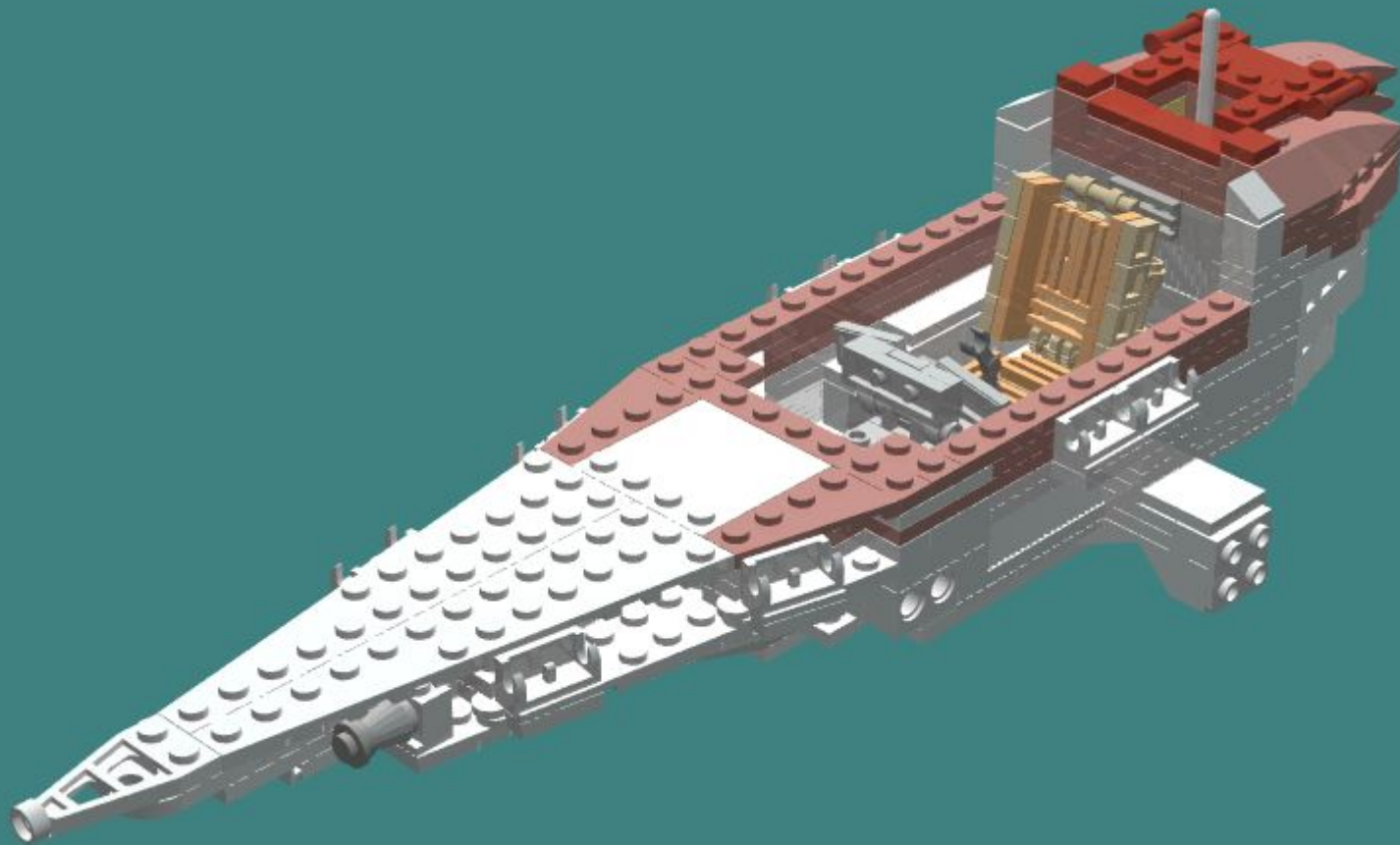

1



x1



x1

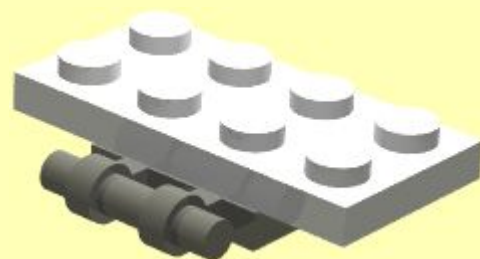

2



x2



x2

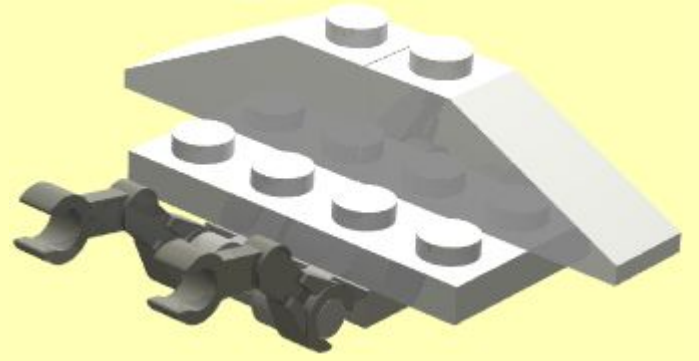

3

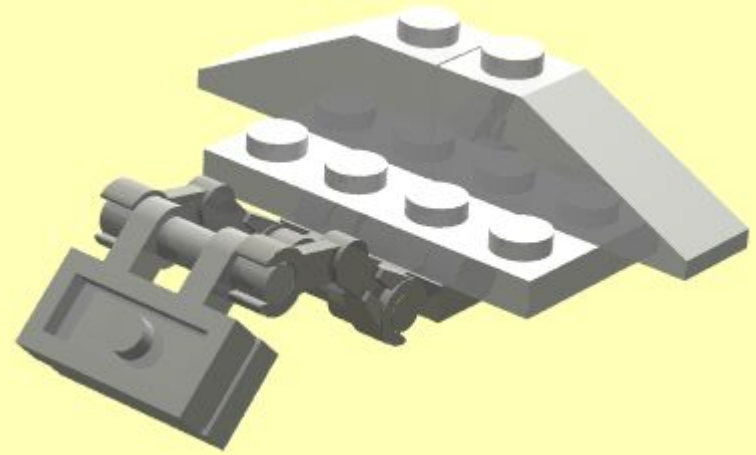

4

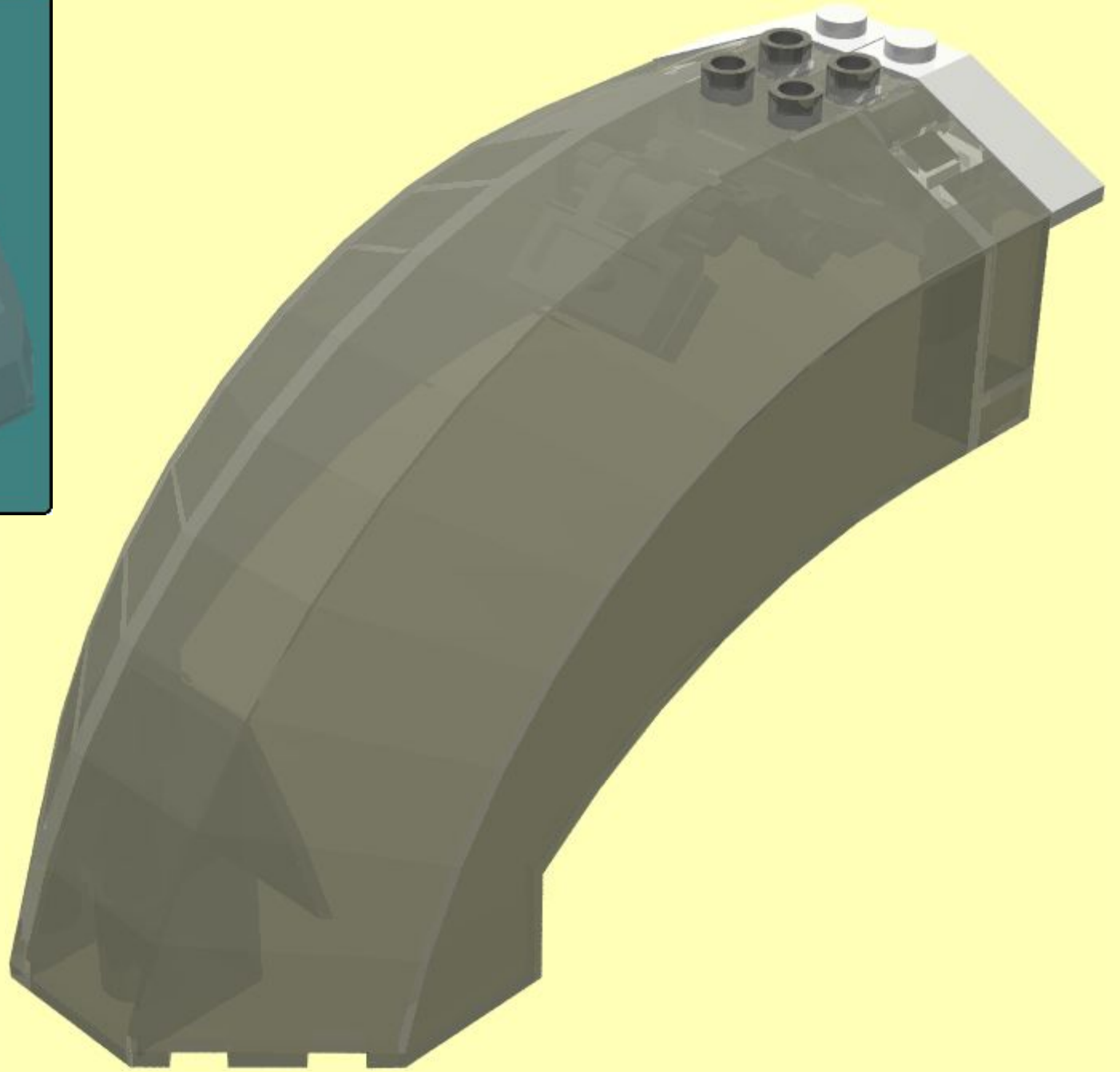

5



x2



x2

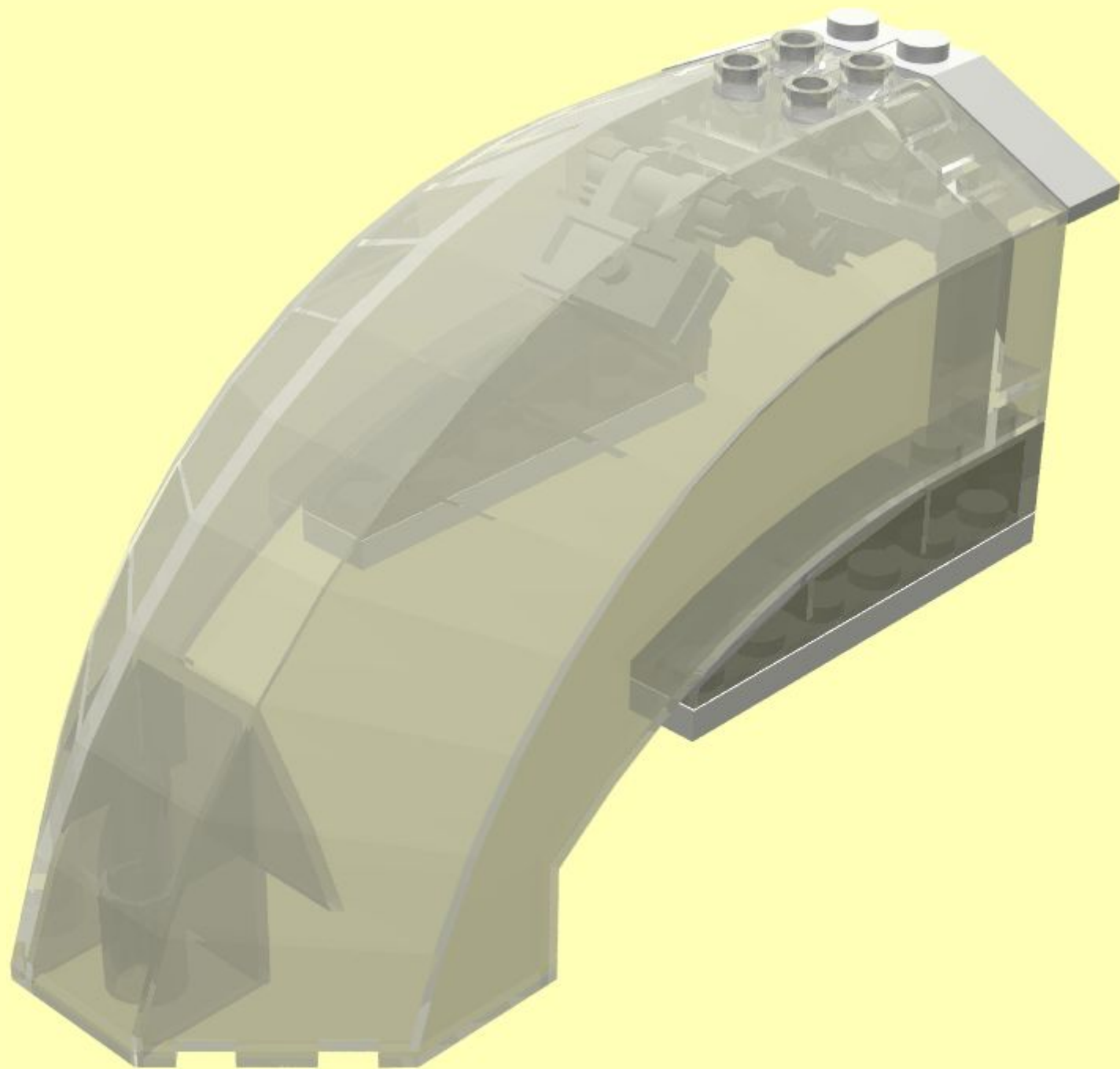

23

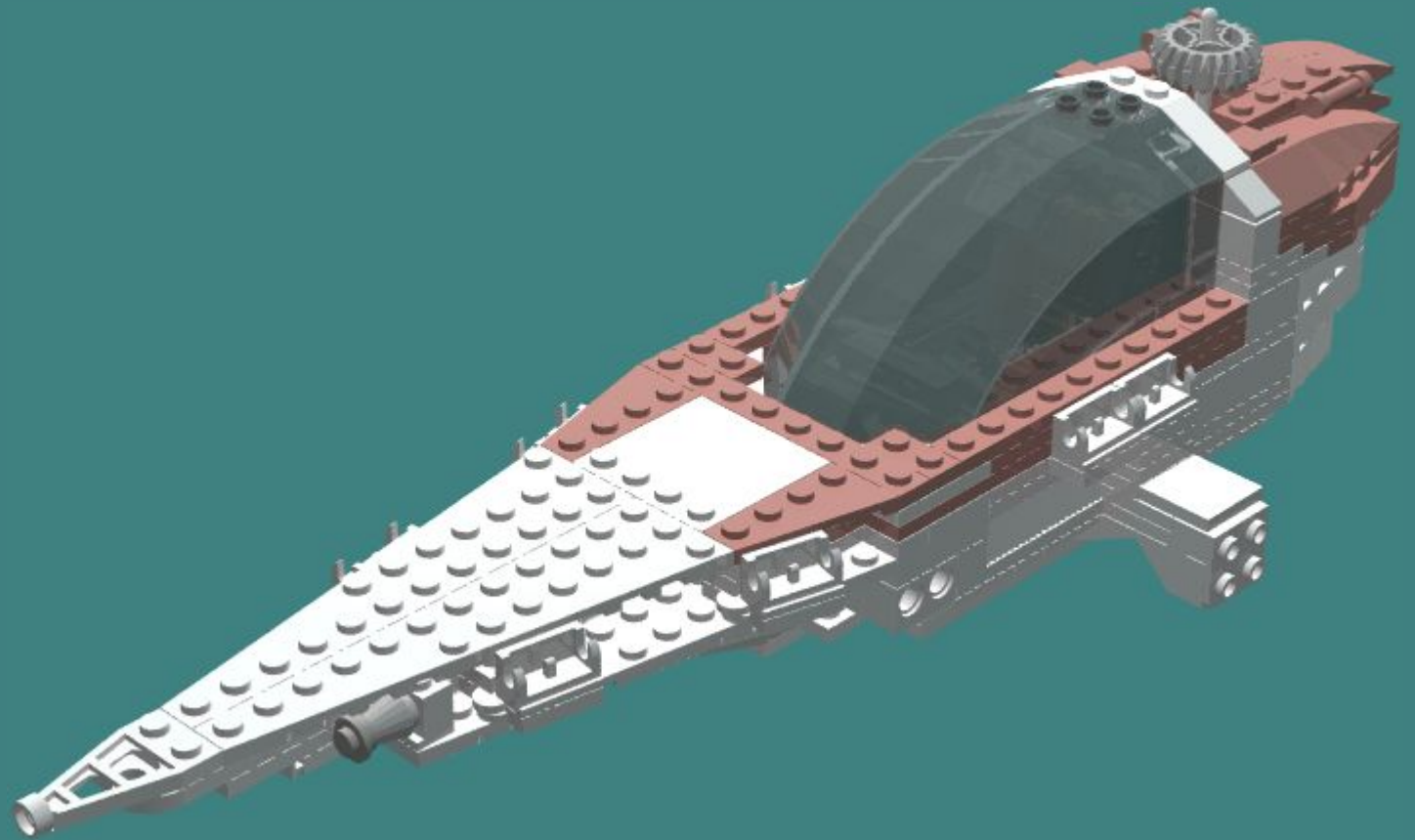

1

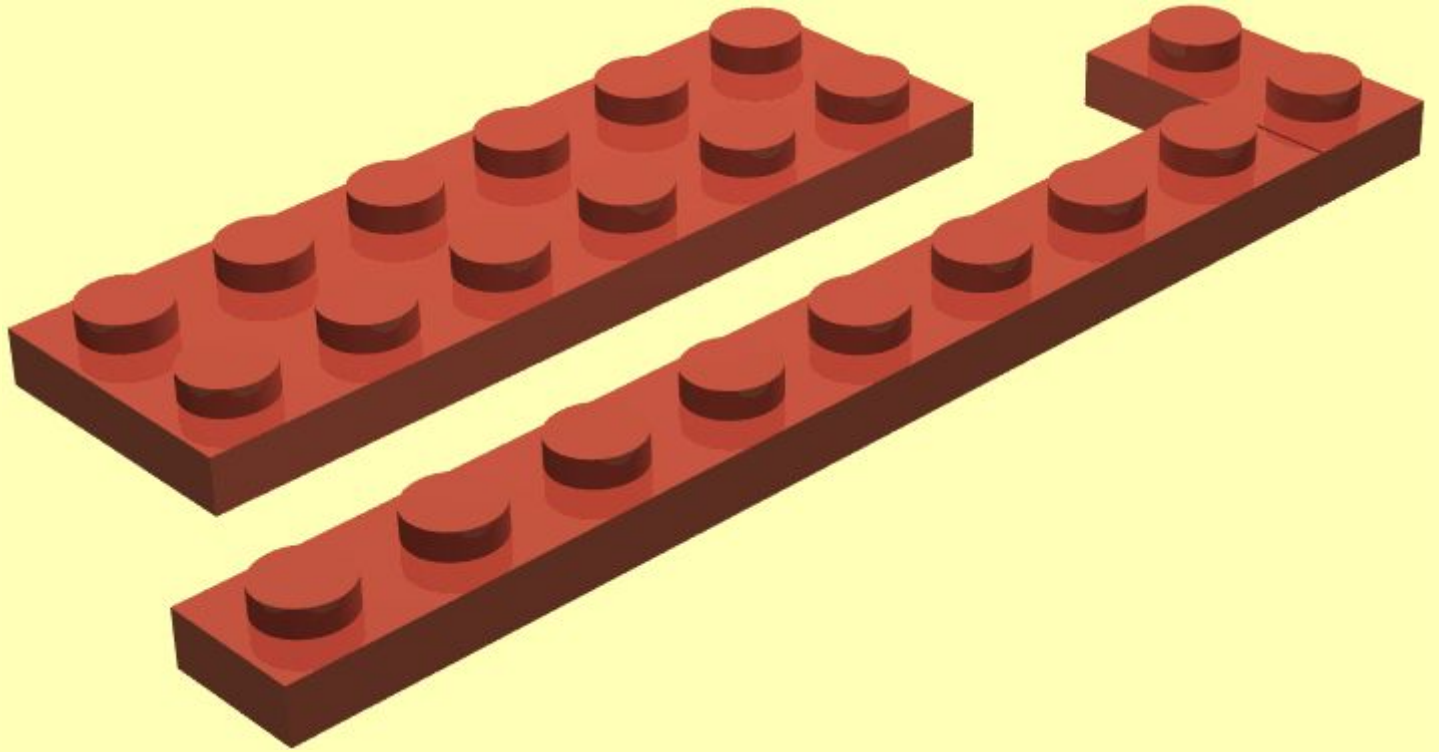
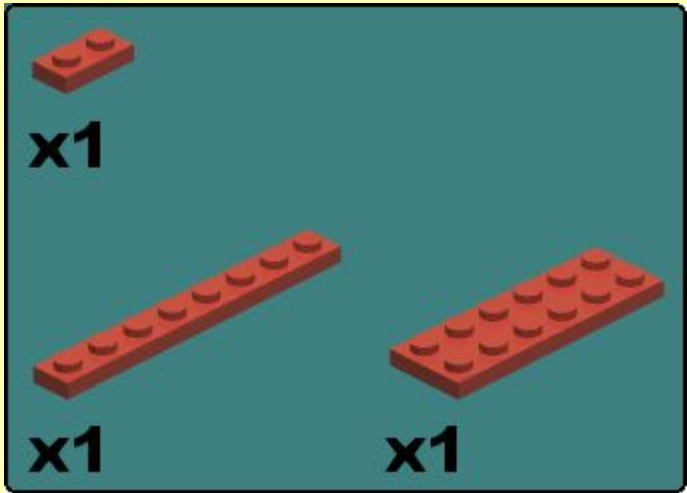

2

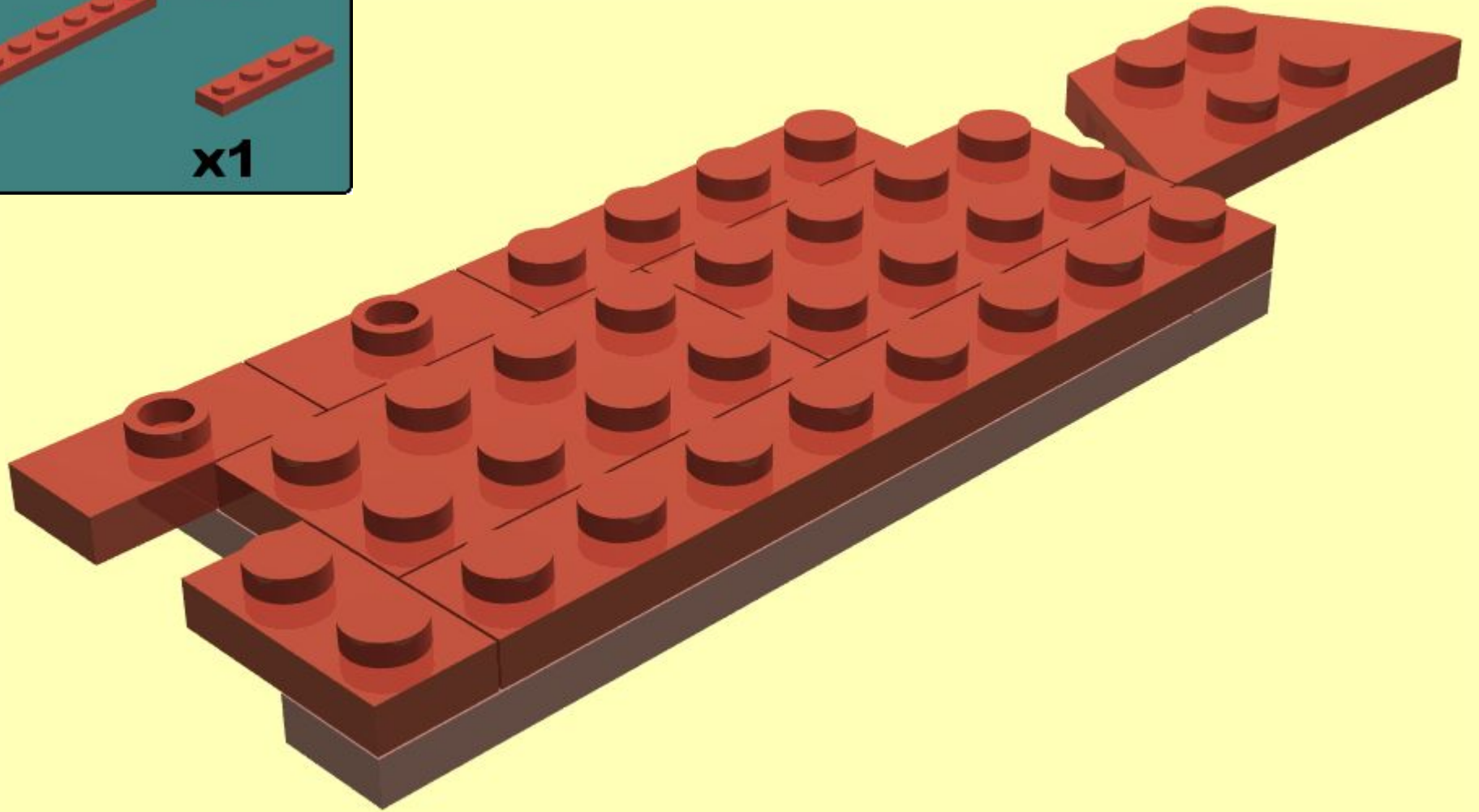
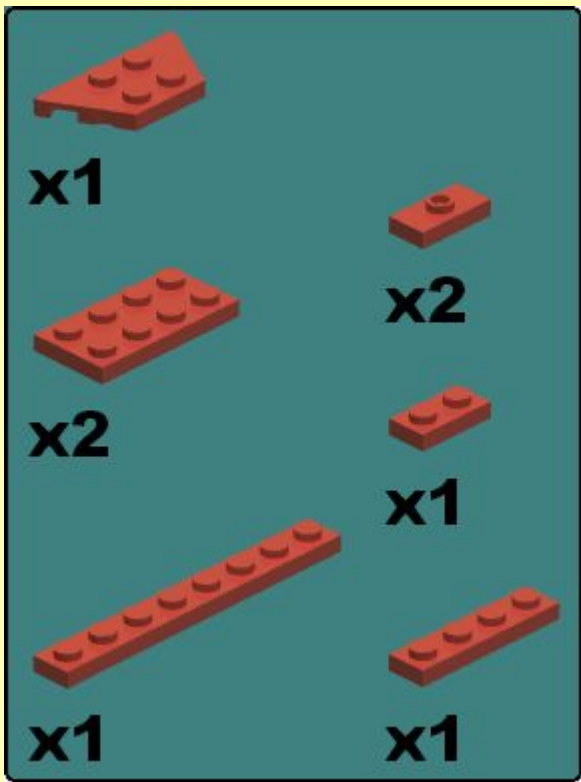

3

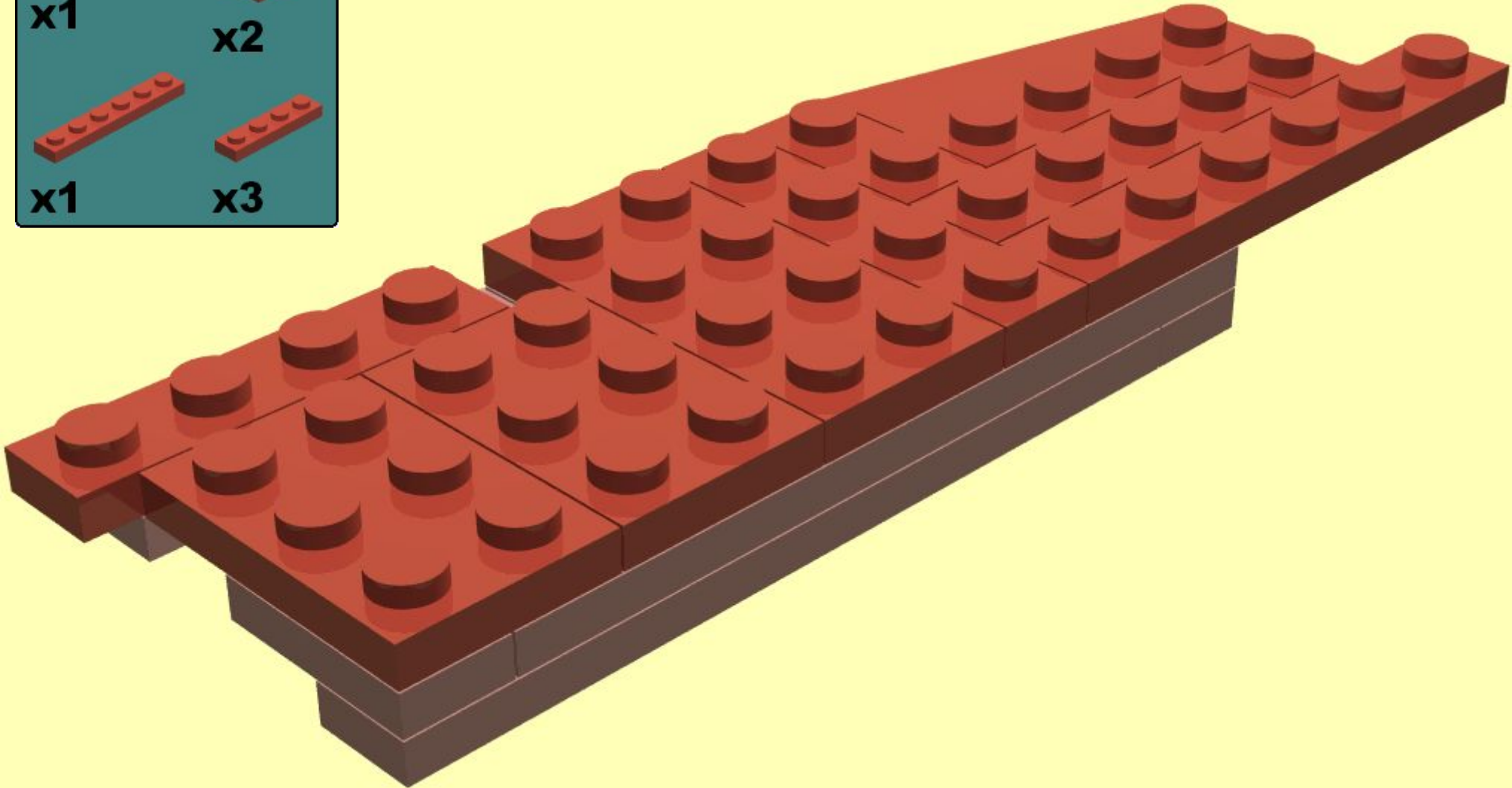
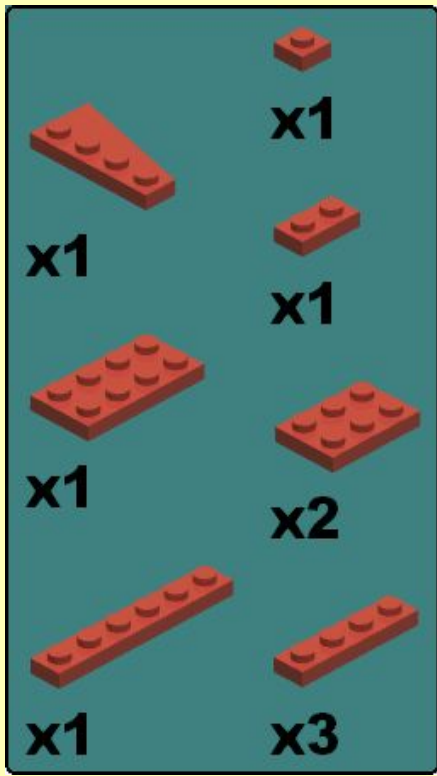

4

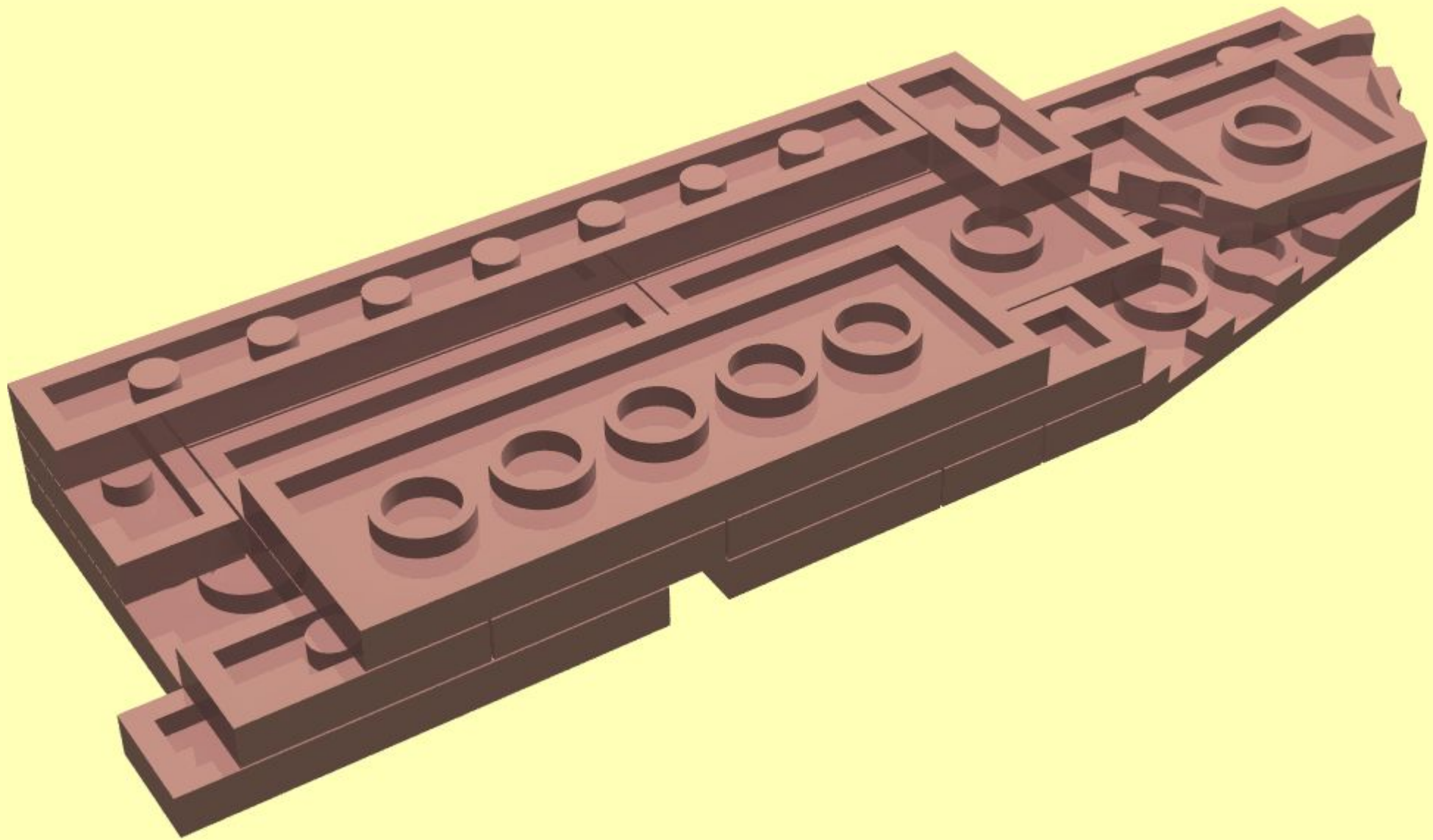

5

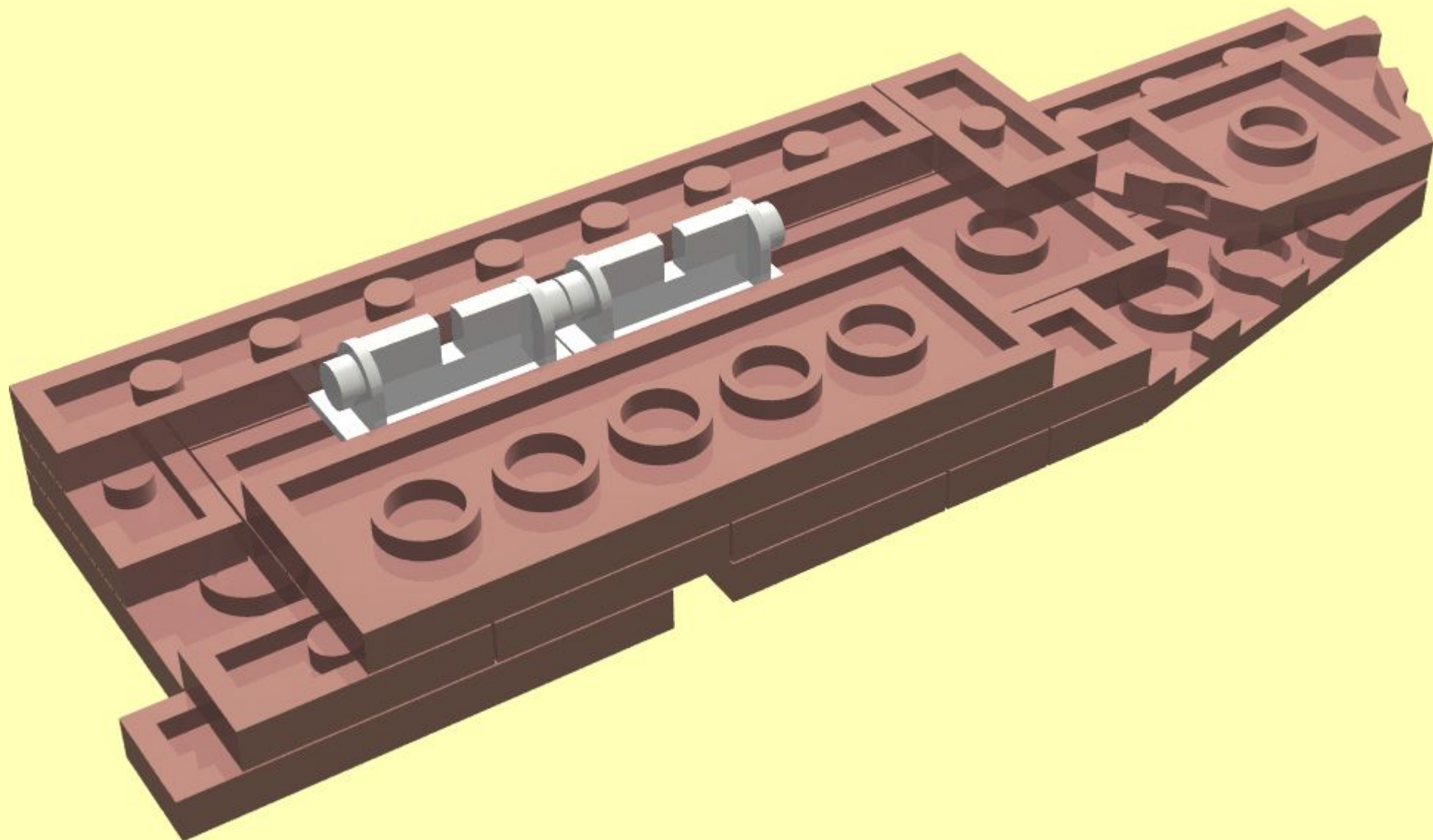

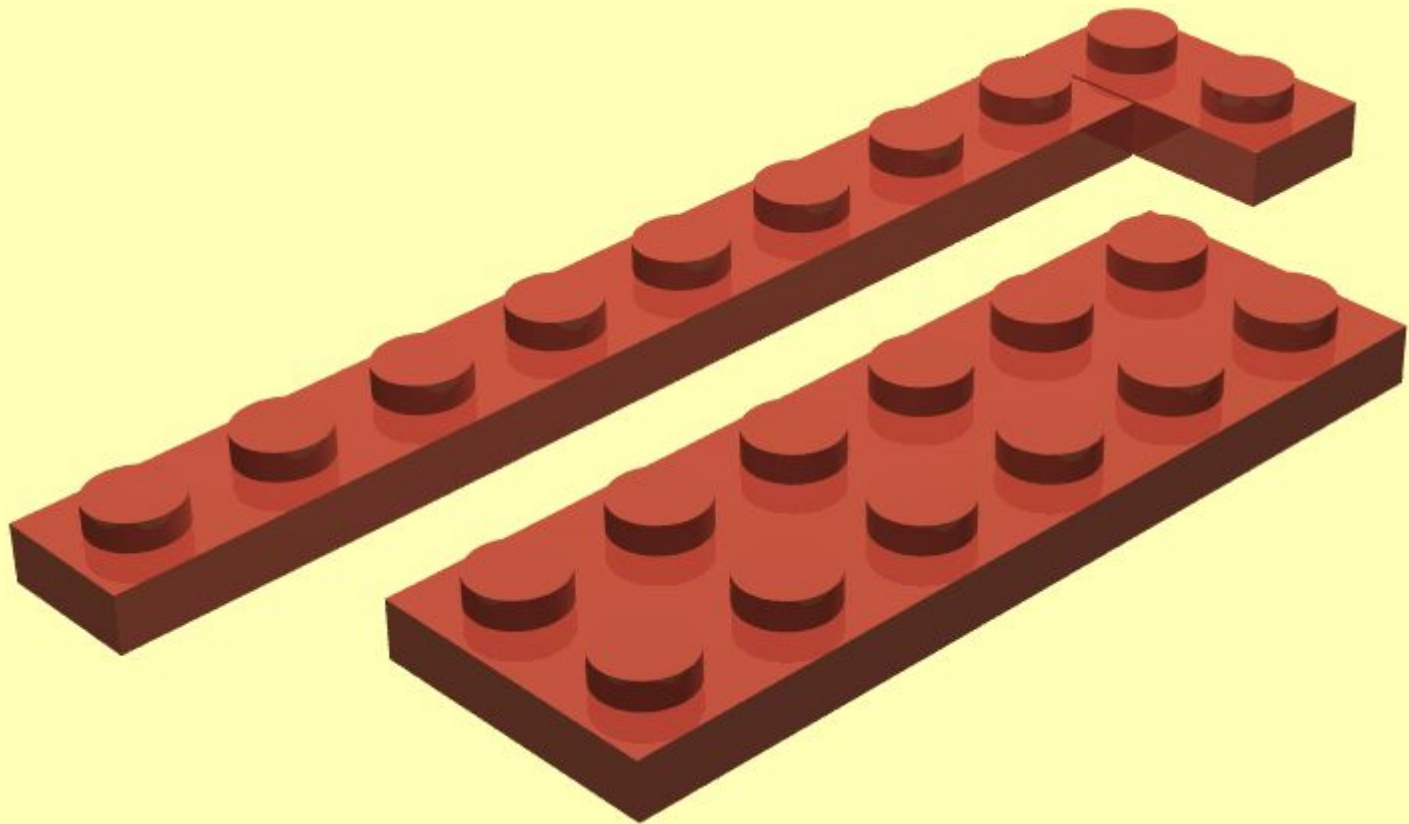
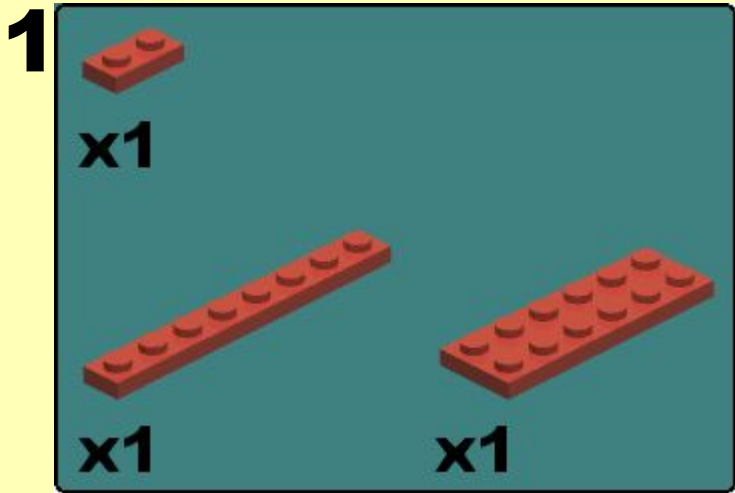

2

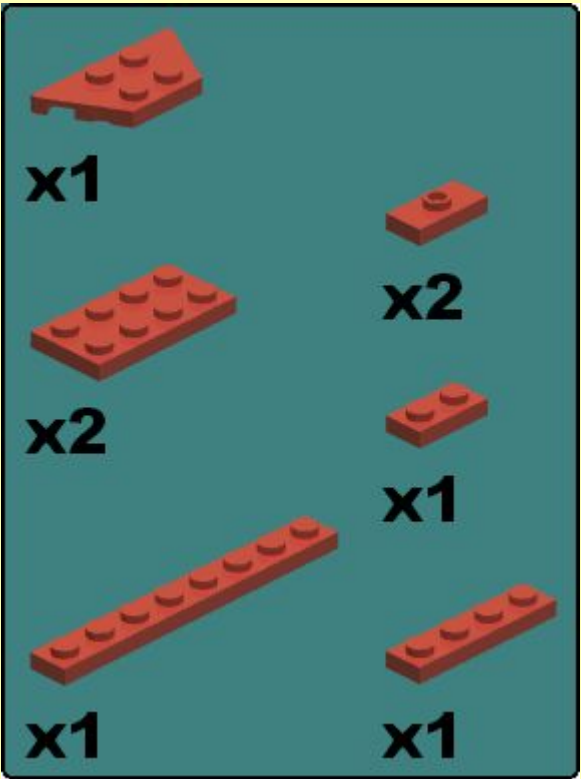

A parts list for step 2, displayed on a teal background. It includes the following items:

- 1 x 1-3 red Technic plate with 3 studs (top left)
- 1 x 1-5 red Technic plate with 5 studs (middle left)
- 1 x 1-7 red Technic plate with 7 studs (bottom left)
- 2 x 1-1 red Technic plate with 1 stud (top right)
- 2 x 1-2 red Technic plate with 2 studs (middle right)
- 1 x 1-2 red Technic plate with 2 studs (bottom right)
- 1 x 1-4 red Technic plate with 4 studs (bottom right)

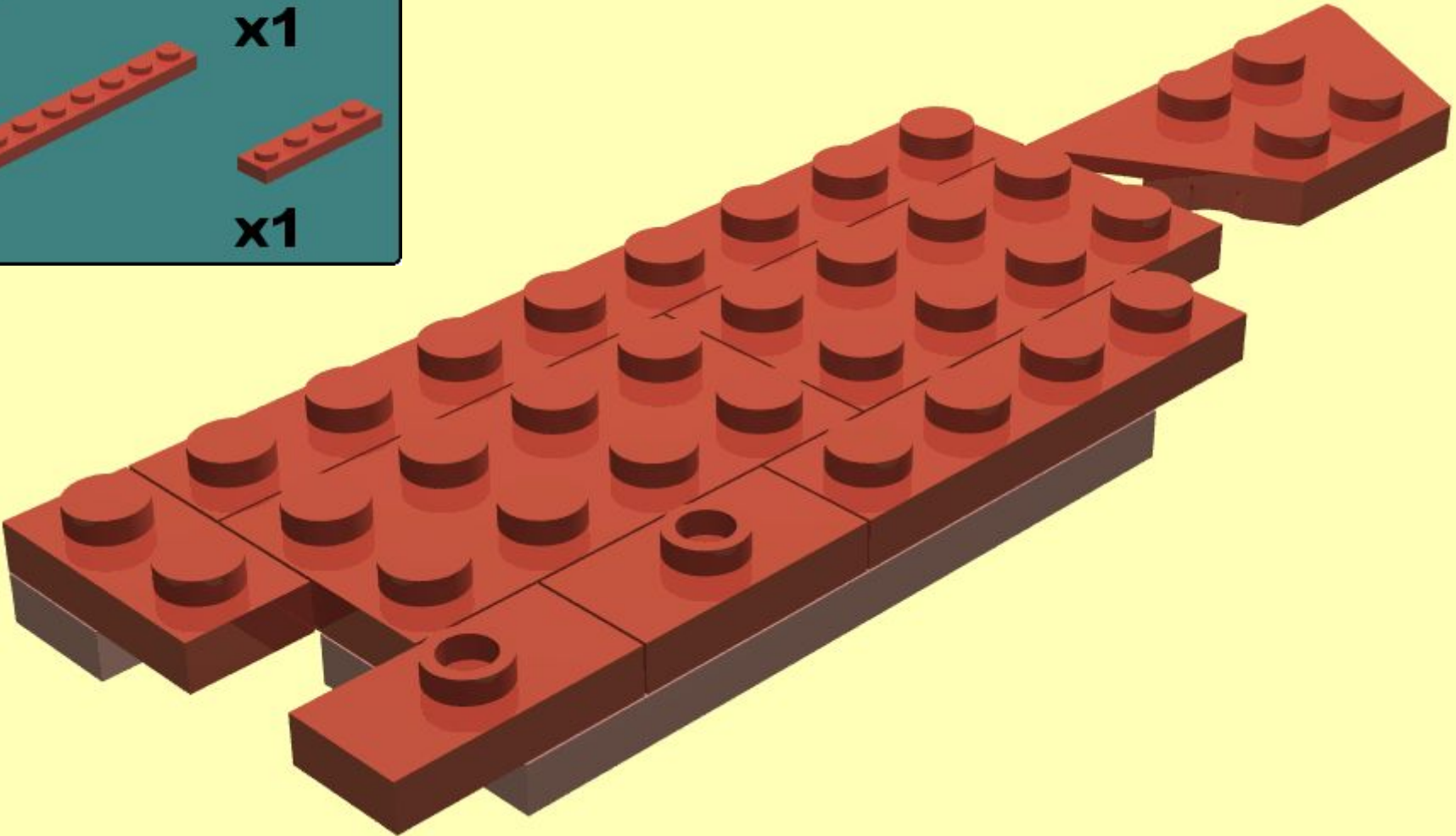

3

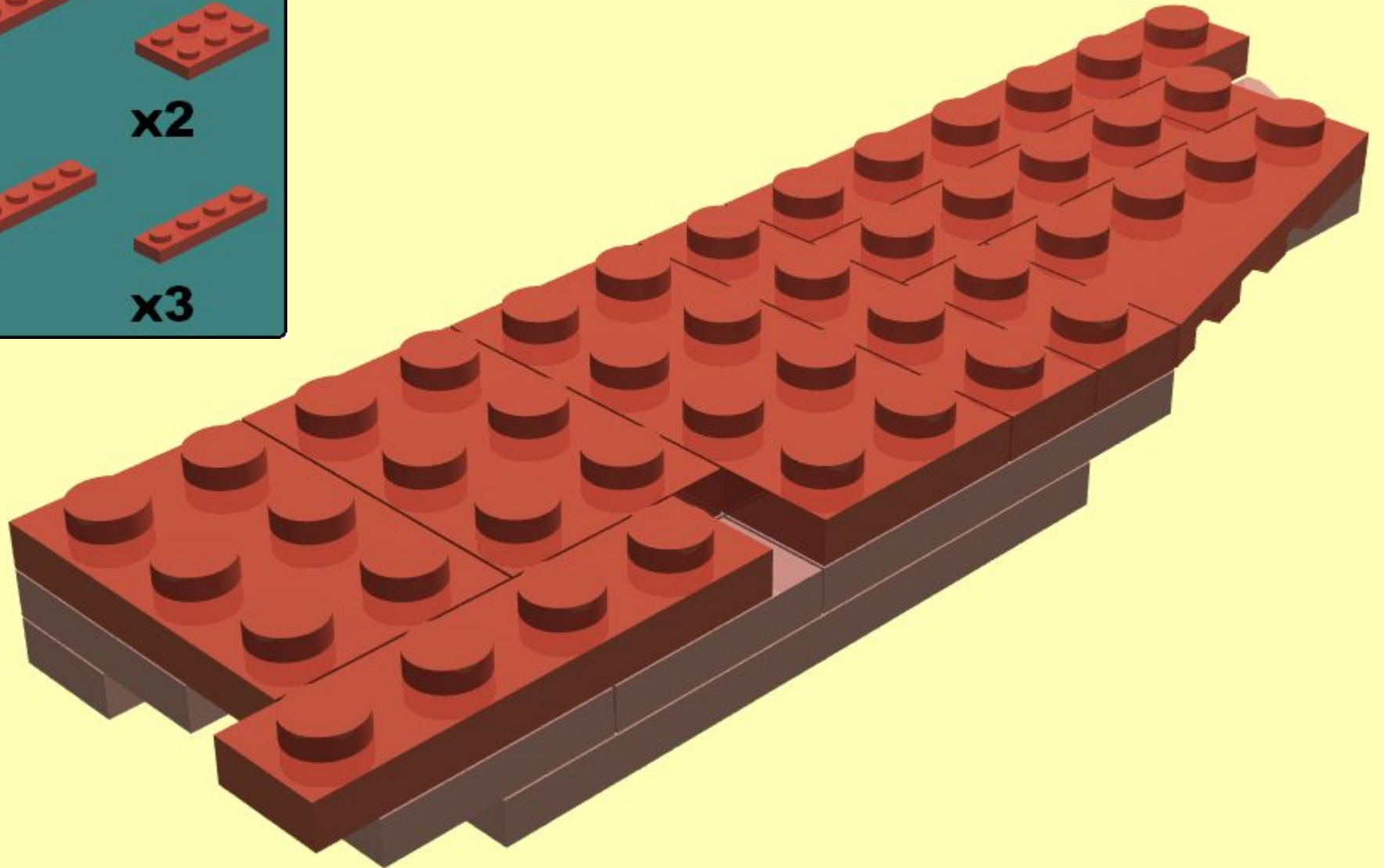
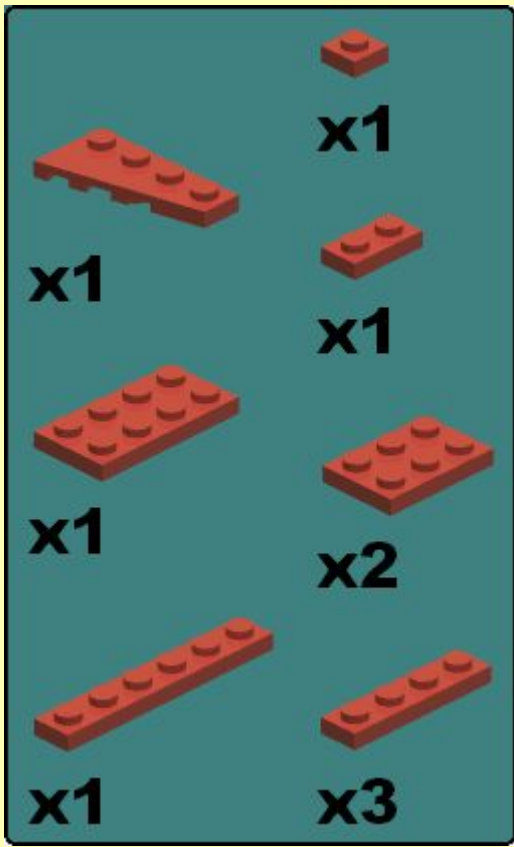

4

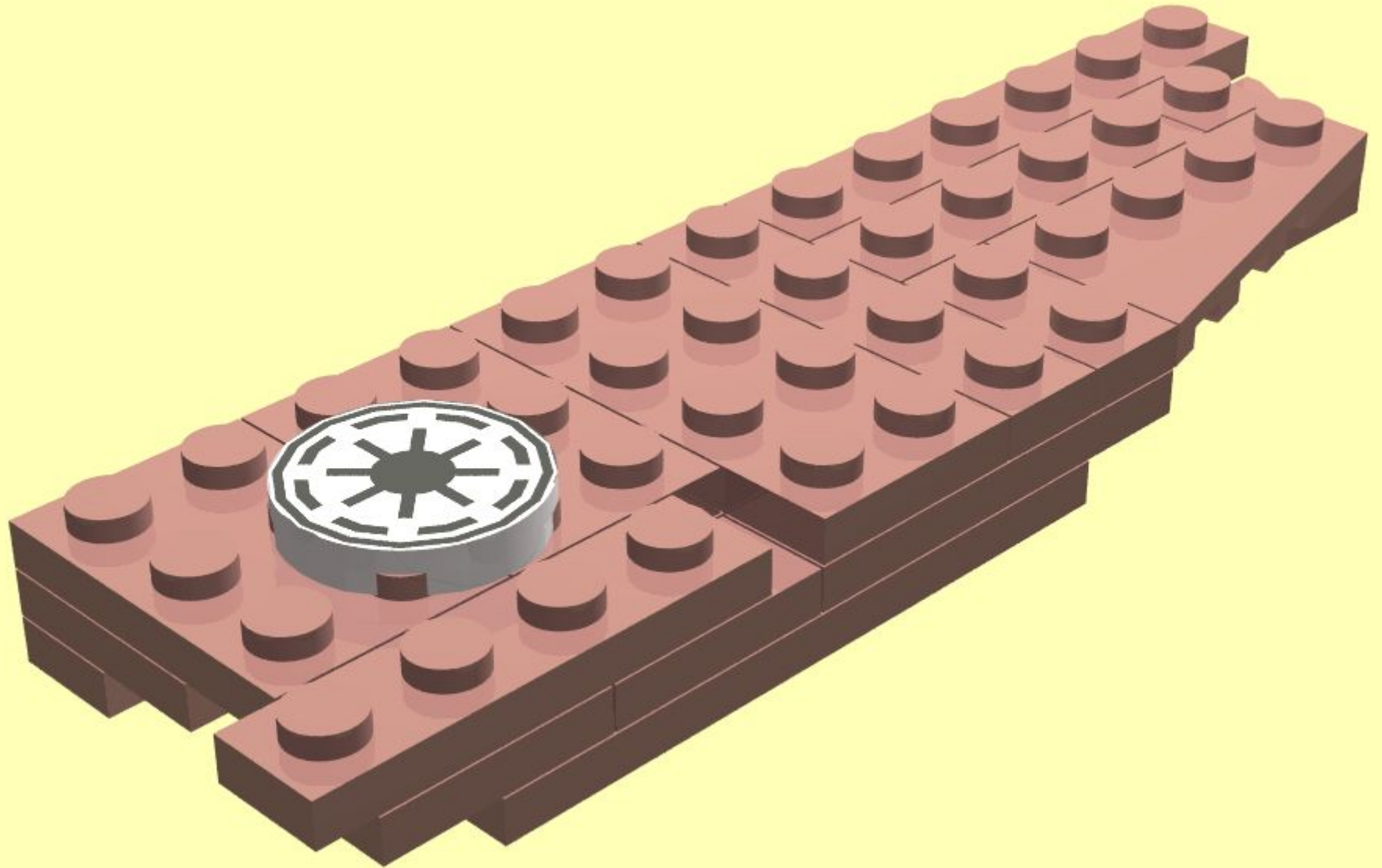

5

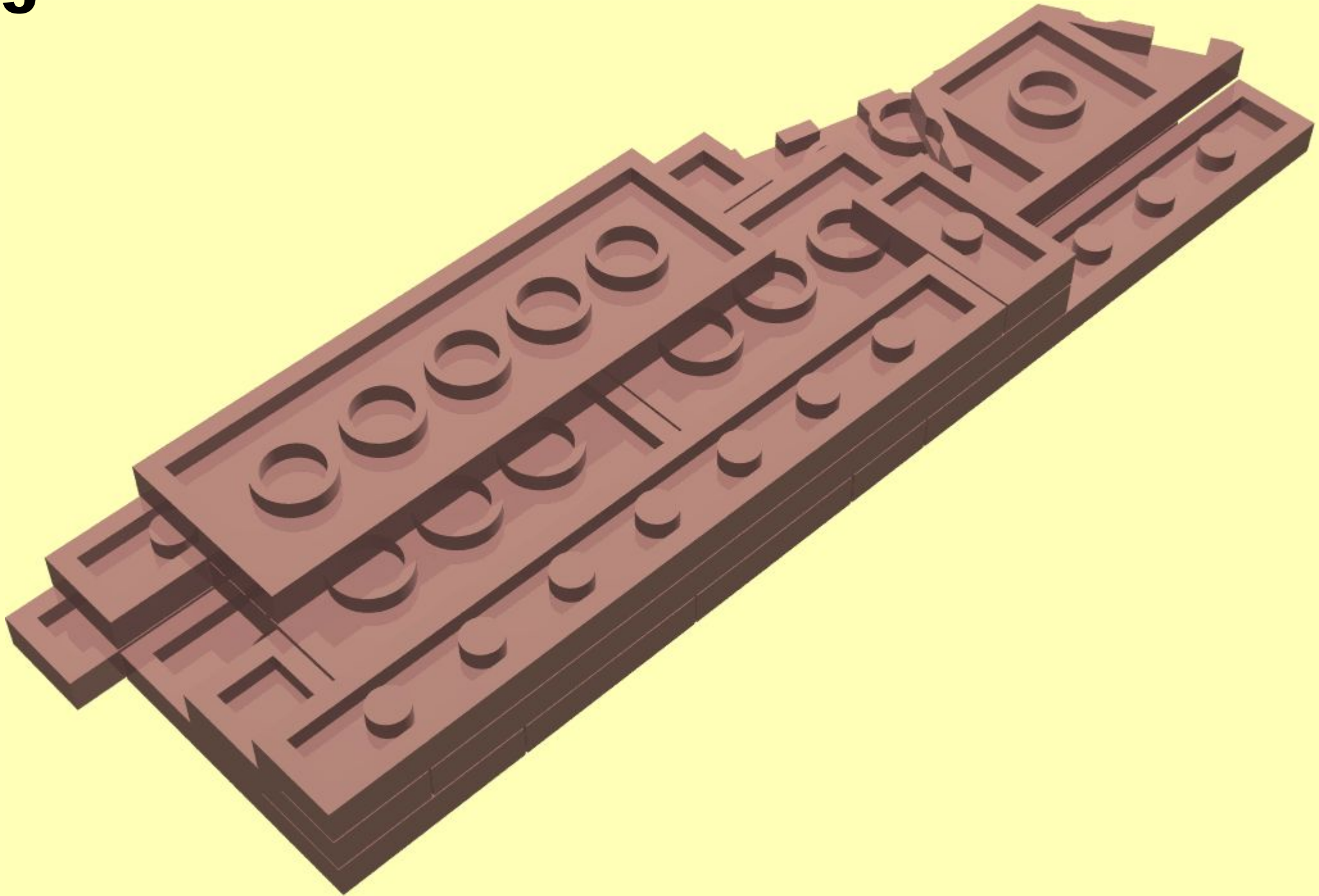

6

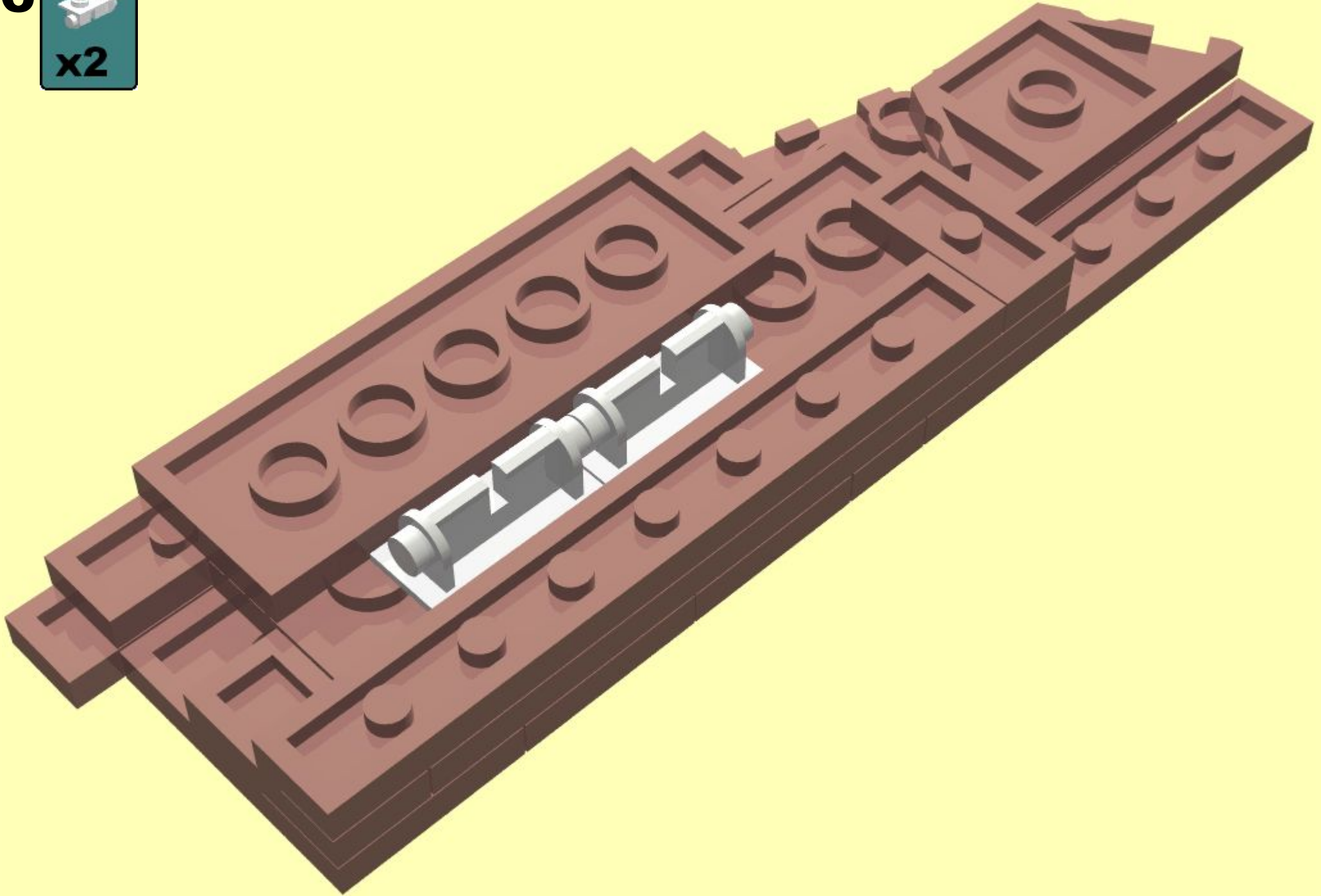

24

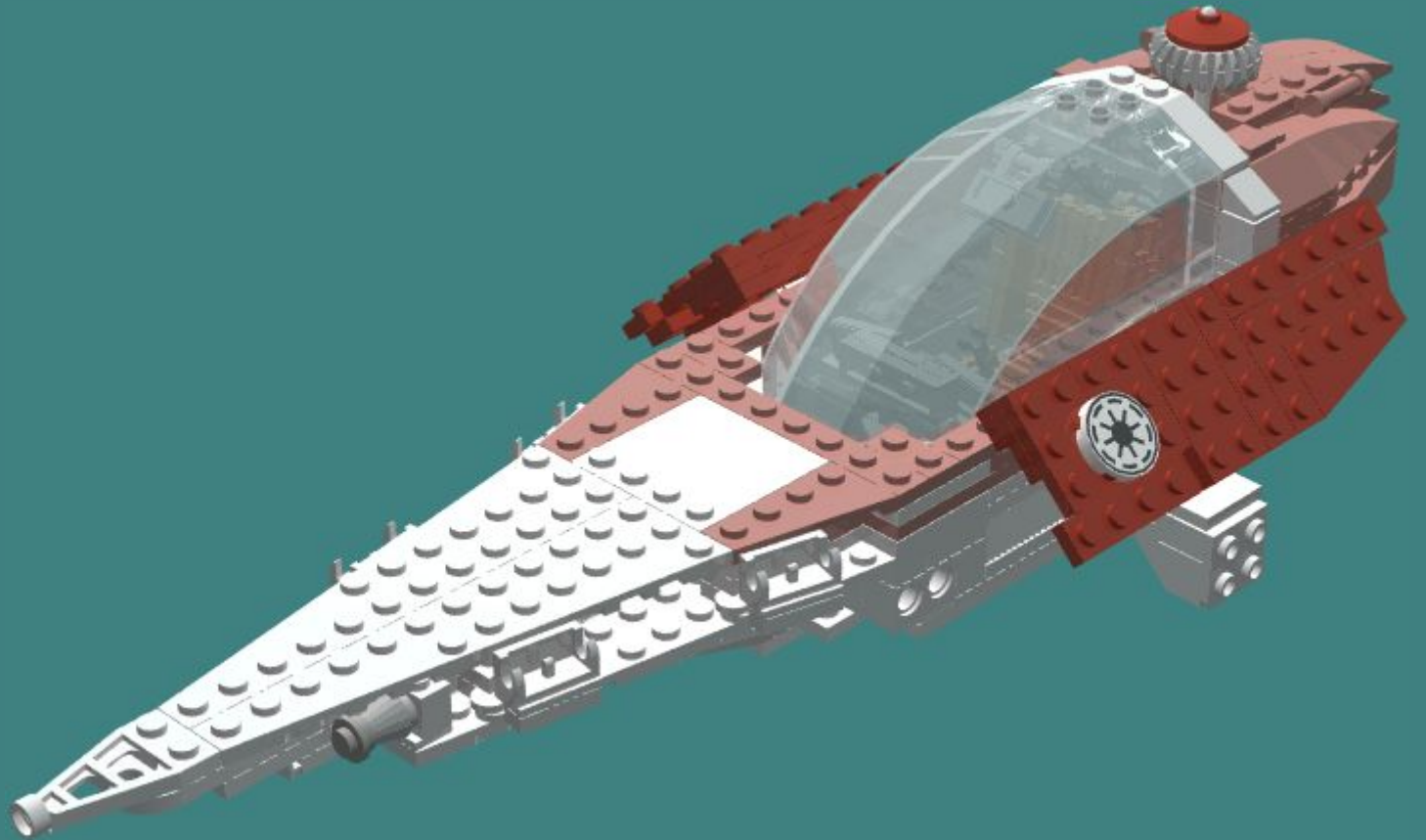

25

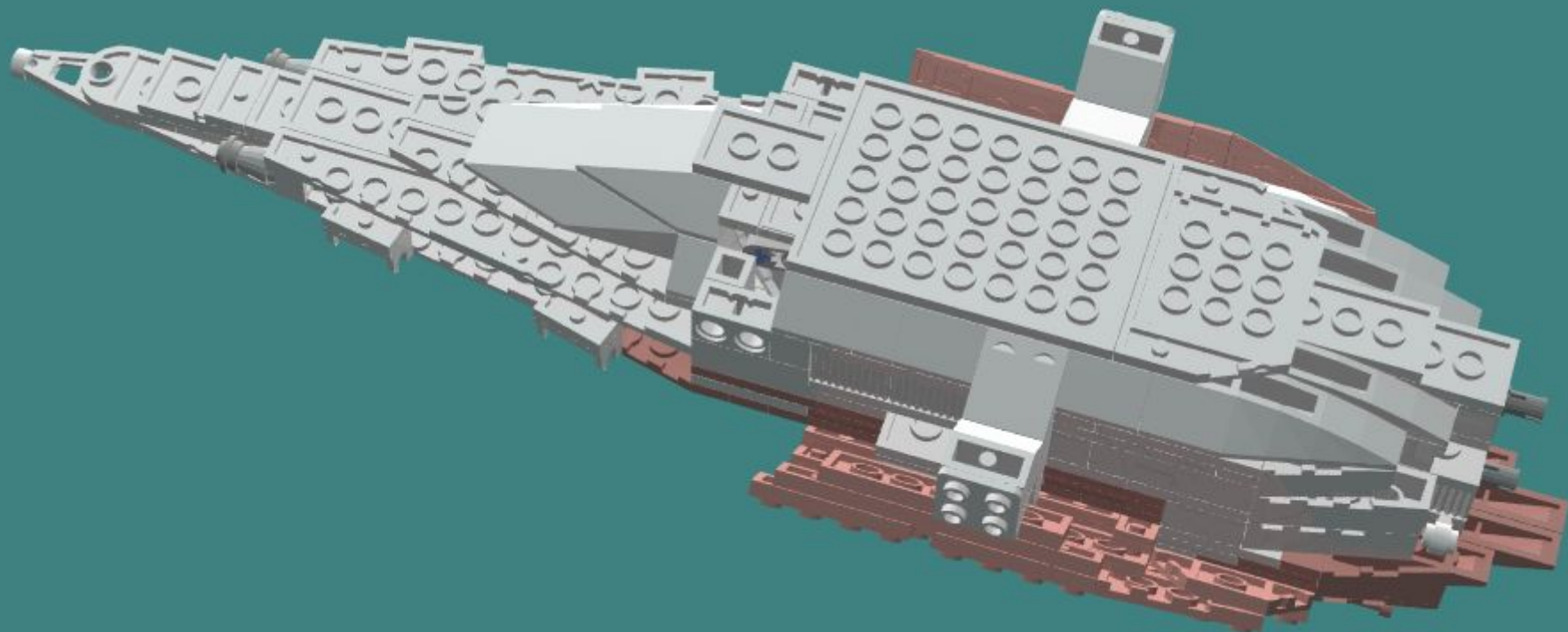

26

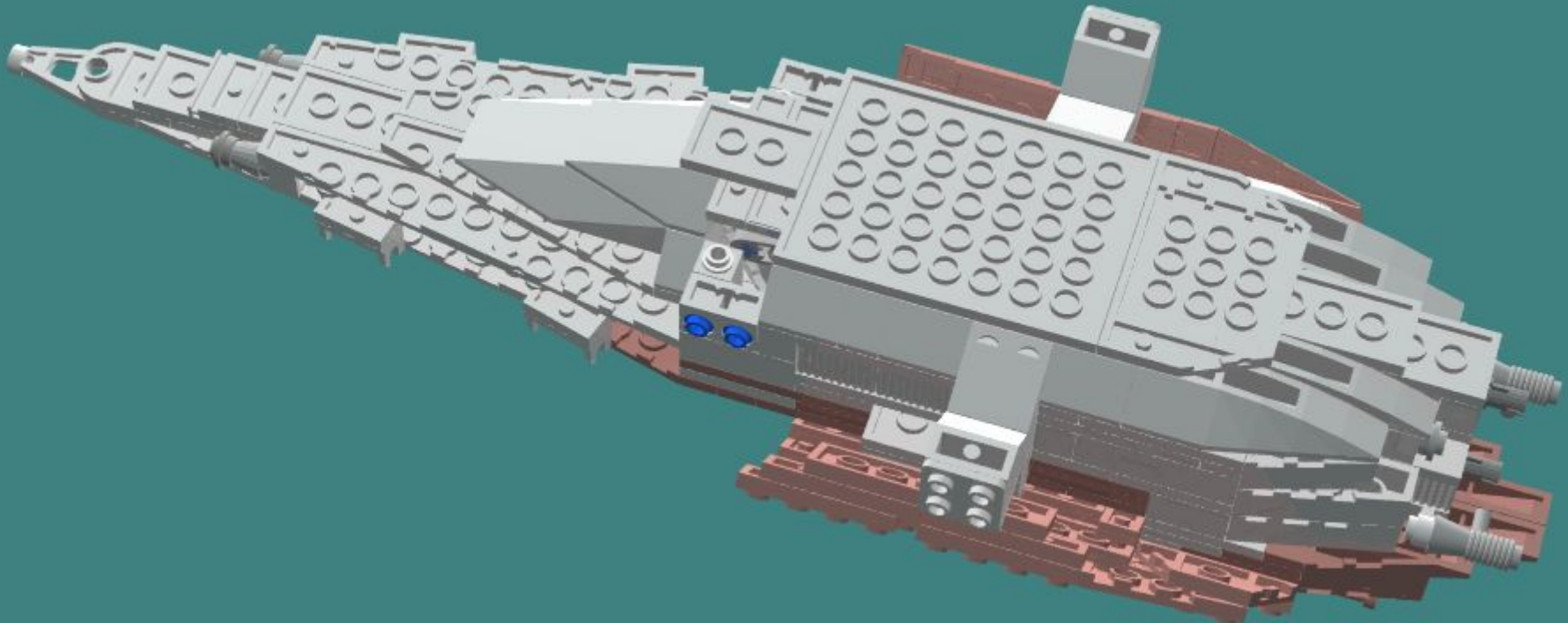

27

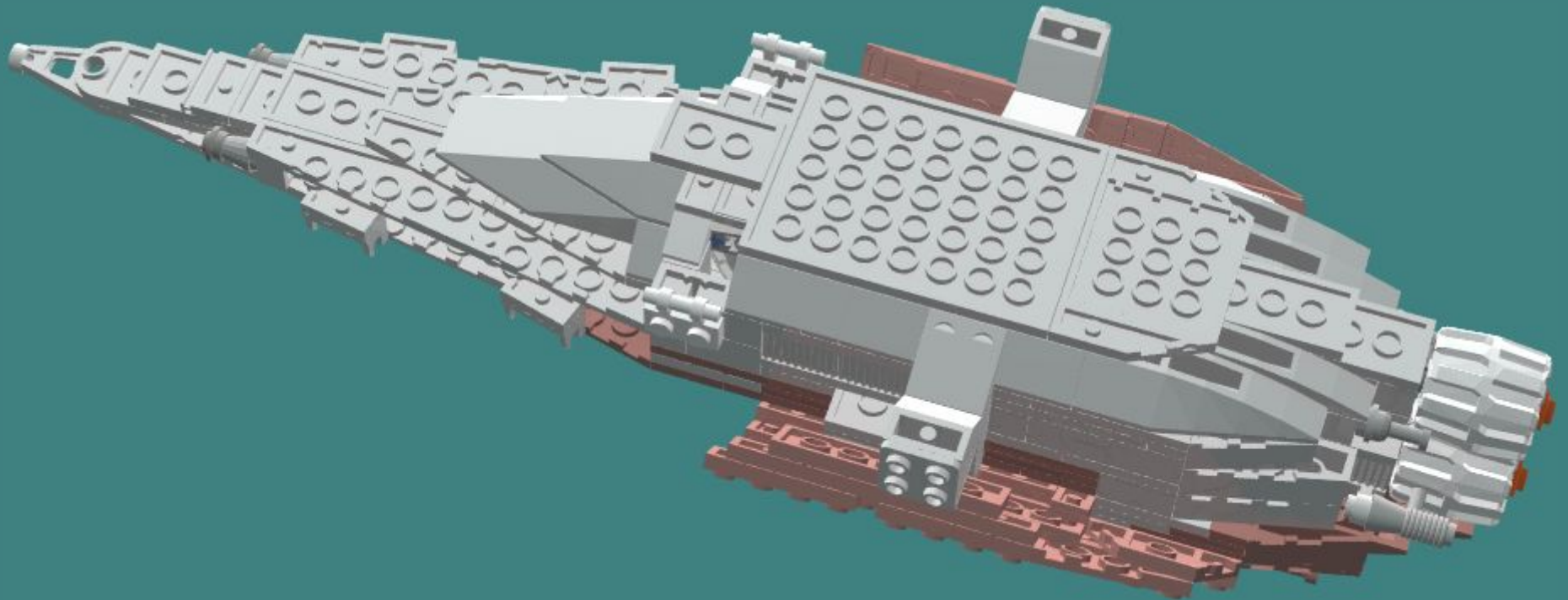

28



x2



x2

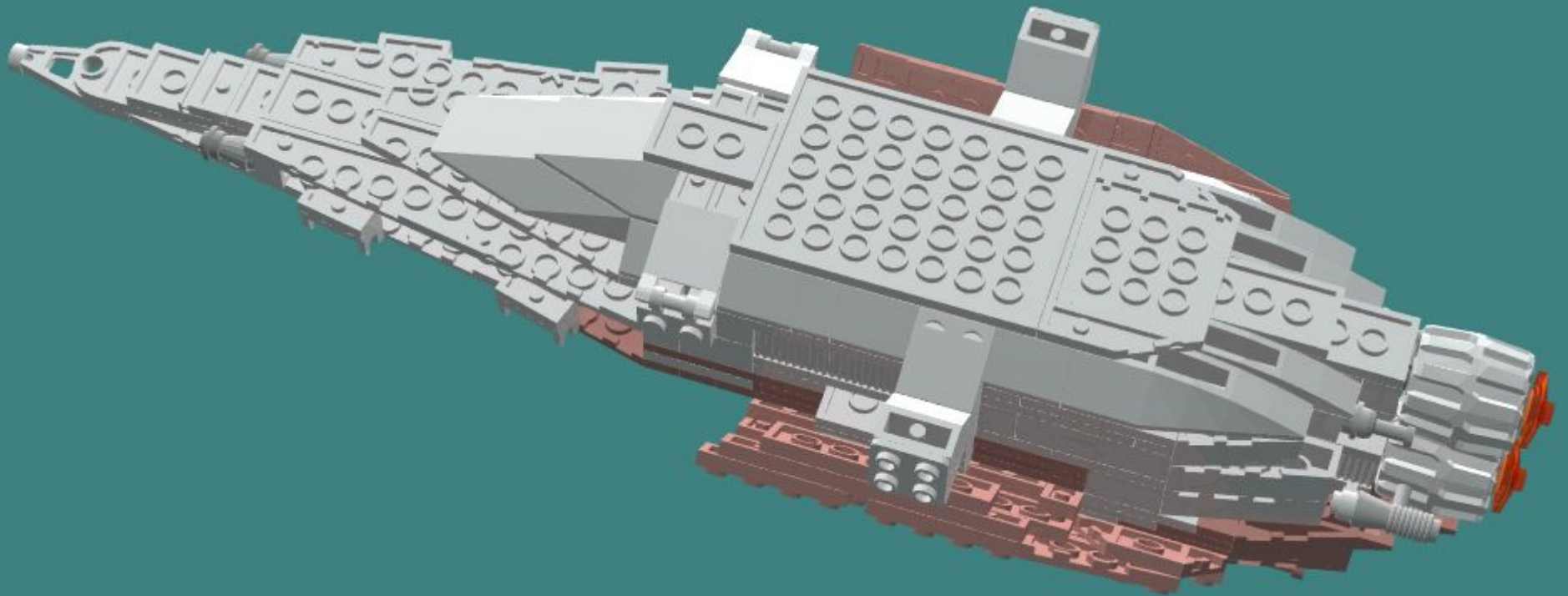

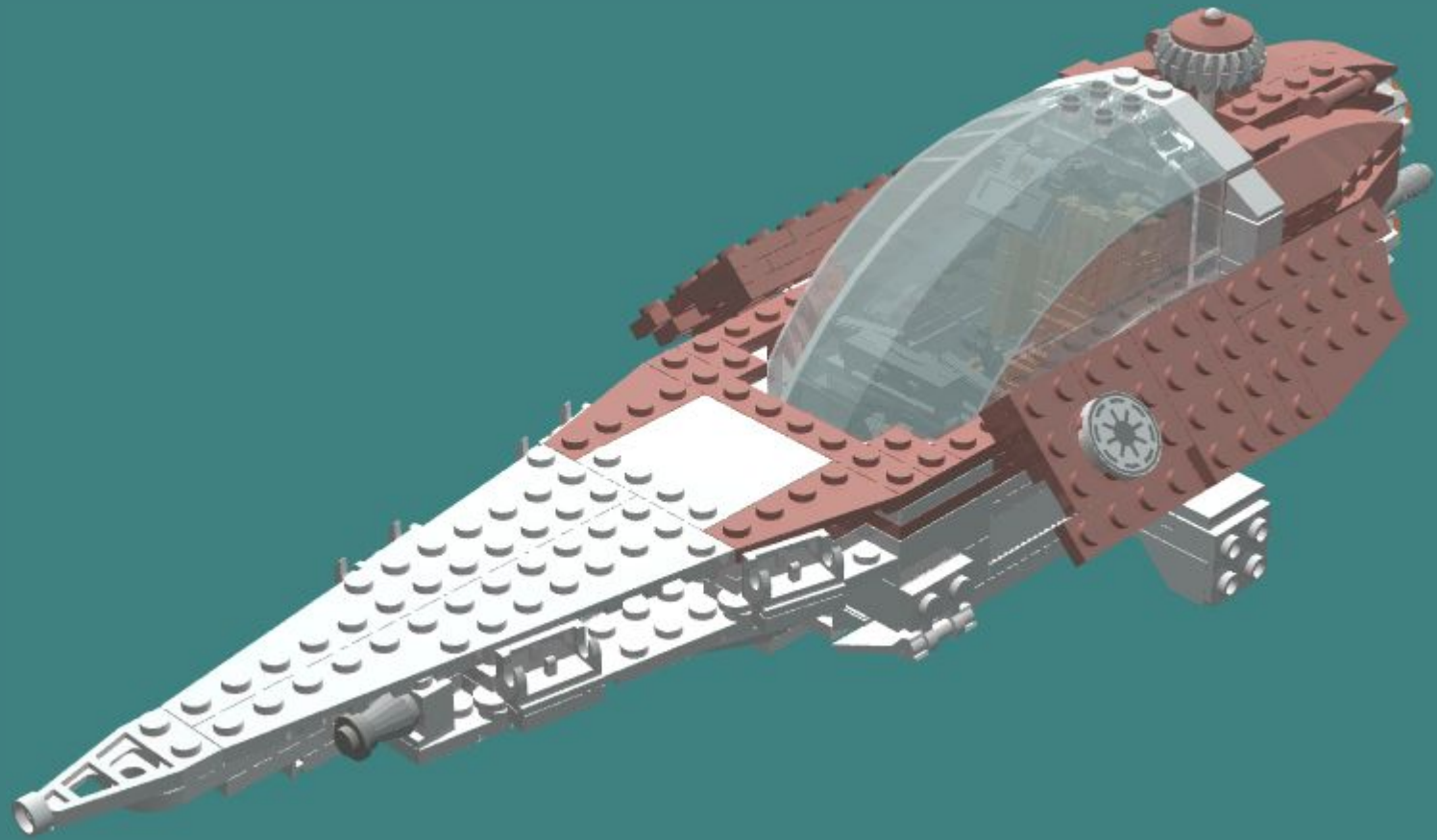

1

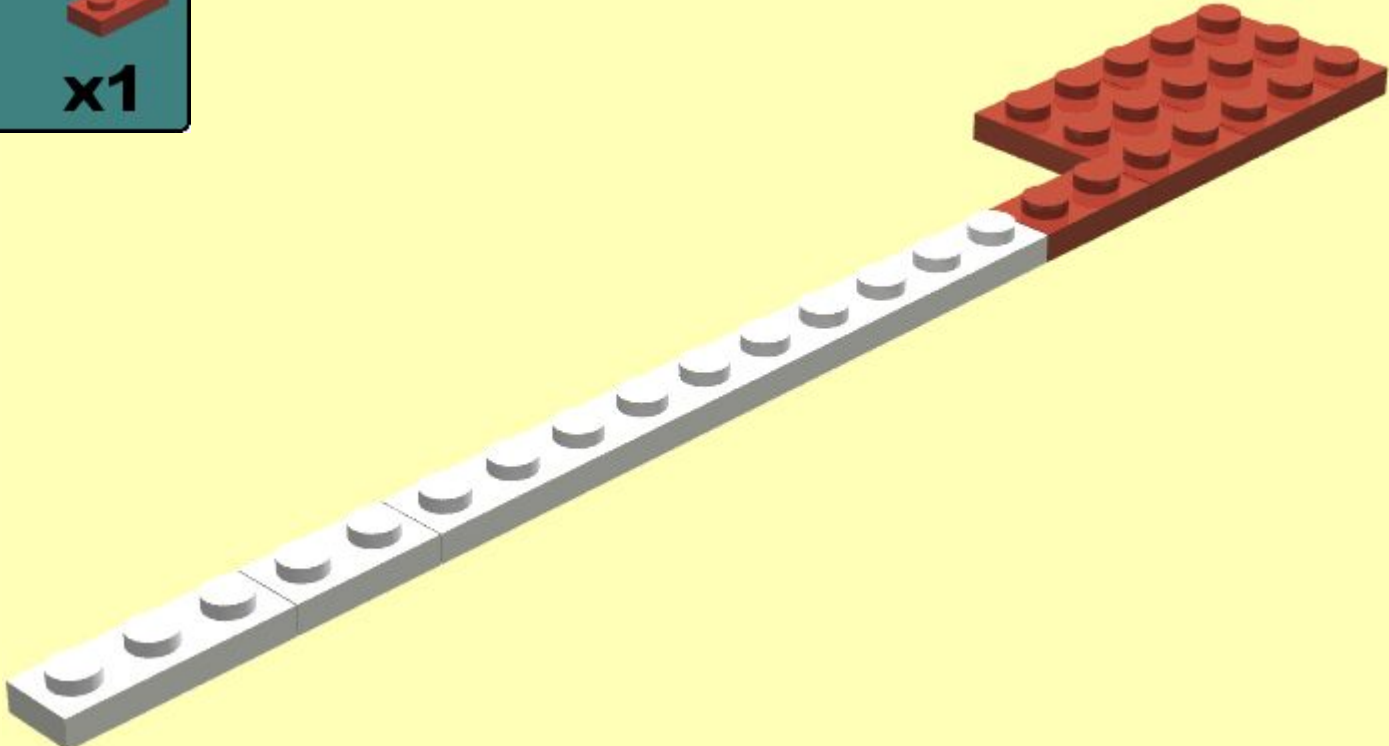
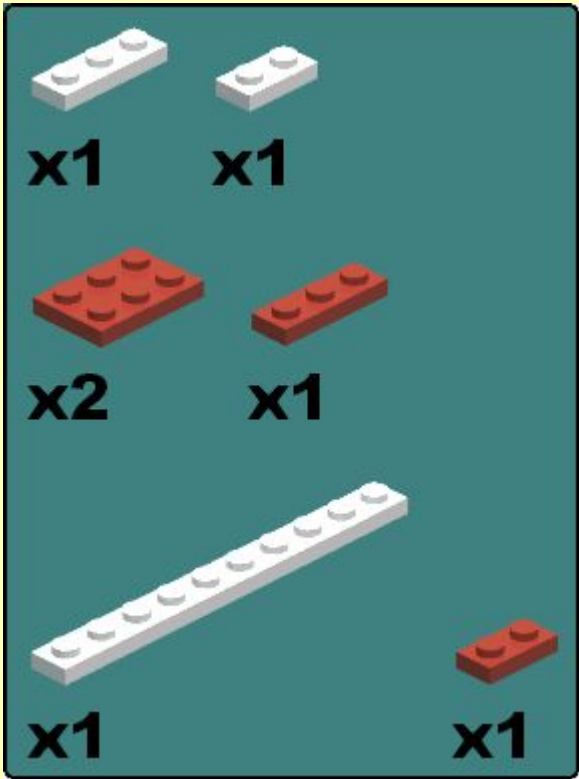

2

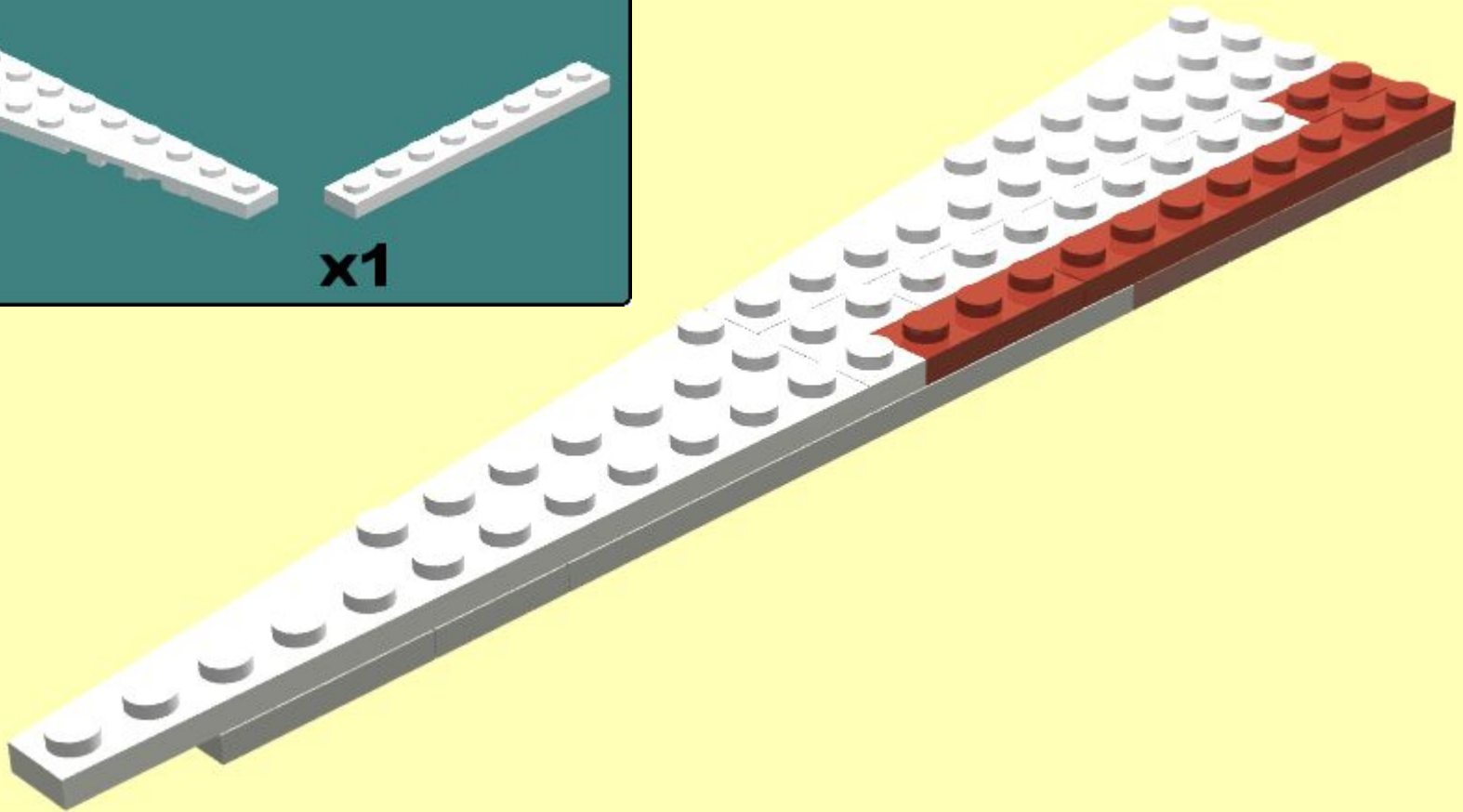
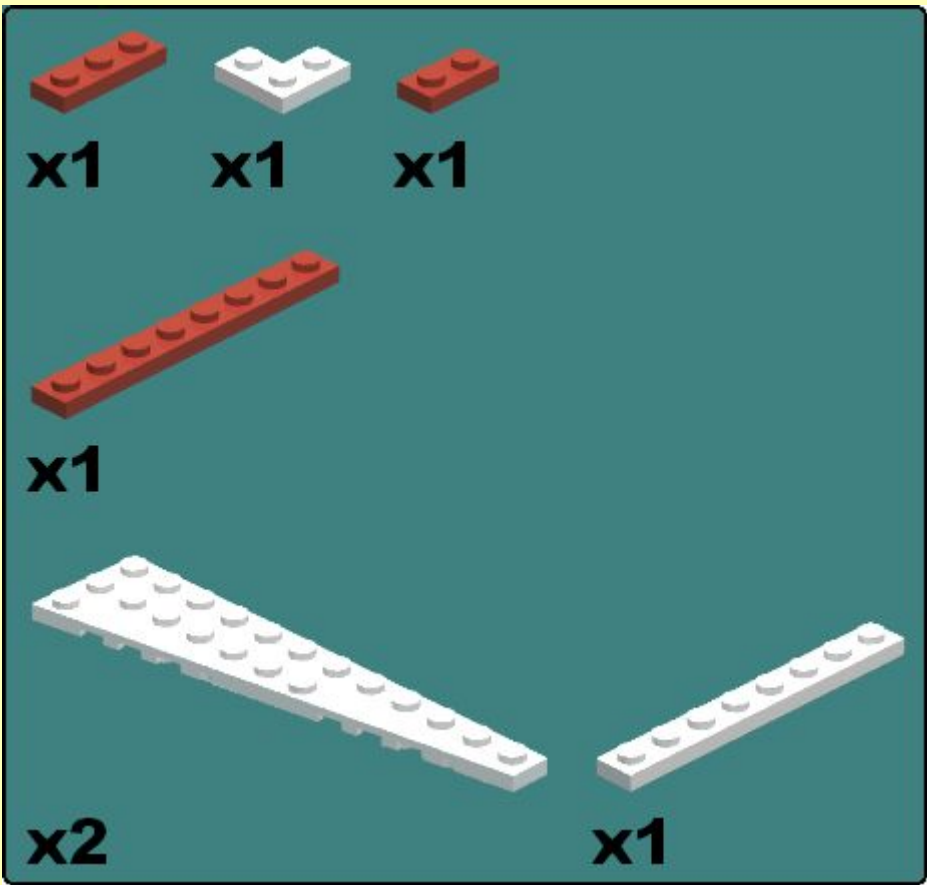

3

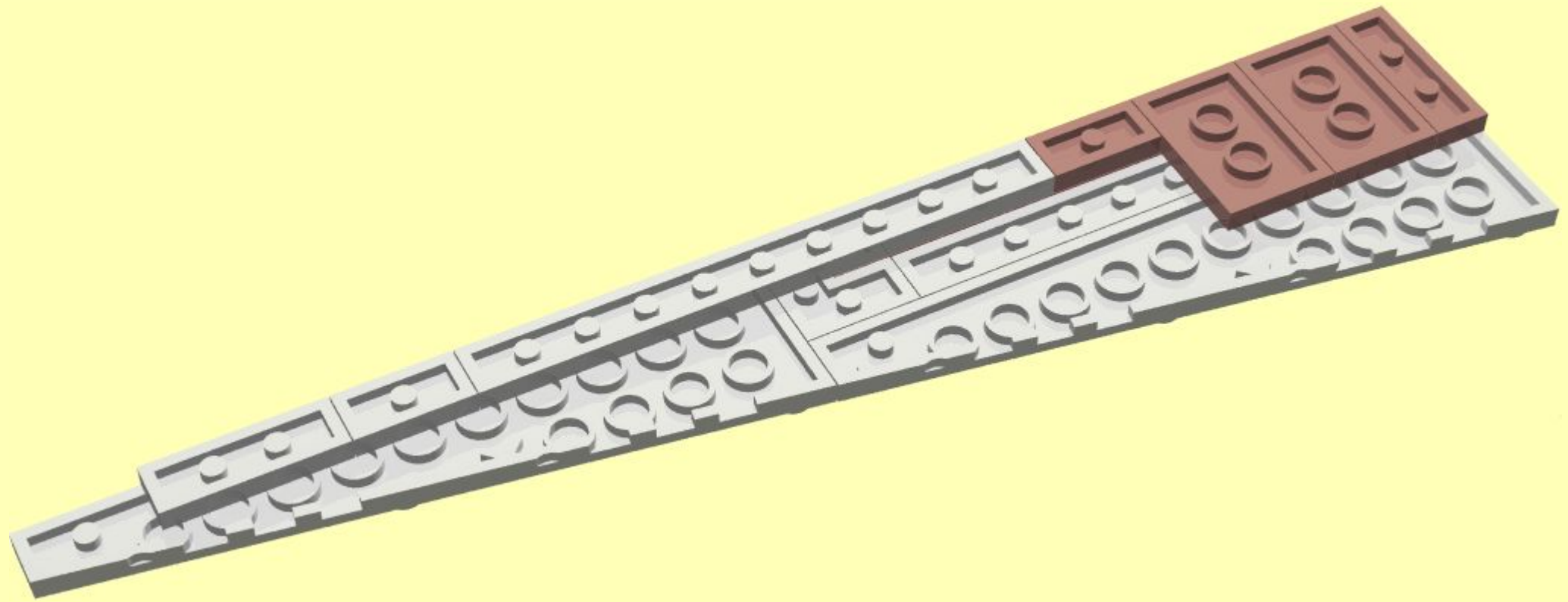

4

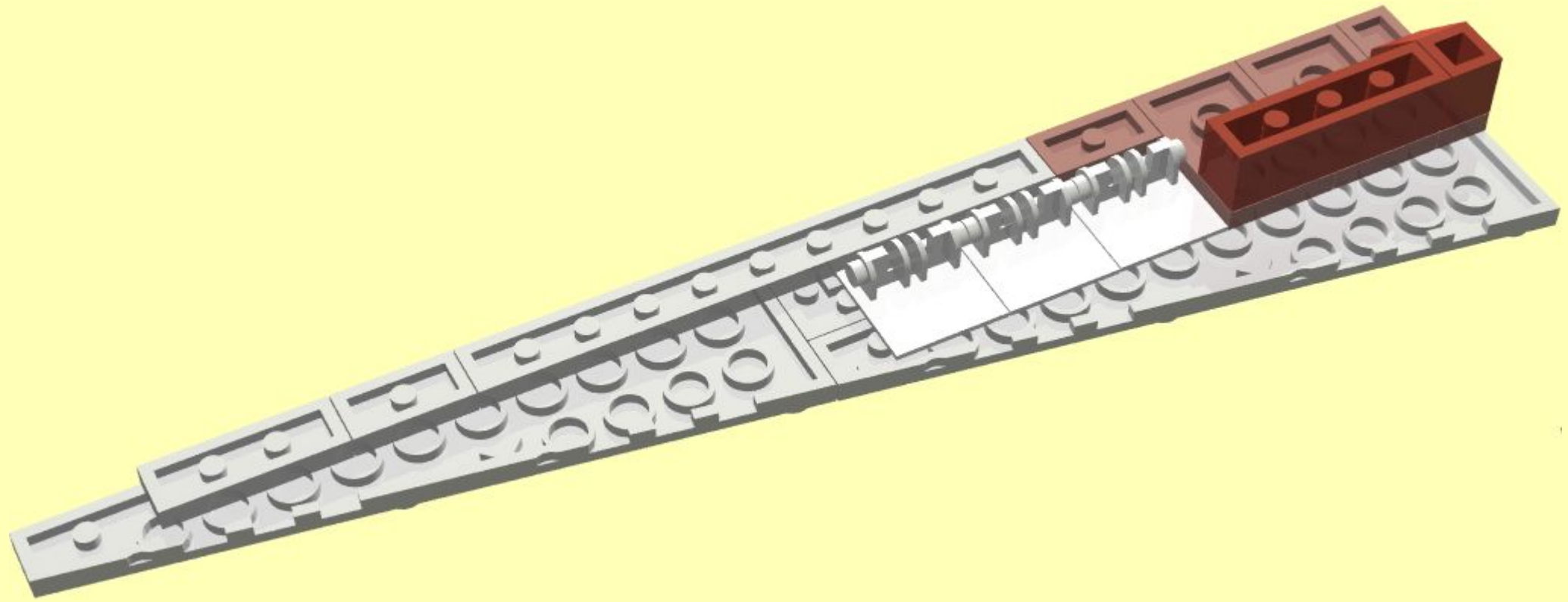
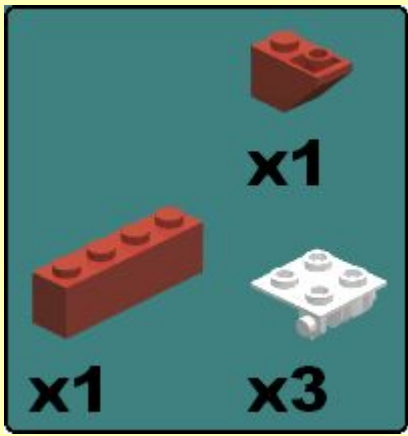

5

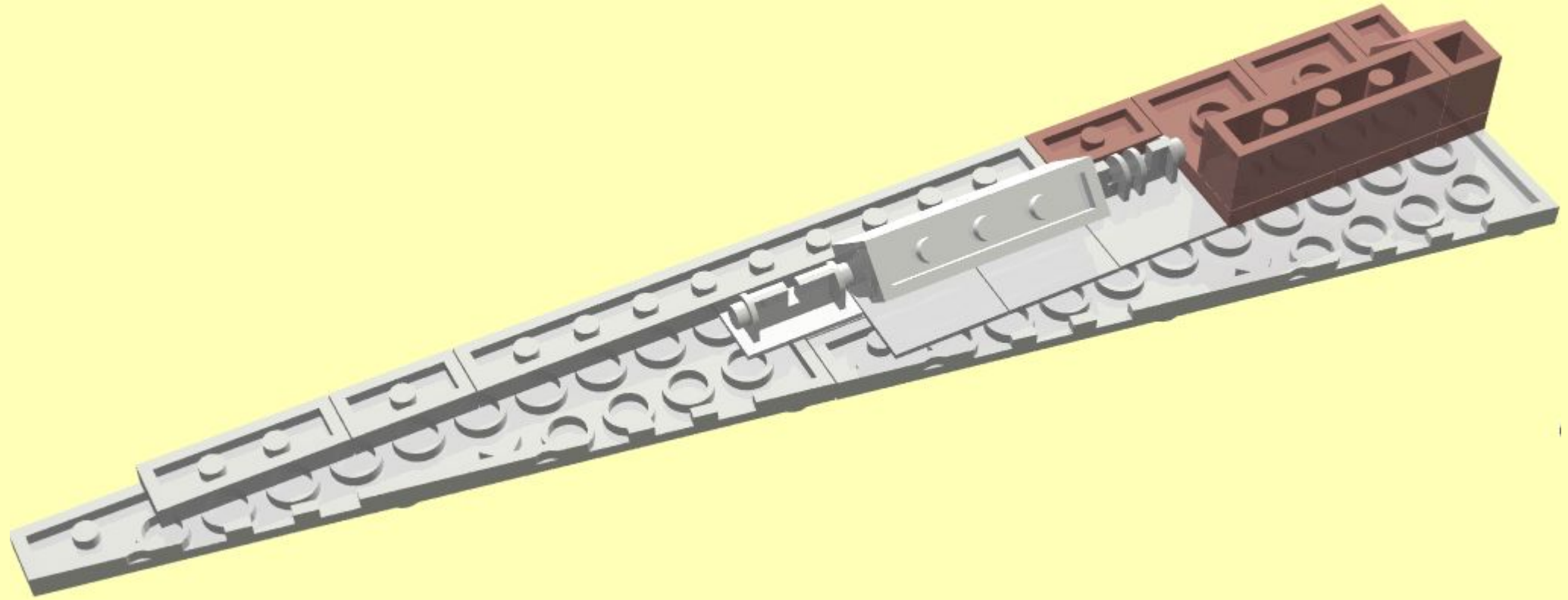
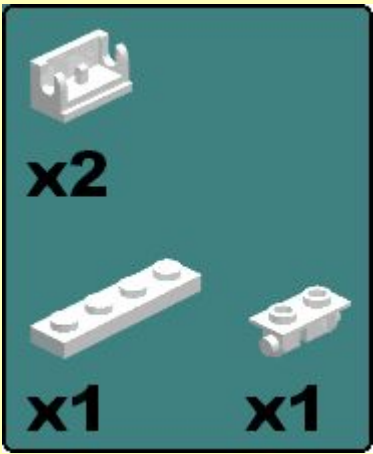

1

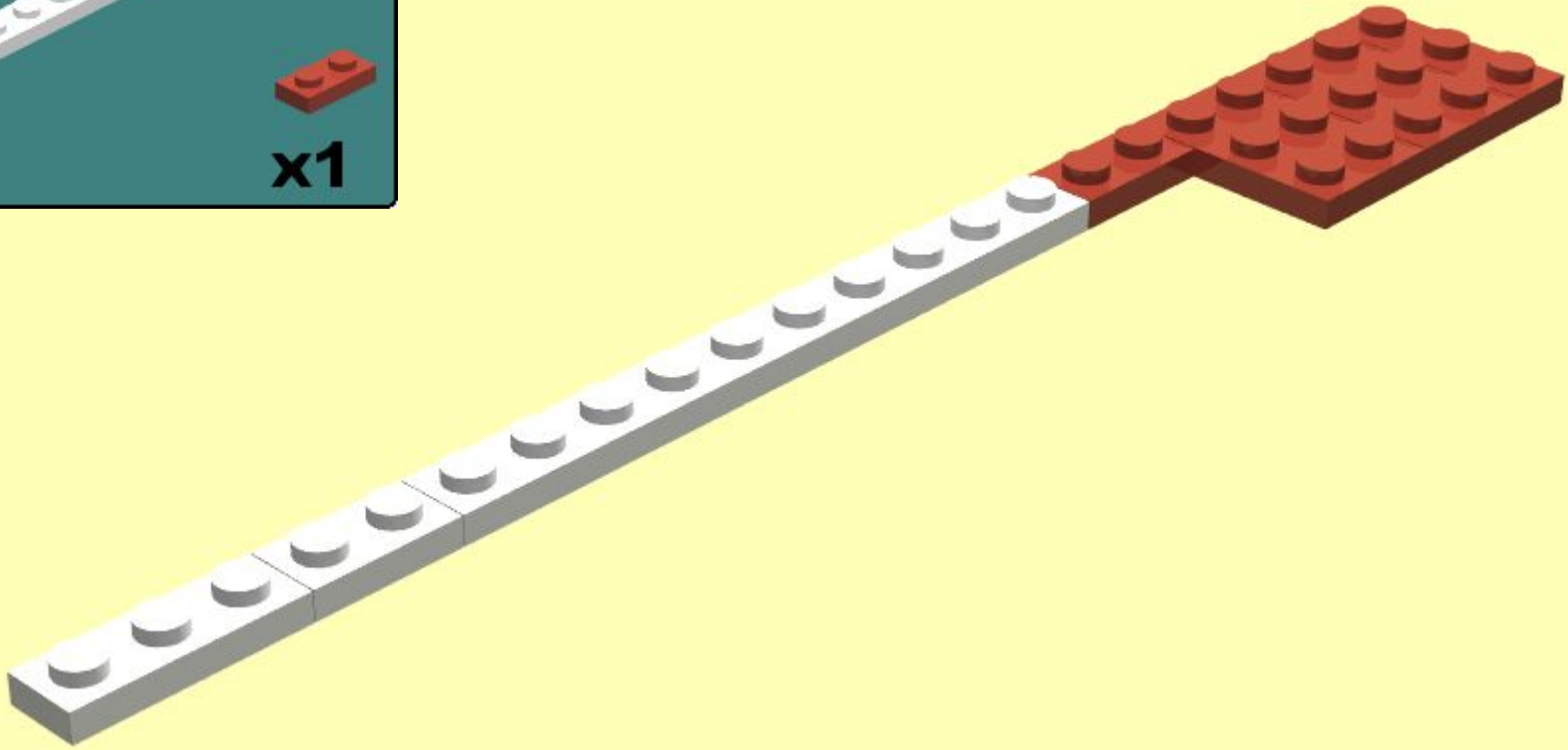
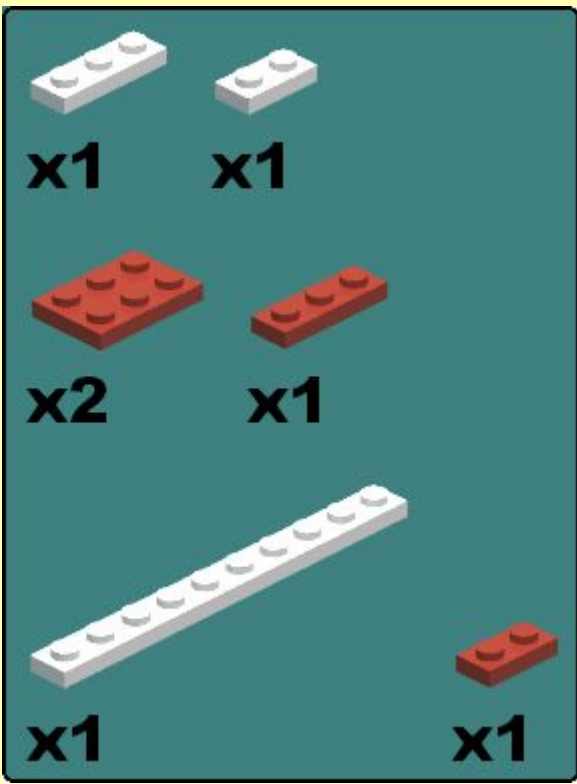

2

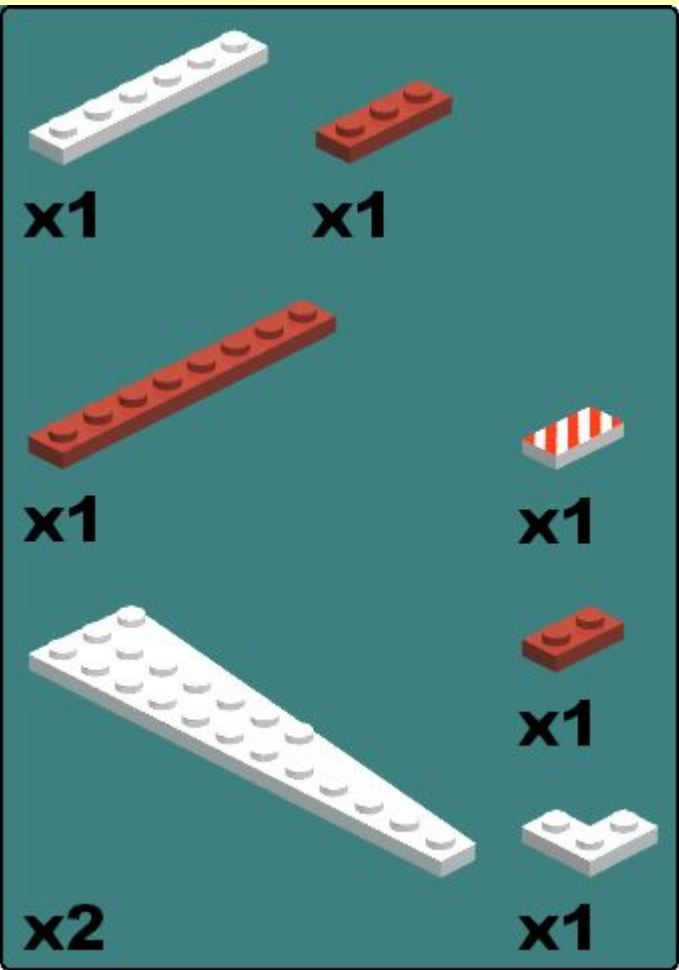

A parts list for step 2, displayed on a teal background. It includes the following items:

- White Technic beam 1x10, labeled **x1**
- Red Technic beam 1x3, labeled **x1**
- Red Technic beam 1x7, labeled **x1**
- Red and white striped Technic beam 1x2, labeled **x1**
- White Technic beam 1x15, labeled **x2**
- Red Technic beam 1x2, labeled **x1**
- White Technic L-shaped Technic connector 1x2, labeled **x1**

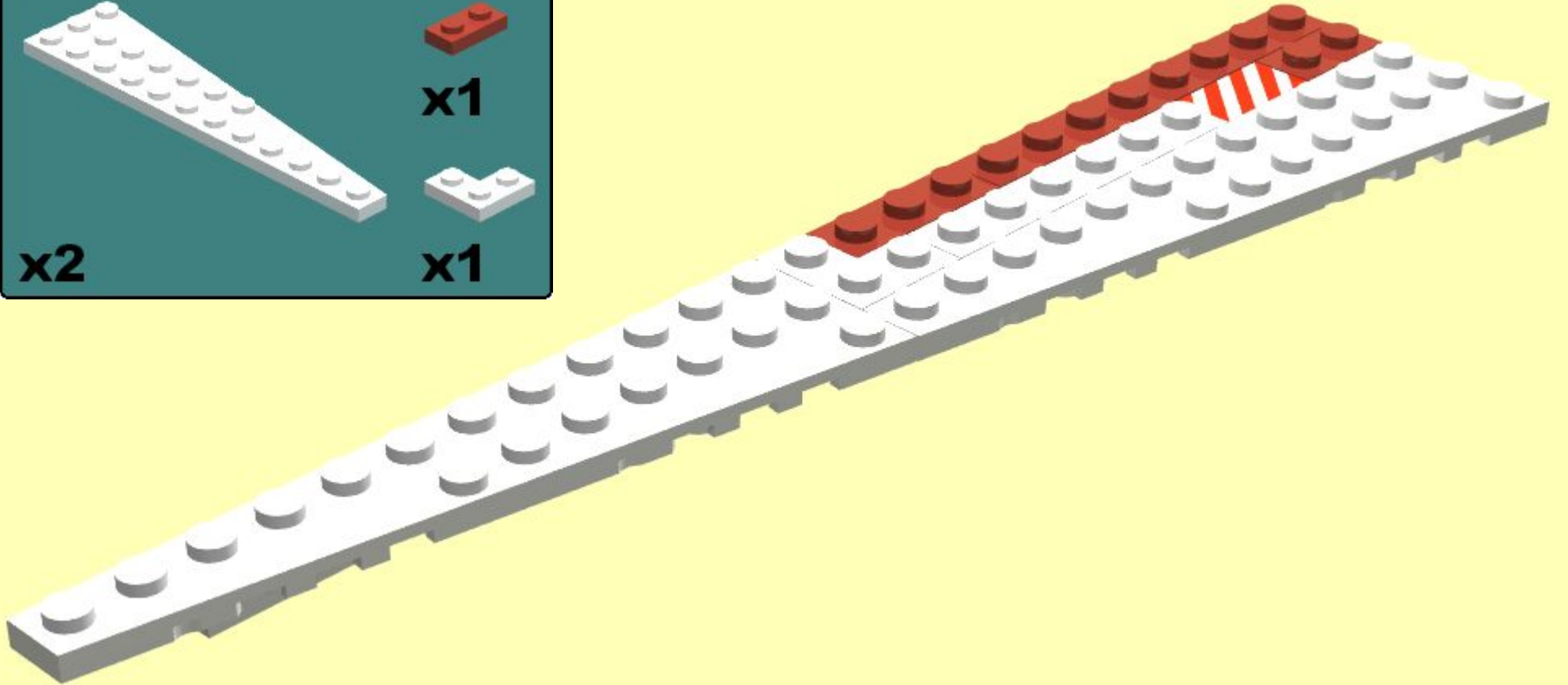

3

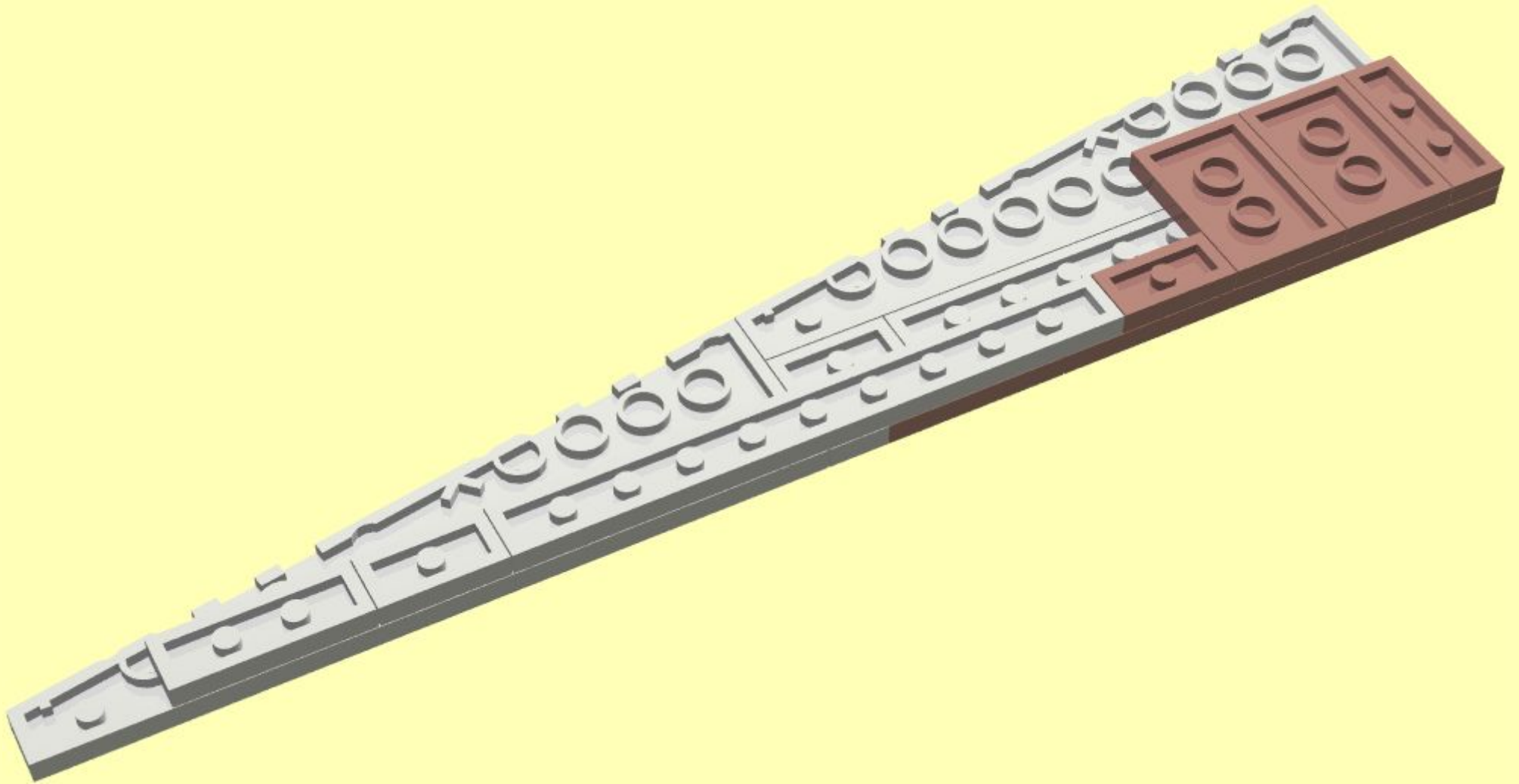

4

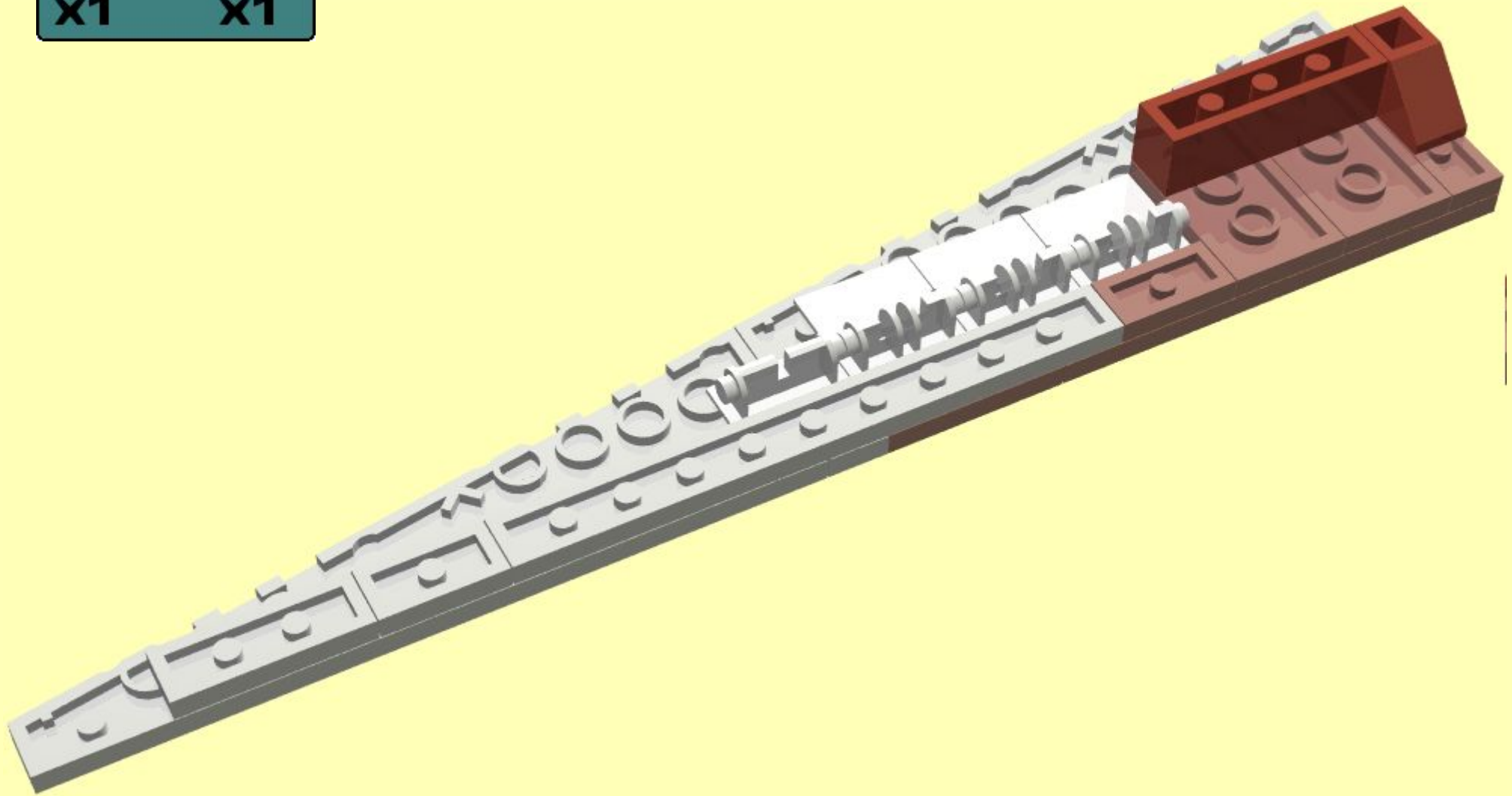
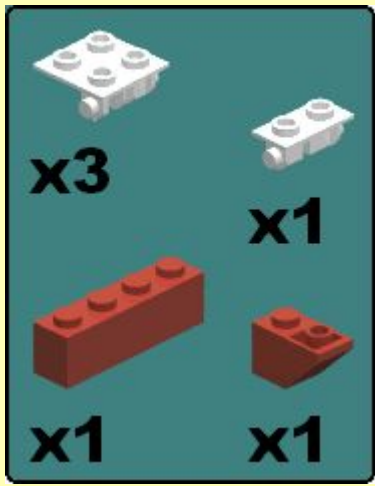

5



x2



x1

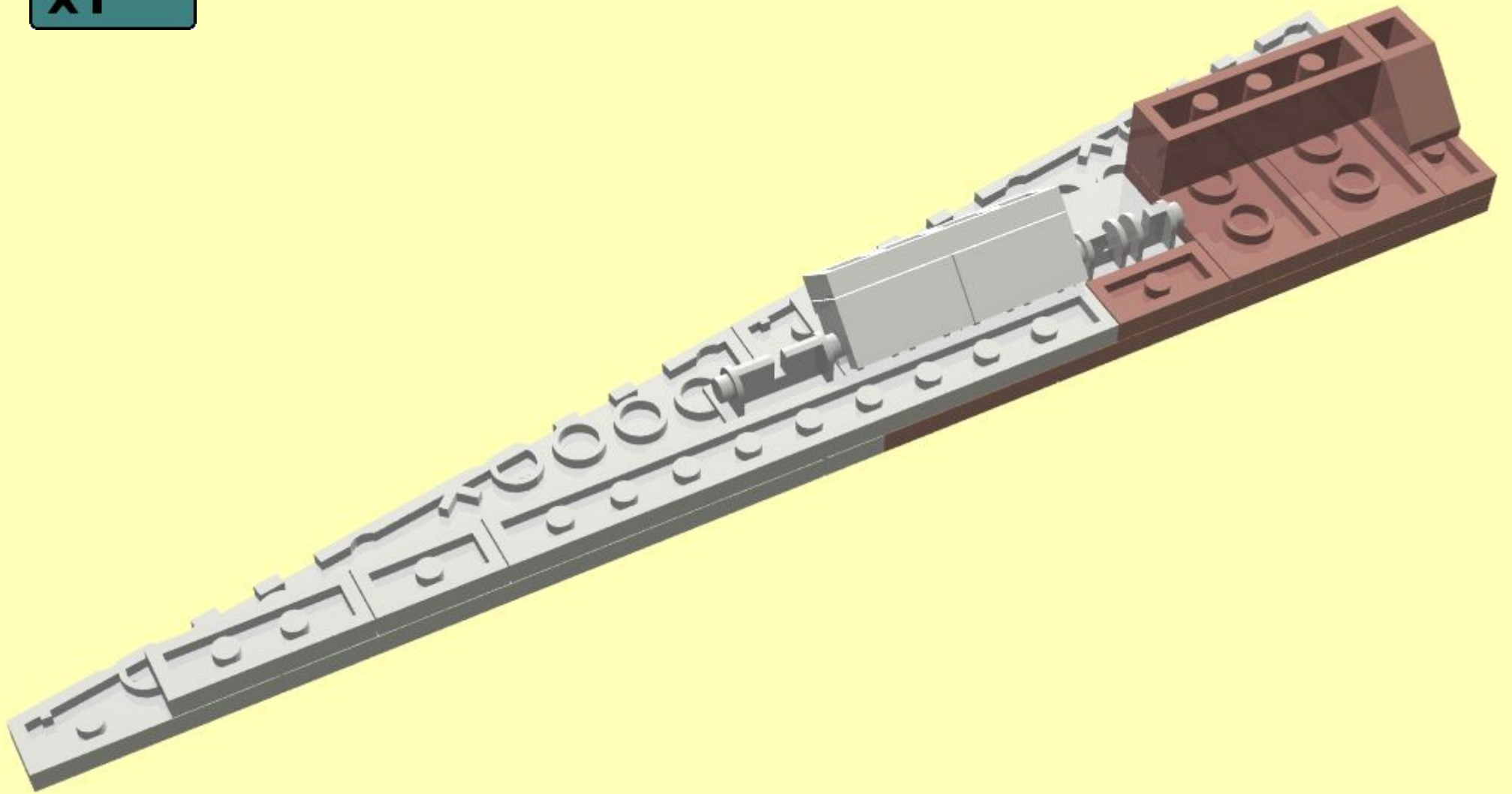

30

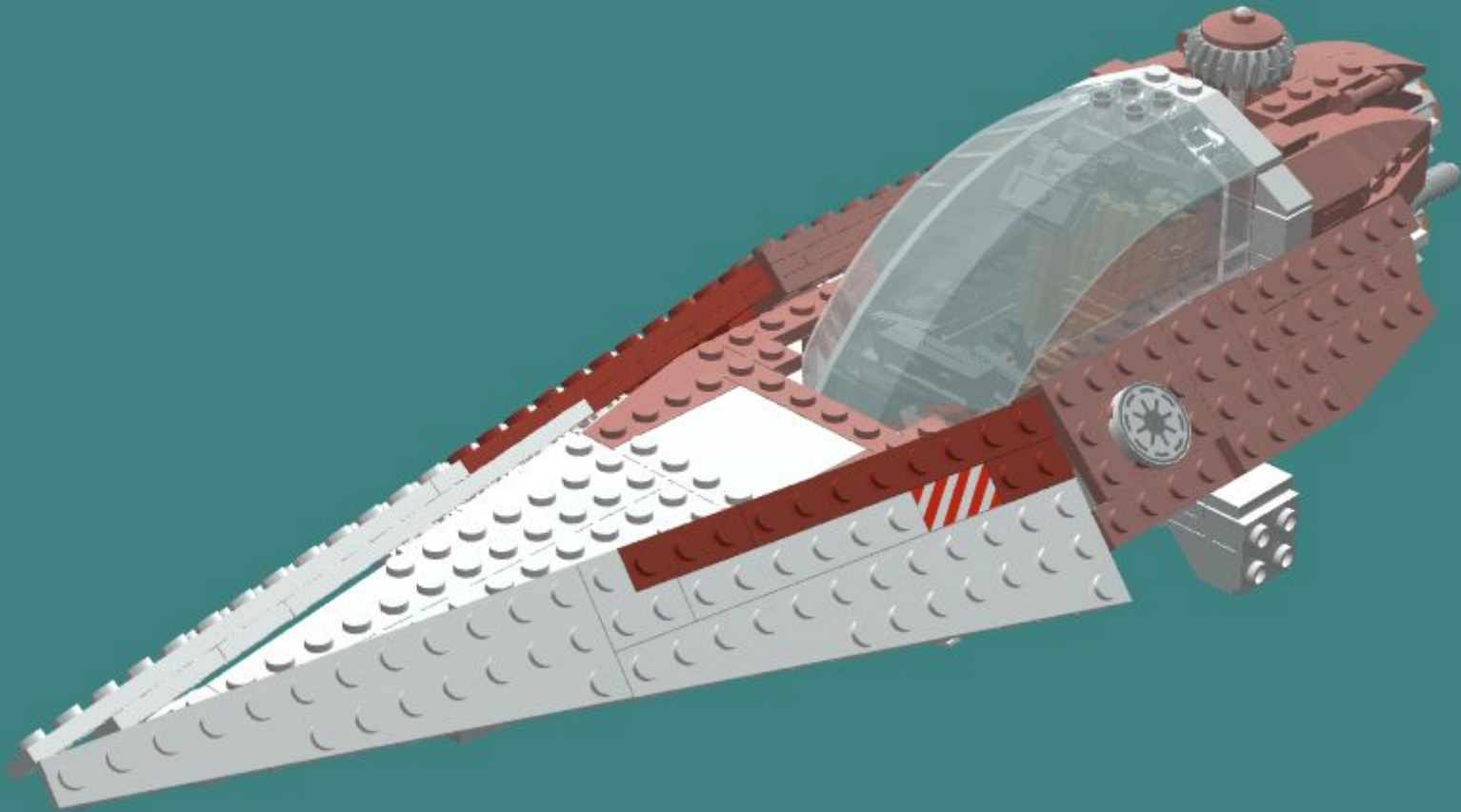

1

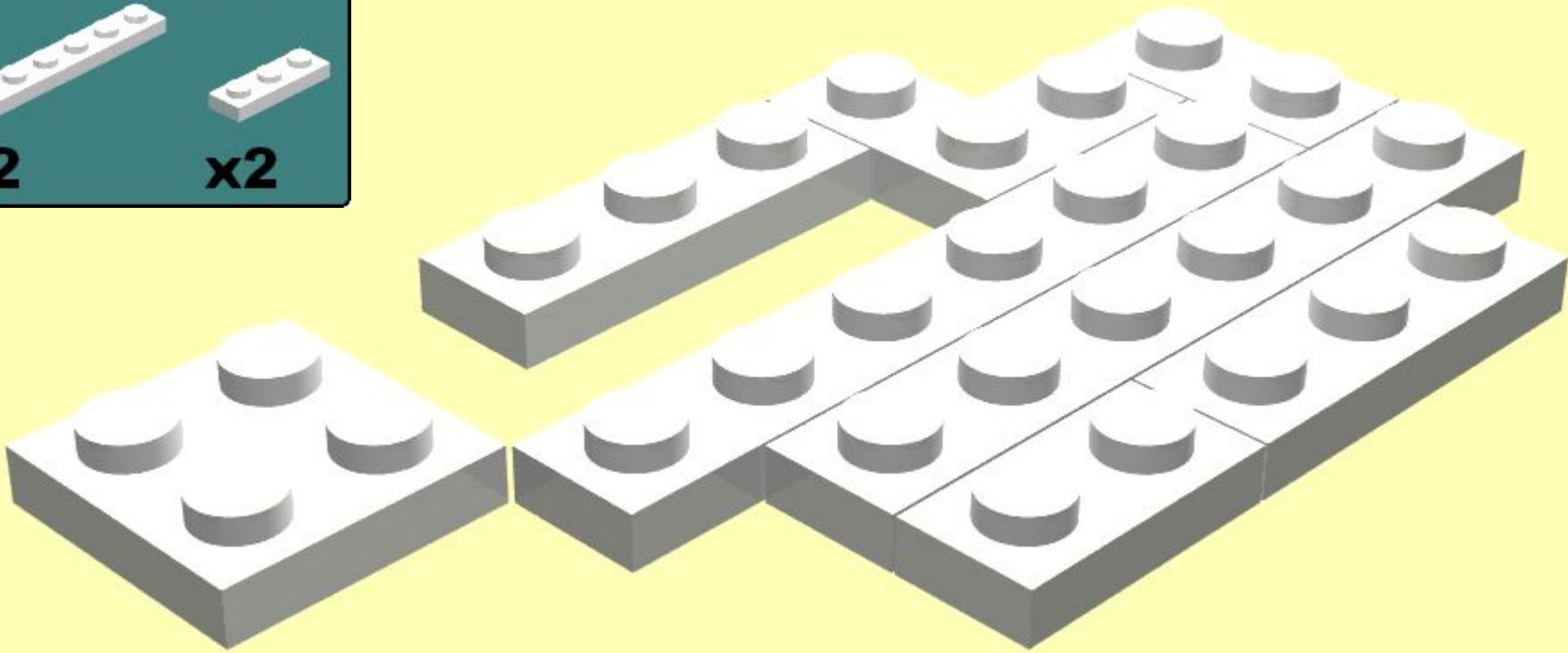
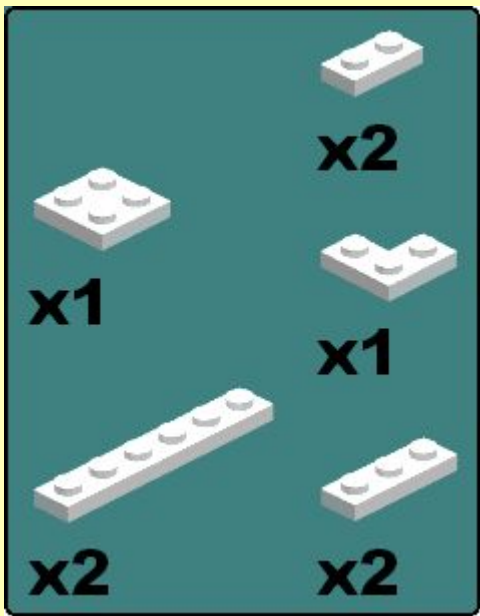

2

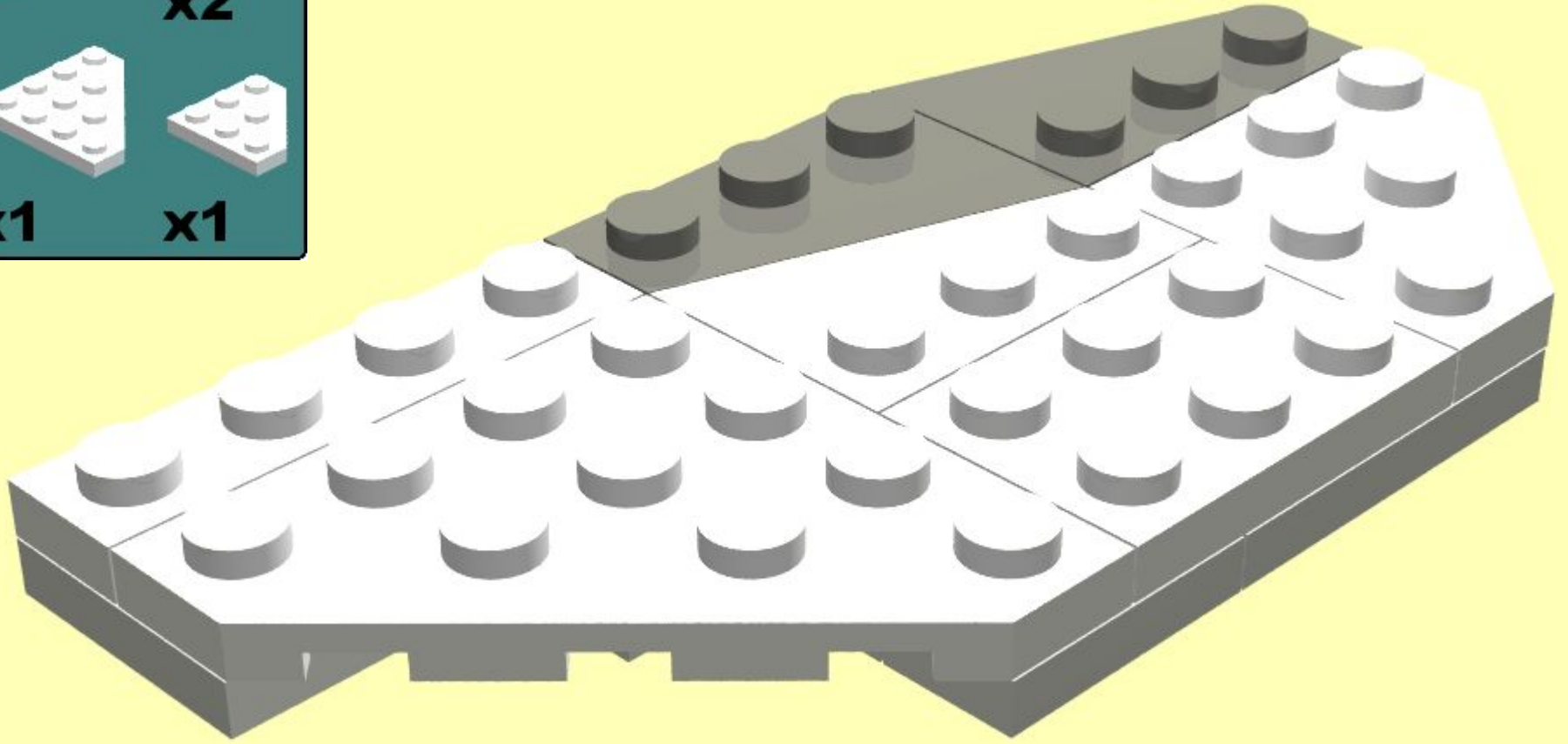
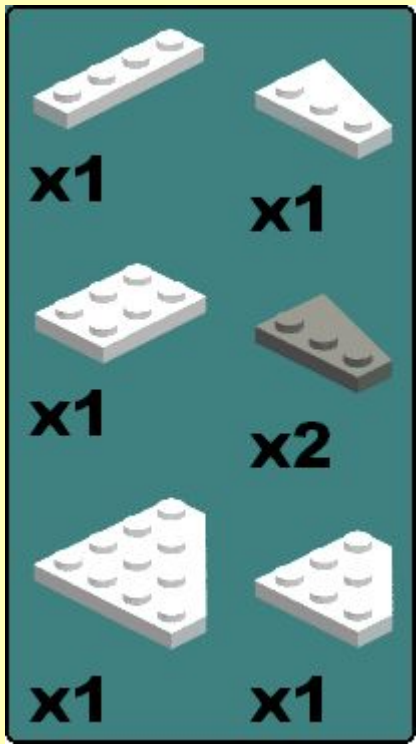

3

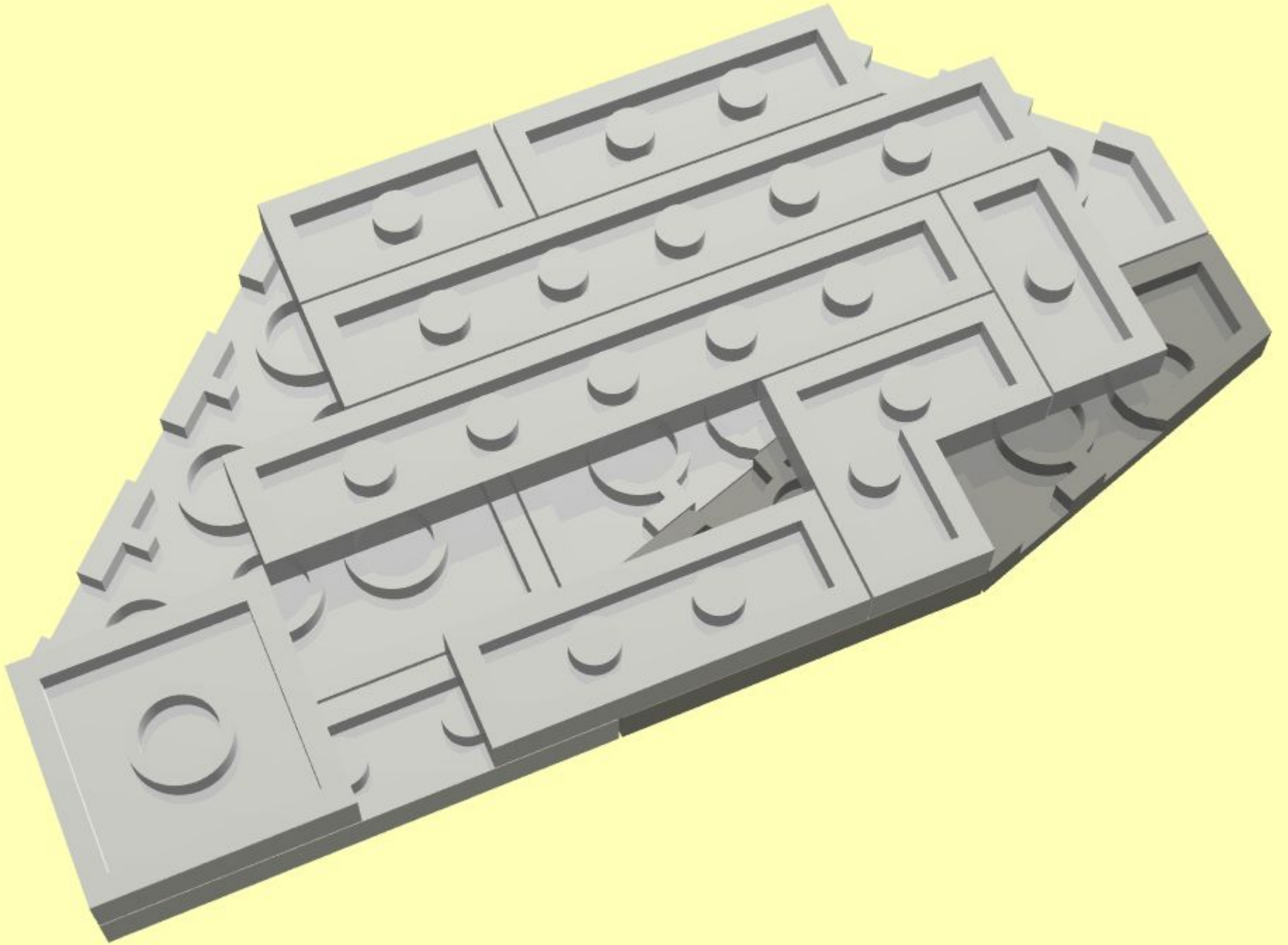

4



x3



x1

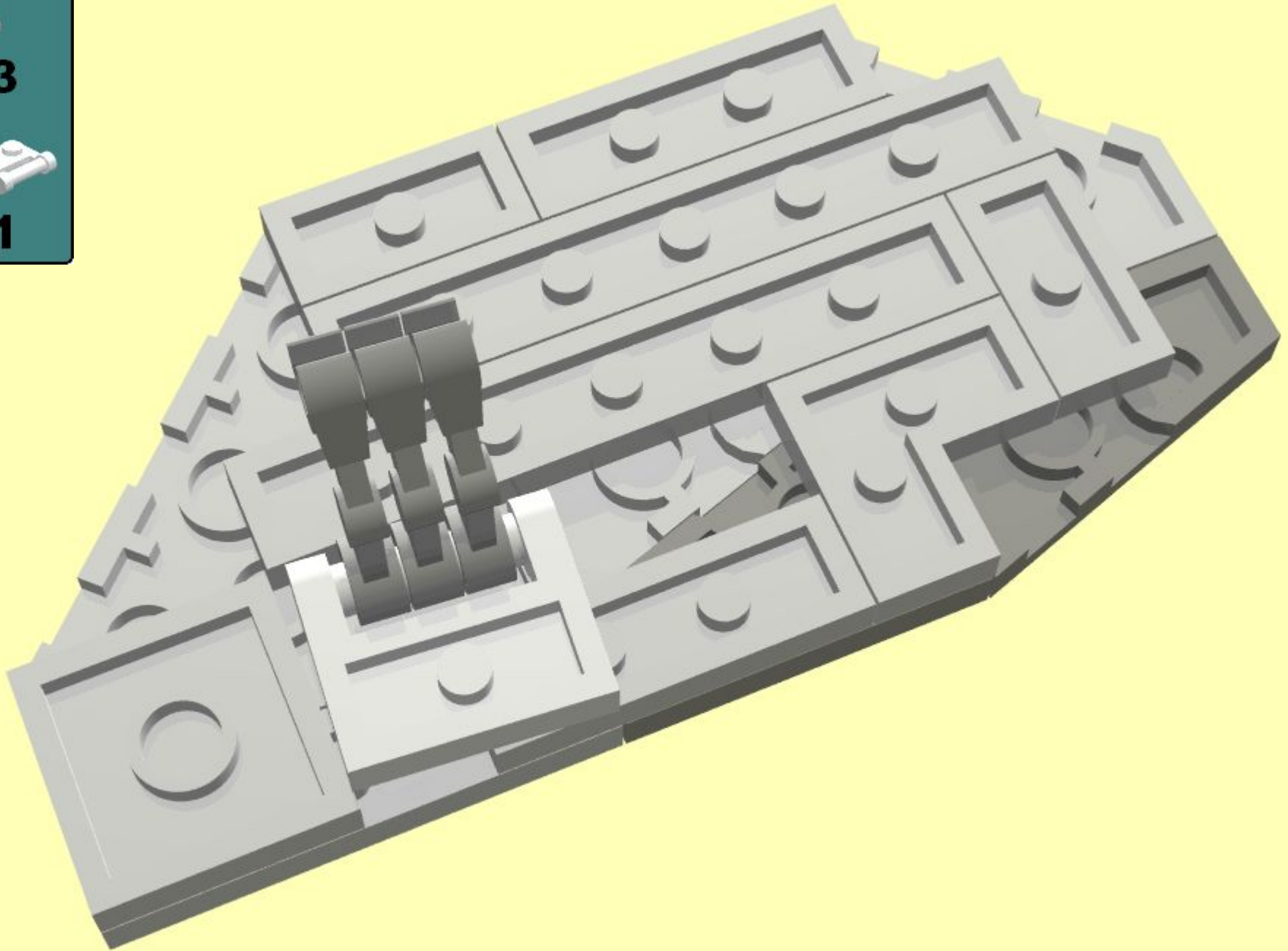

1

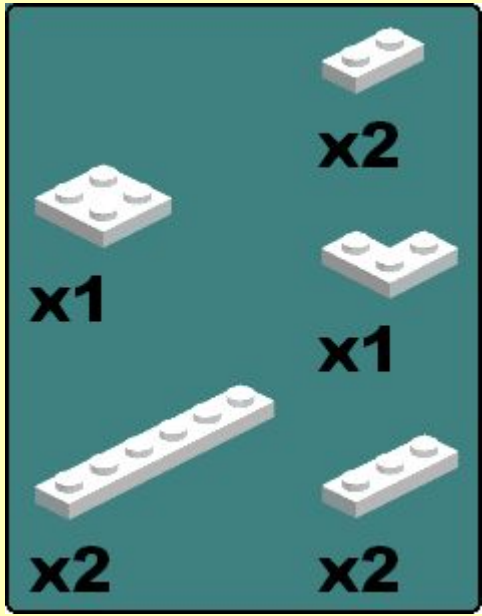

A parts list for step 1, displayed on a dark teal background. It includes five items with their respective quantities:

- 1 x 2-hole white Technic brick (top right)
- 2 x 2-hole white Technic brick (middle right)
- 1 x 2-hole white Technic L-shaped Technic brick (middle right)
- 1 x 5-hole white Technic Technic brick (middle left)
- 2 x 5-hole white Technic Technic brick (bottom left)
- 2 x 2-hole white Technic Technic brick (bottom right)

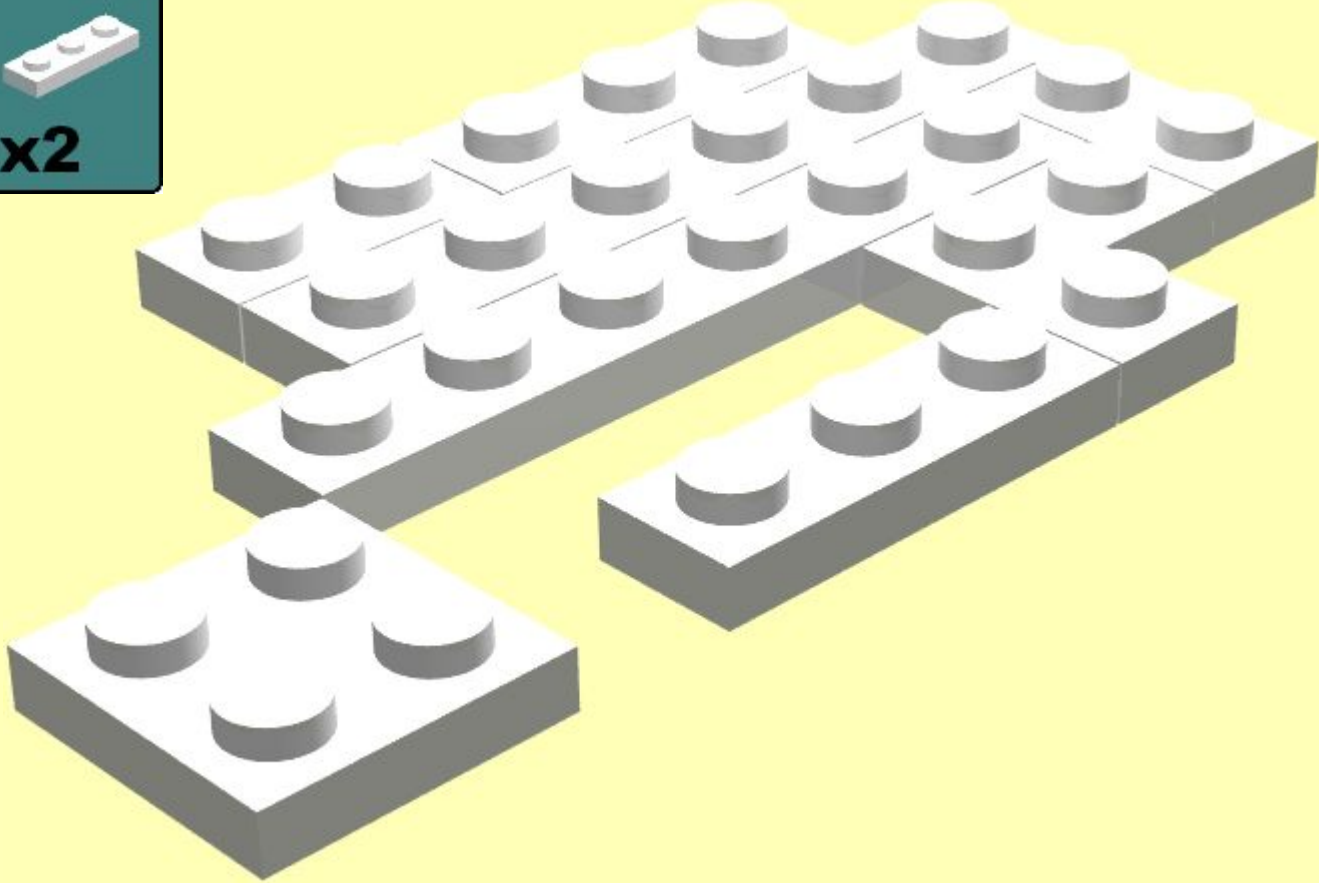

2

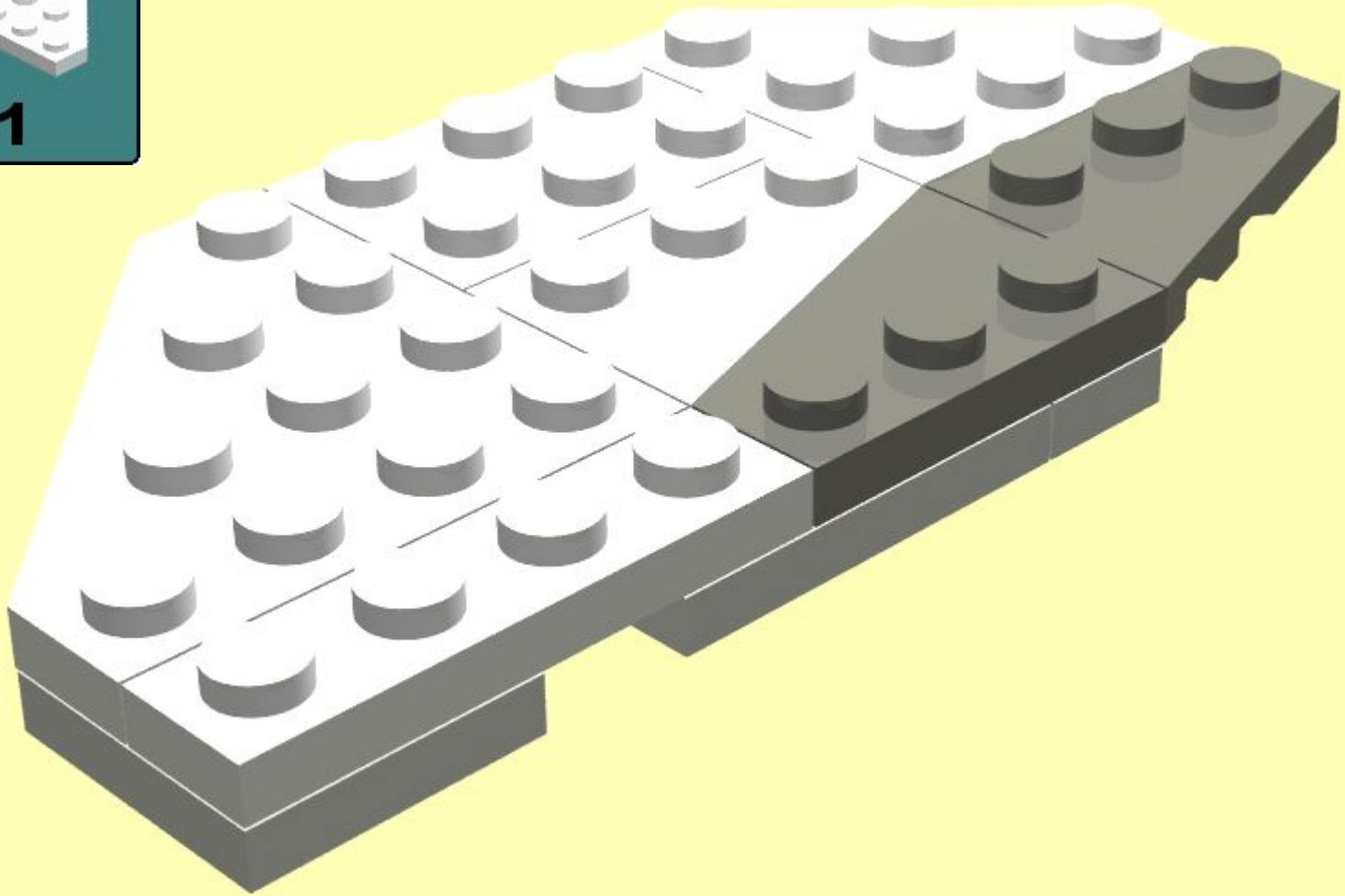
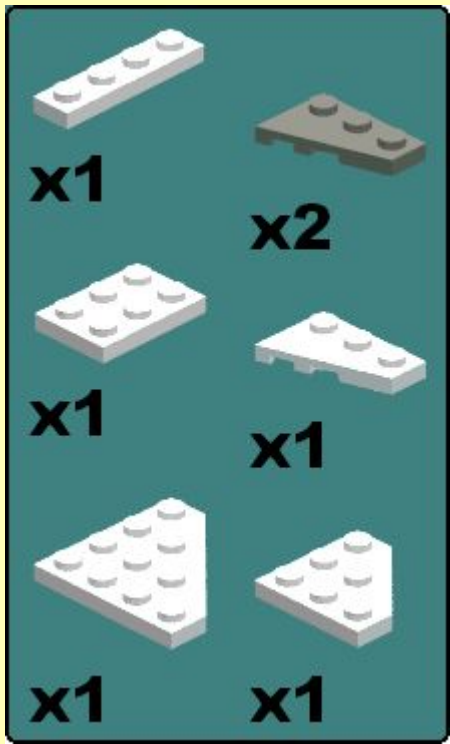

3

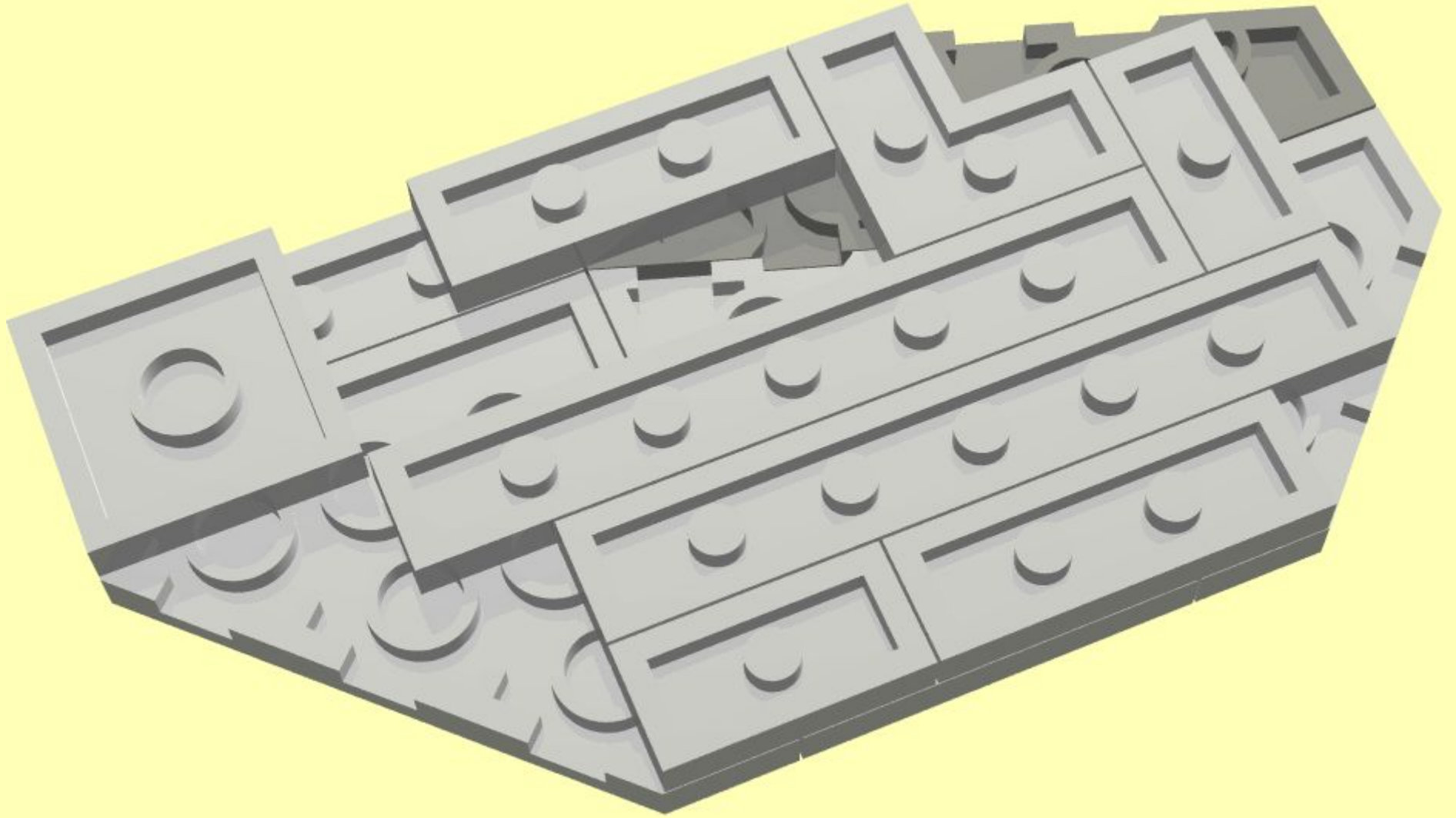

4



x3





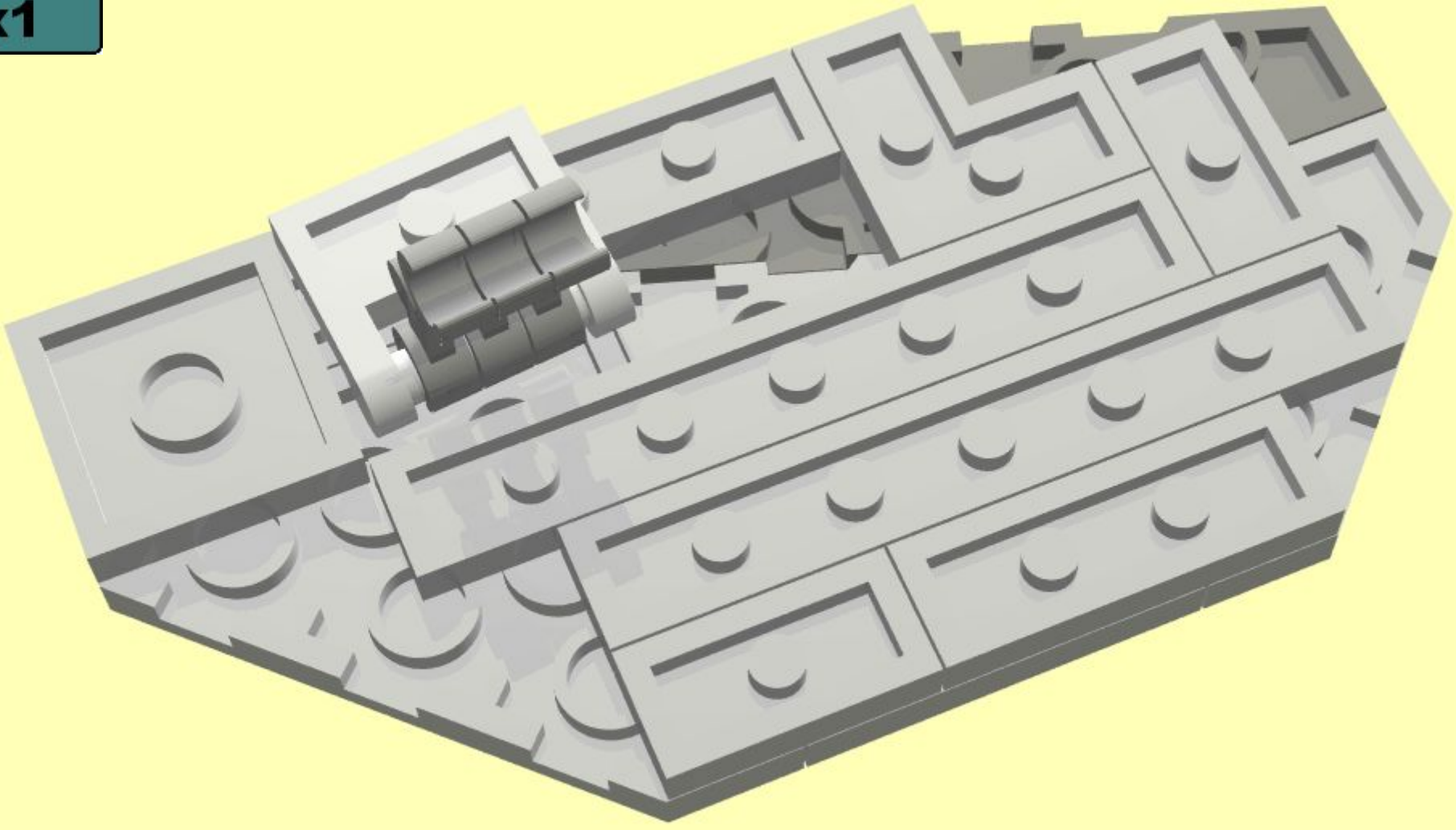

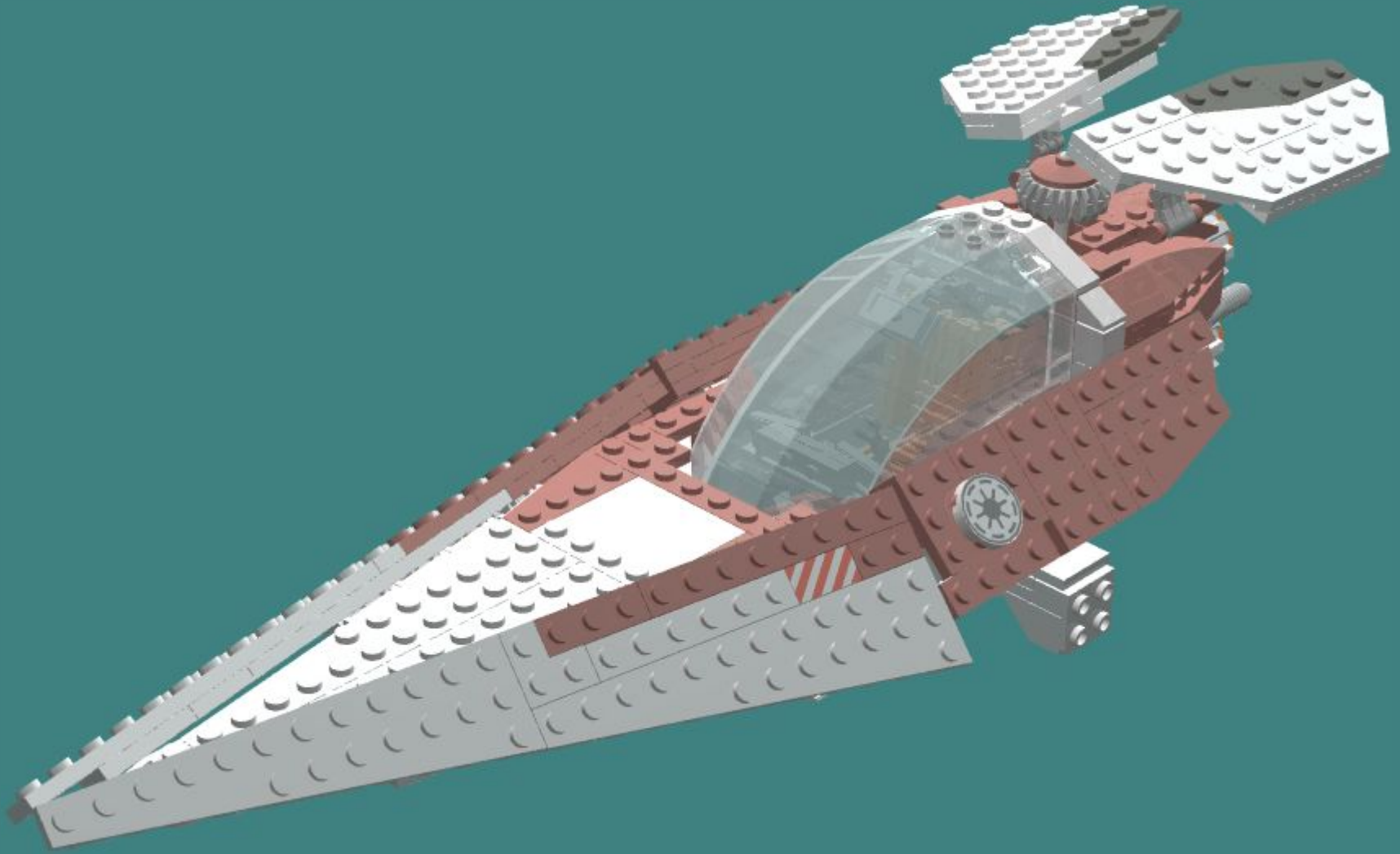

x1

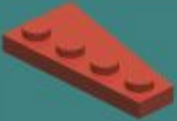

31







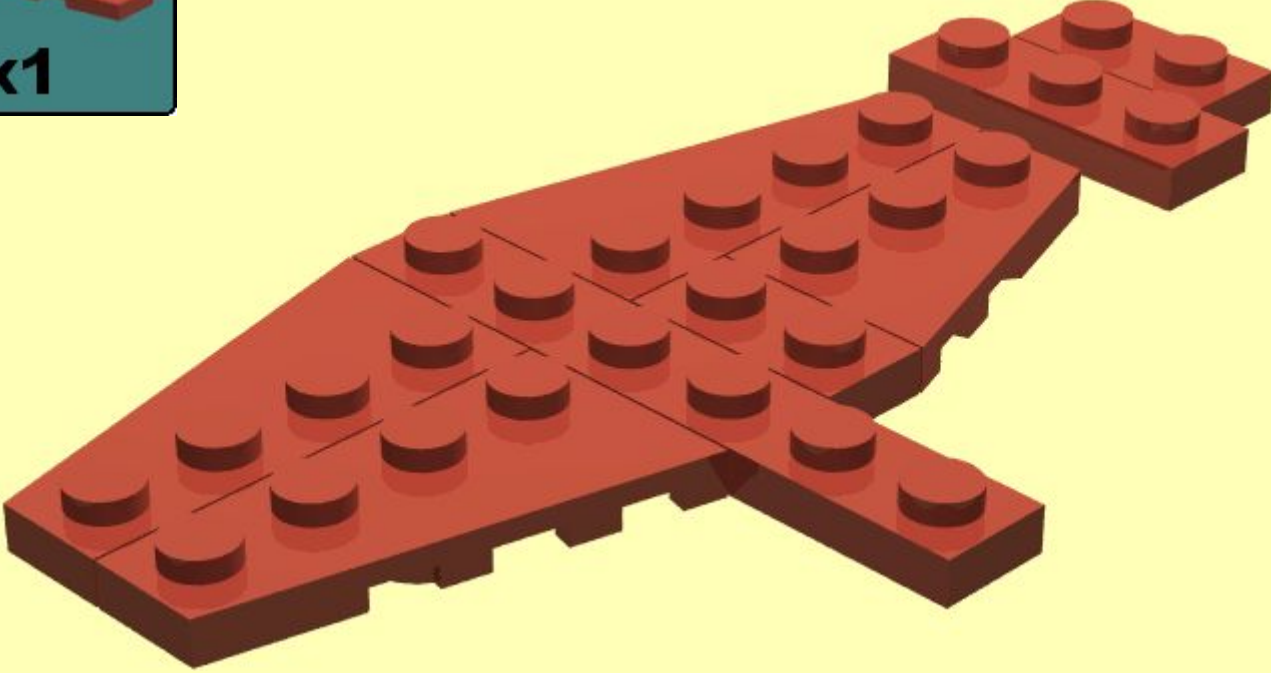

1

	
x2	x2
	
x1	x1
	
x1	x1



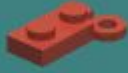



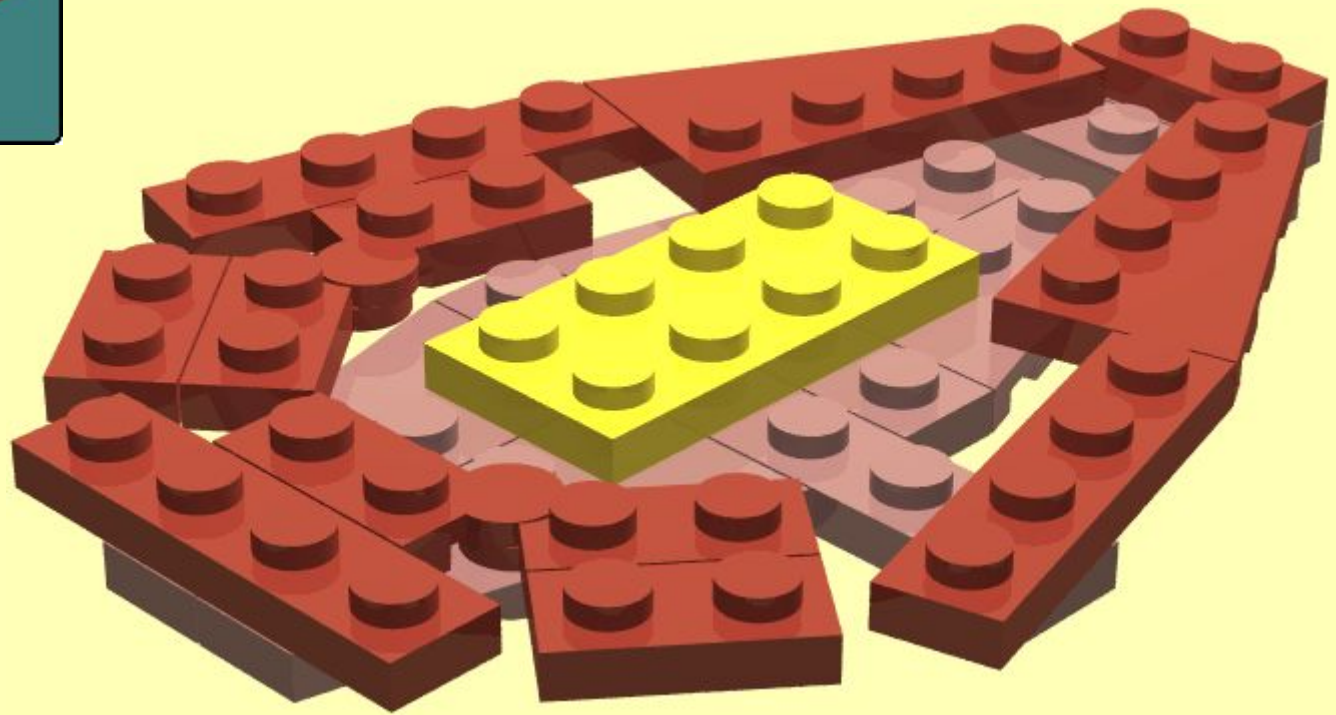

2

	
x1	x3
	
x1	x2
	
x1	x2
	
	x3

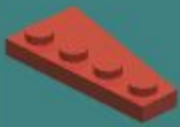





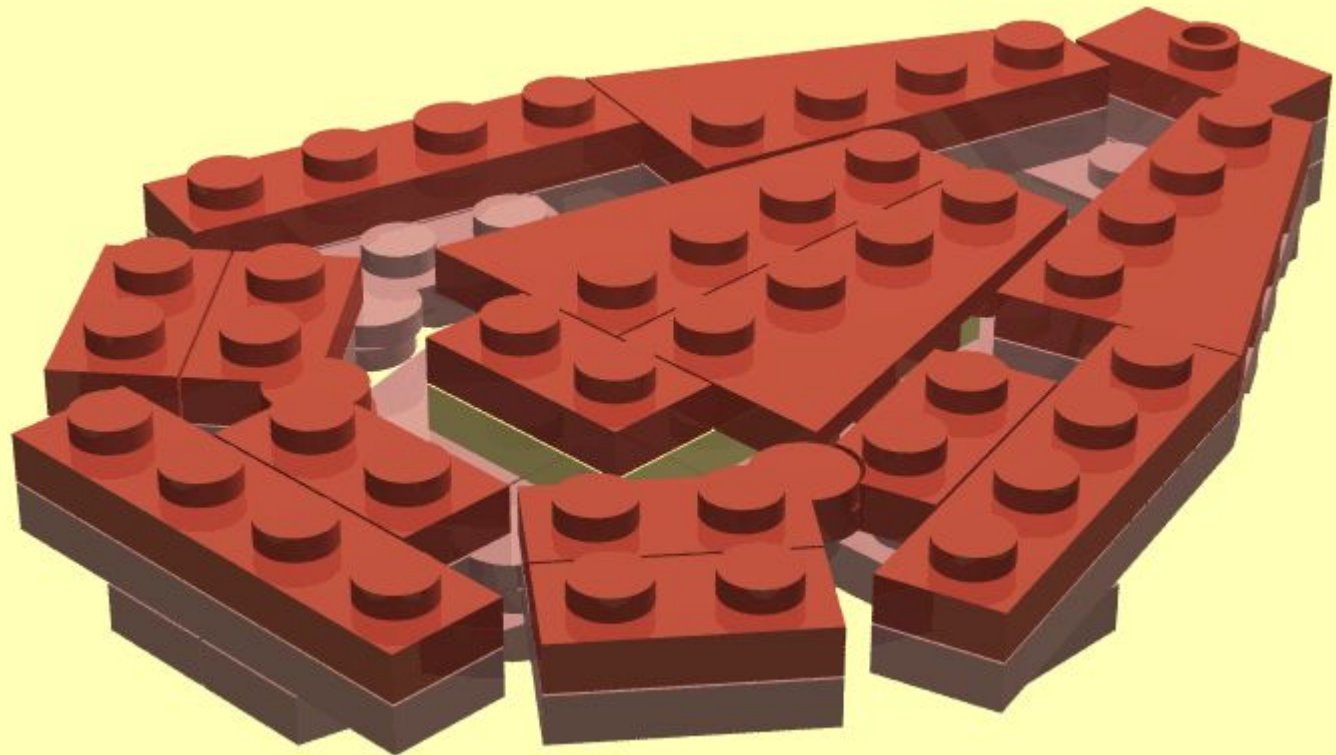

3

	x1		x1
x3			x3
	x2		x2
	x2		x2

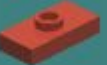





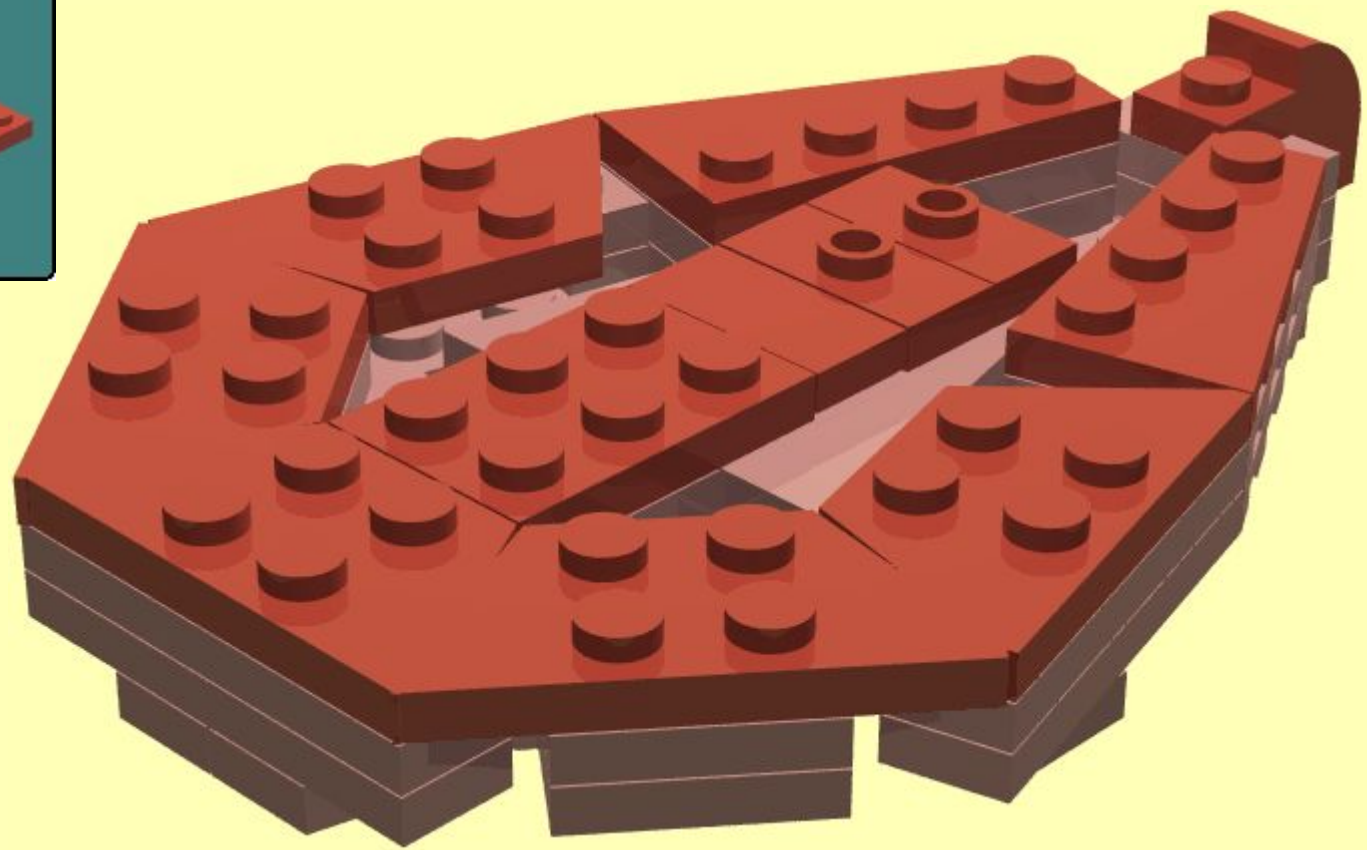

4

	
x5	x1
	
x1	x2
	
x1	x1
	
x1	x1

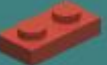

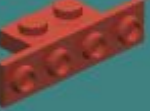
5

	
x1	x2
	
x1	x2
	
x1	x1
	
	x1

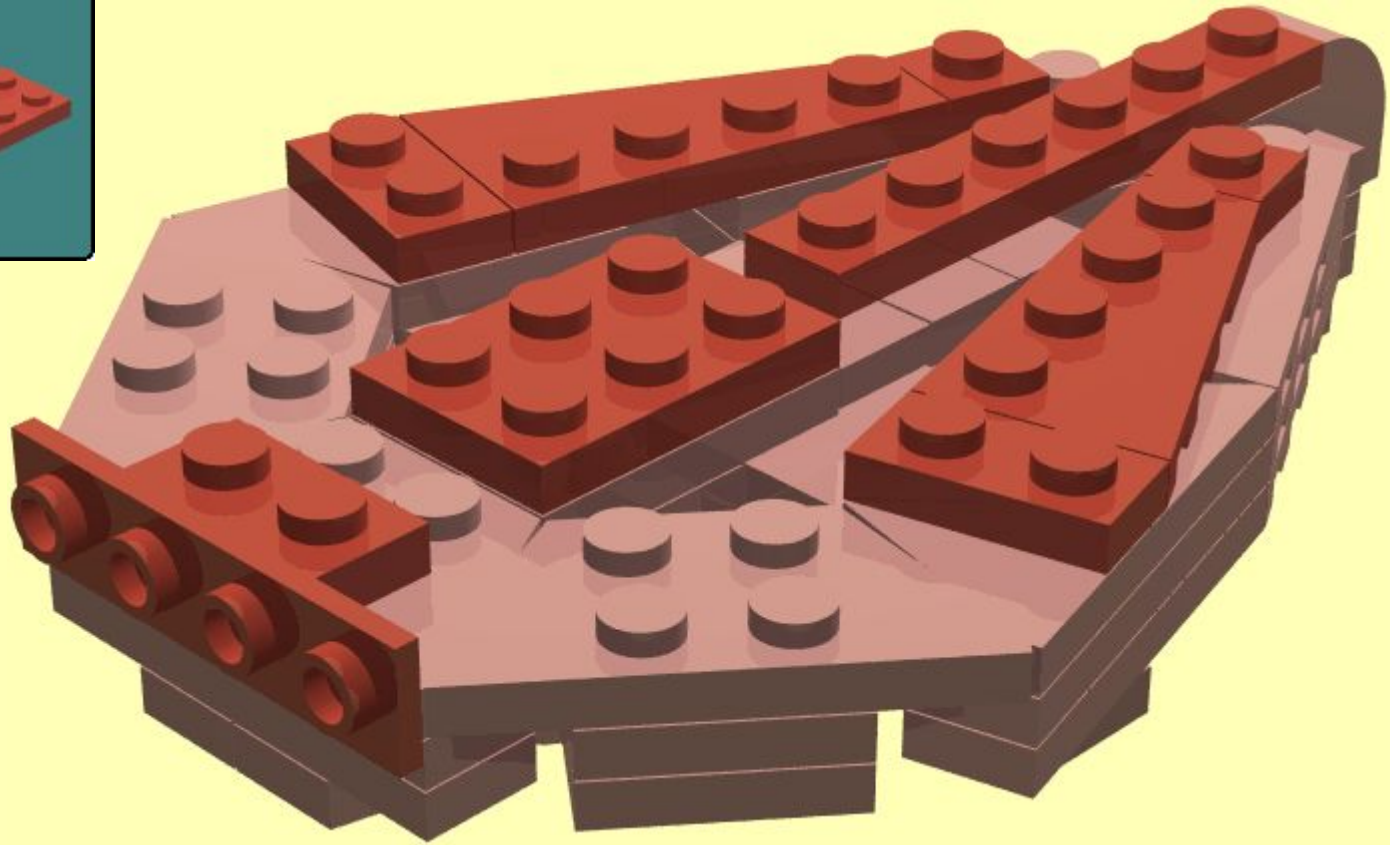

7

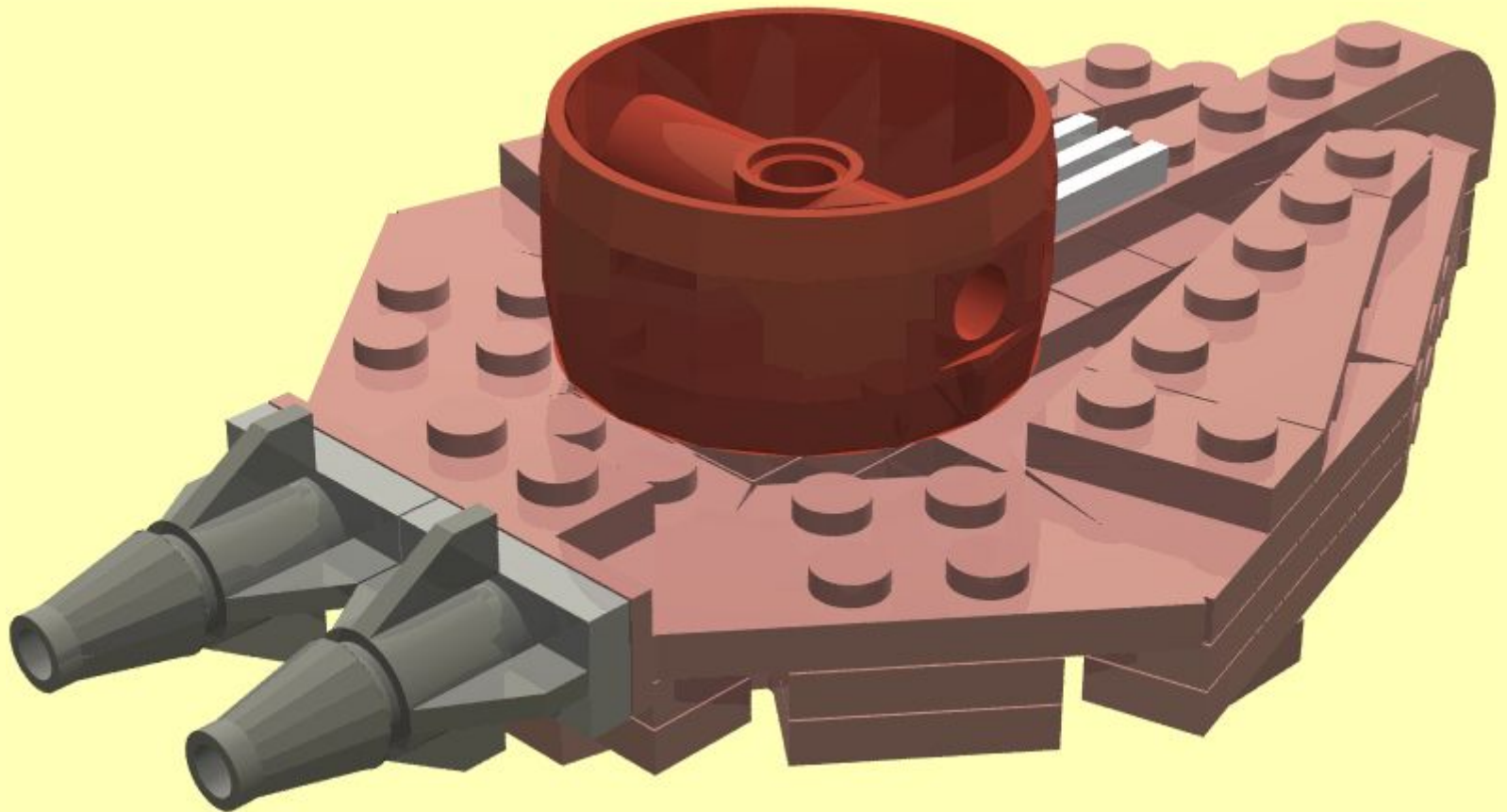



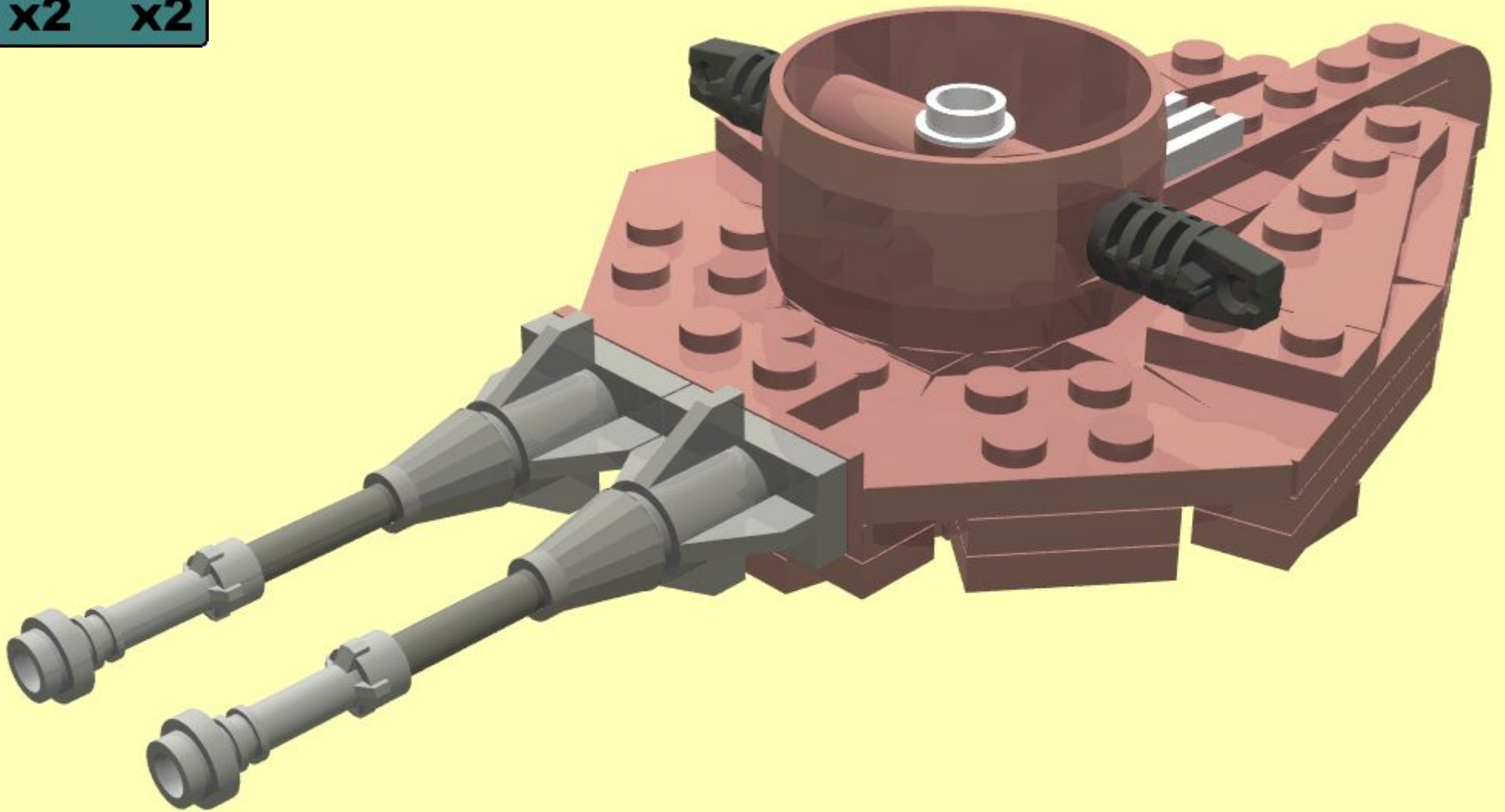
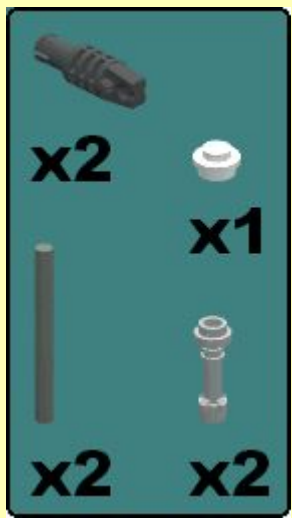

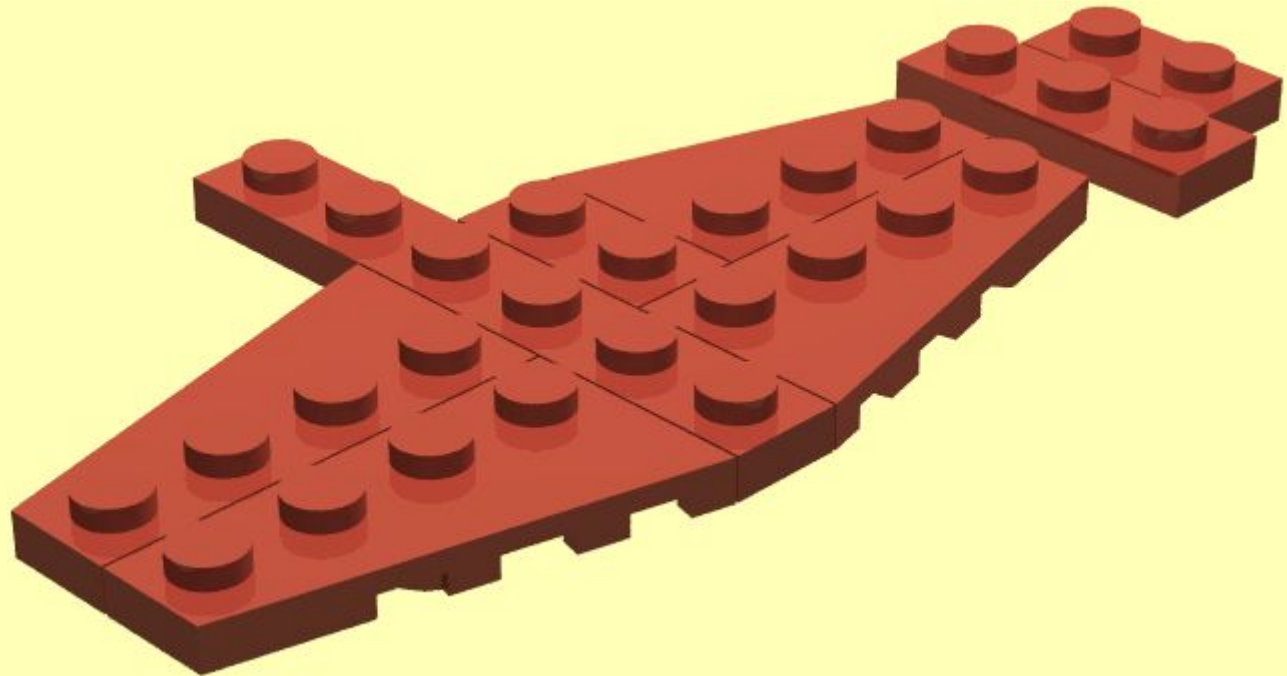
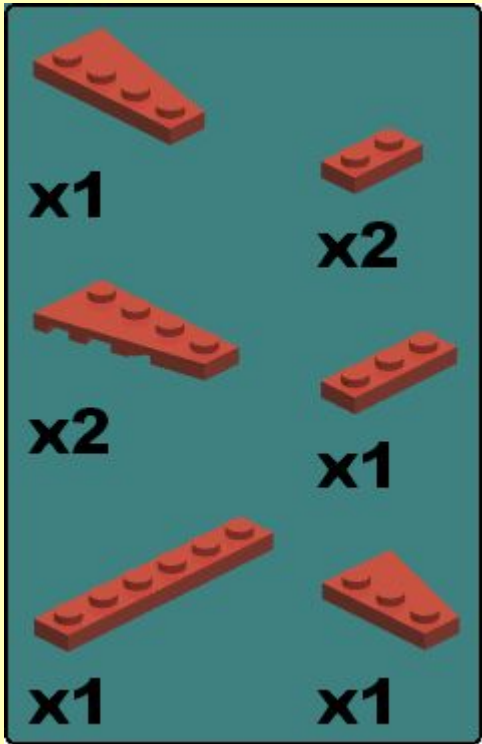

8



1





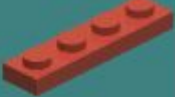

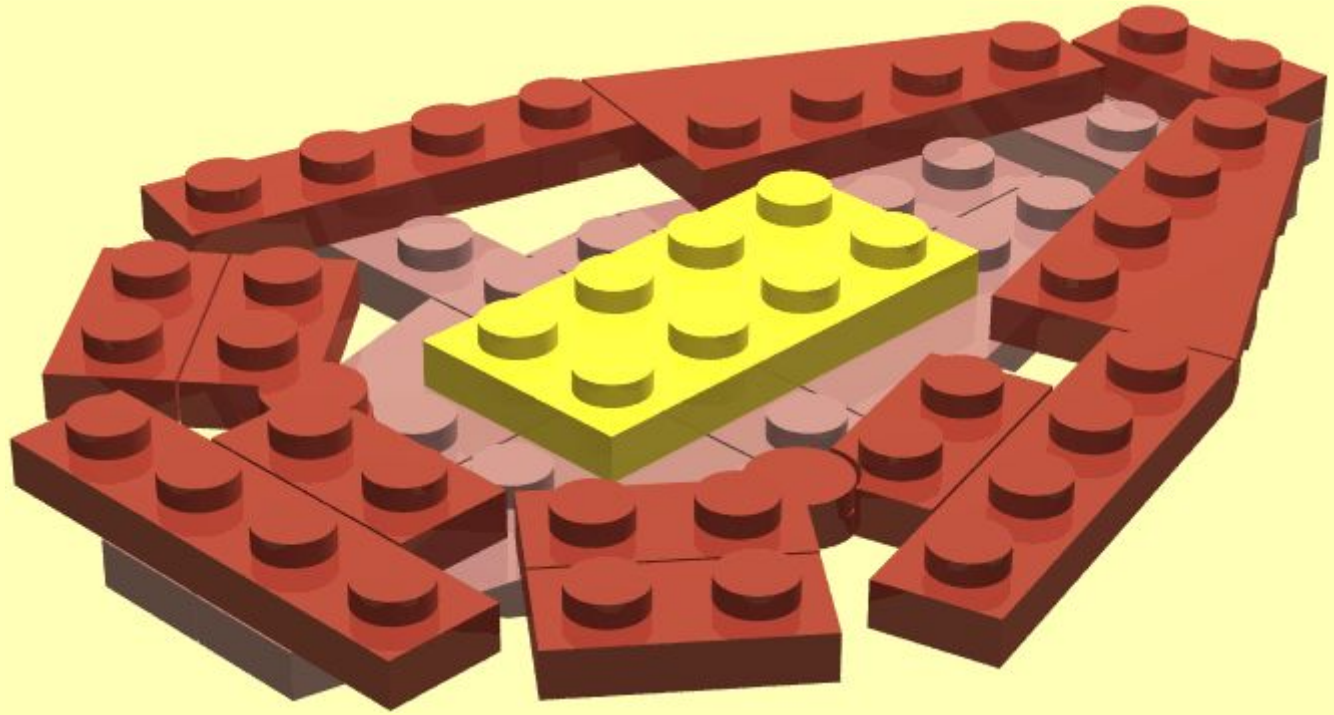

2

	
x1	x3
	
x1	x2
	
x1	x2
	
	x3







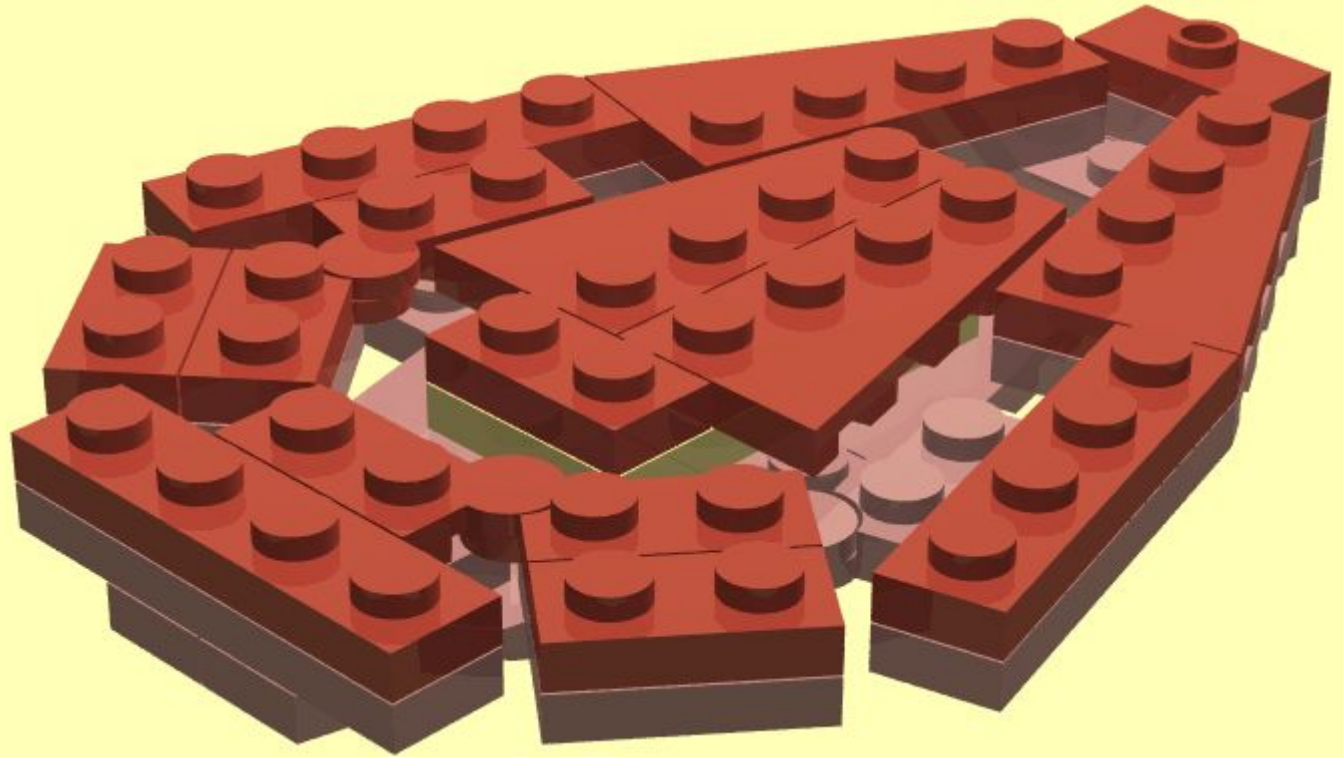



3

	x1		x1
x3			x3
	x2		x2
	x2		x2







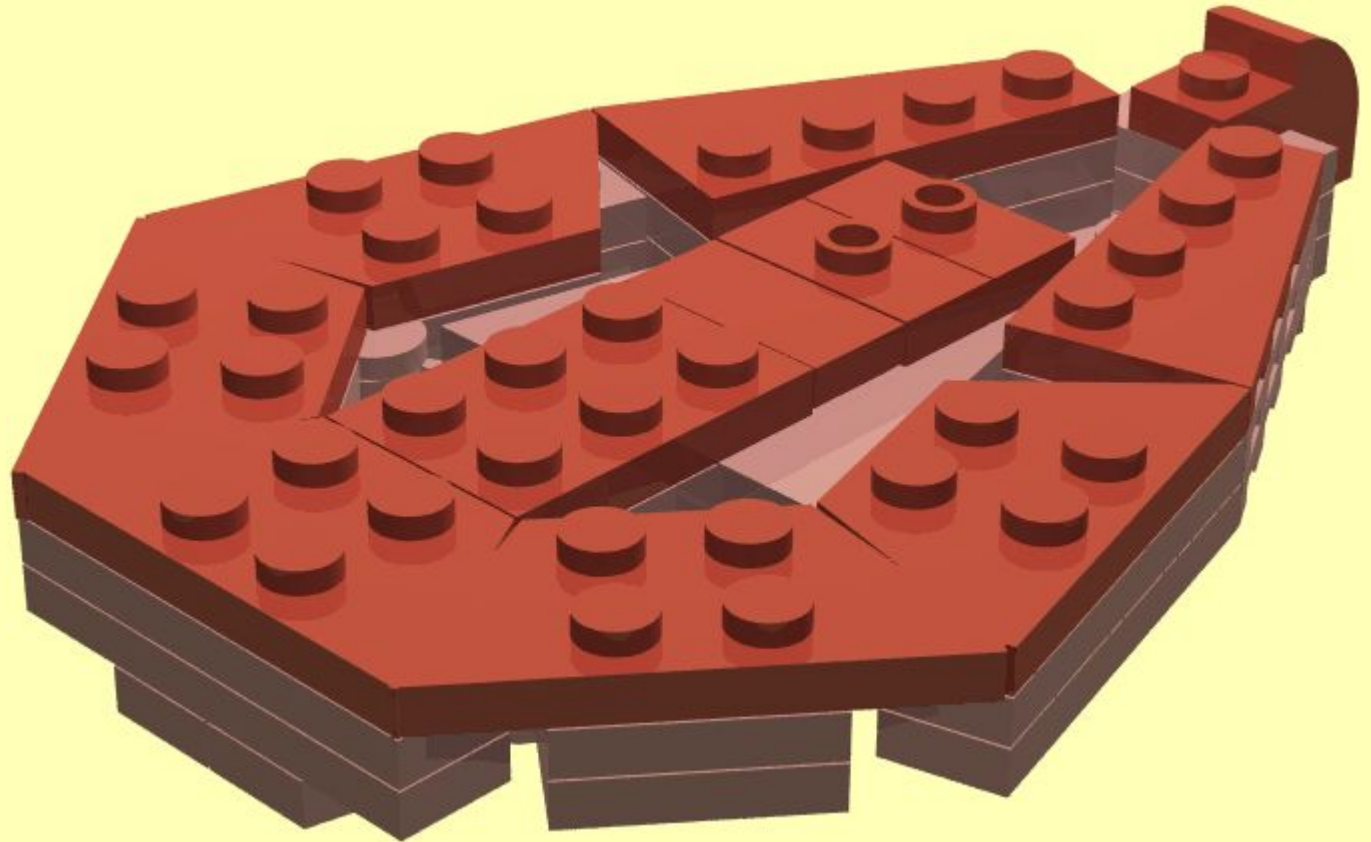

4

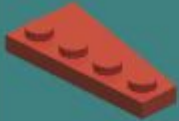
	
x5	x1
	
x1	x2
	
x1	x1
	
x1	x1

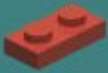

5

	
x1	x2
	
x1	x2
	
x1	x1
	
x1	x1

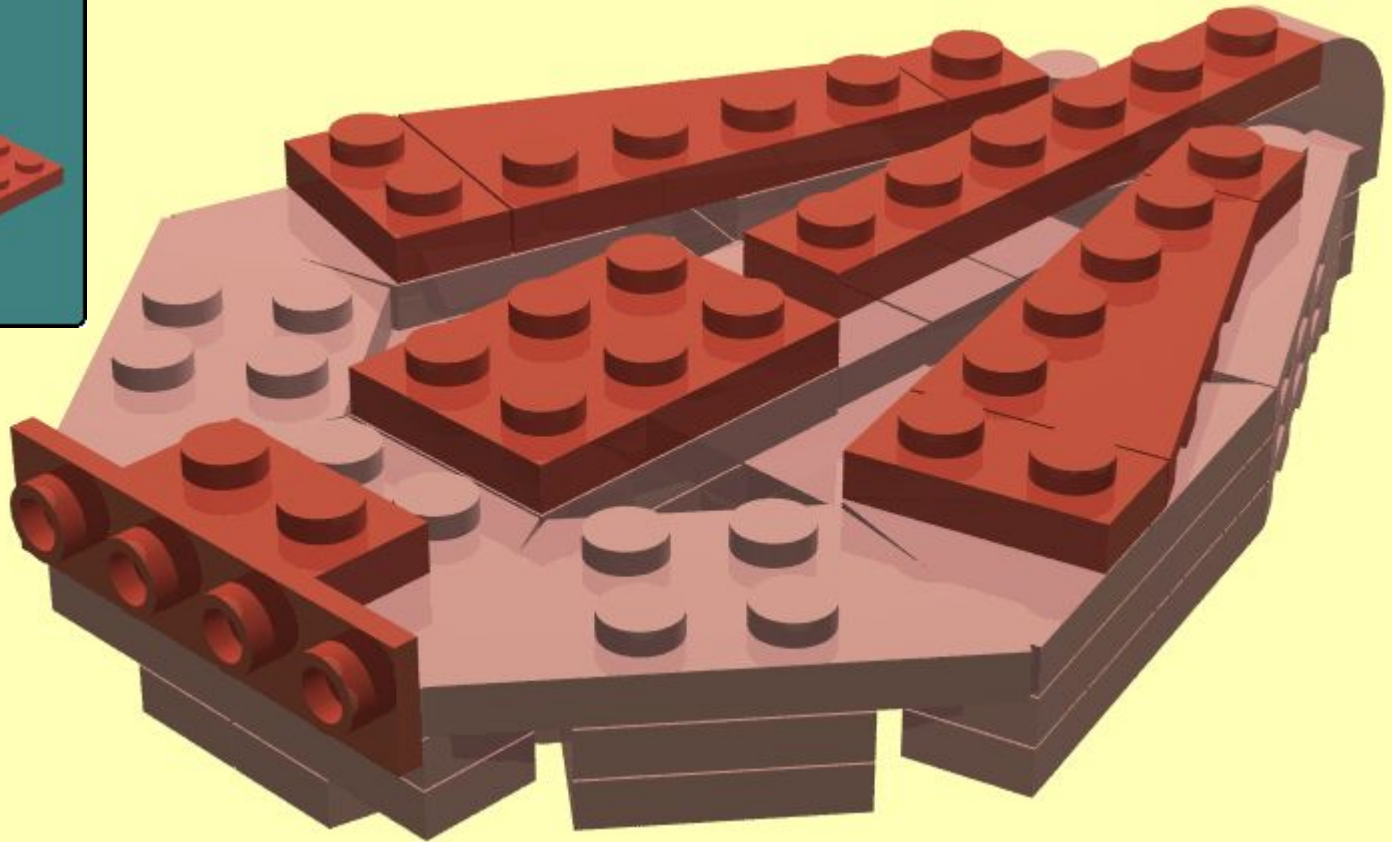

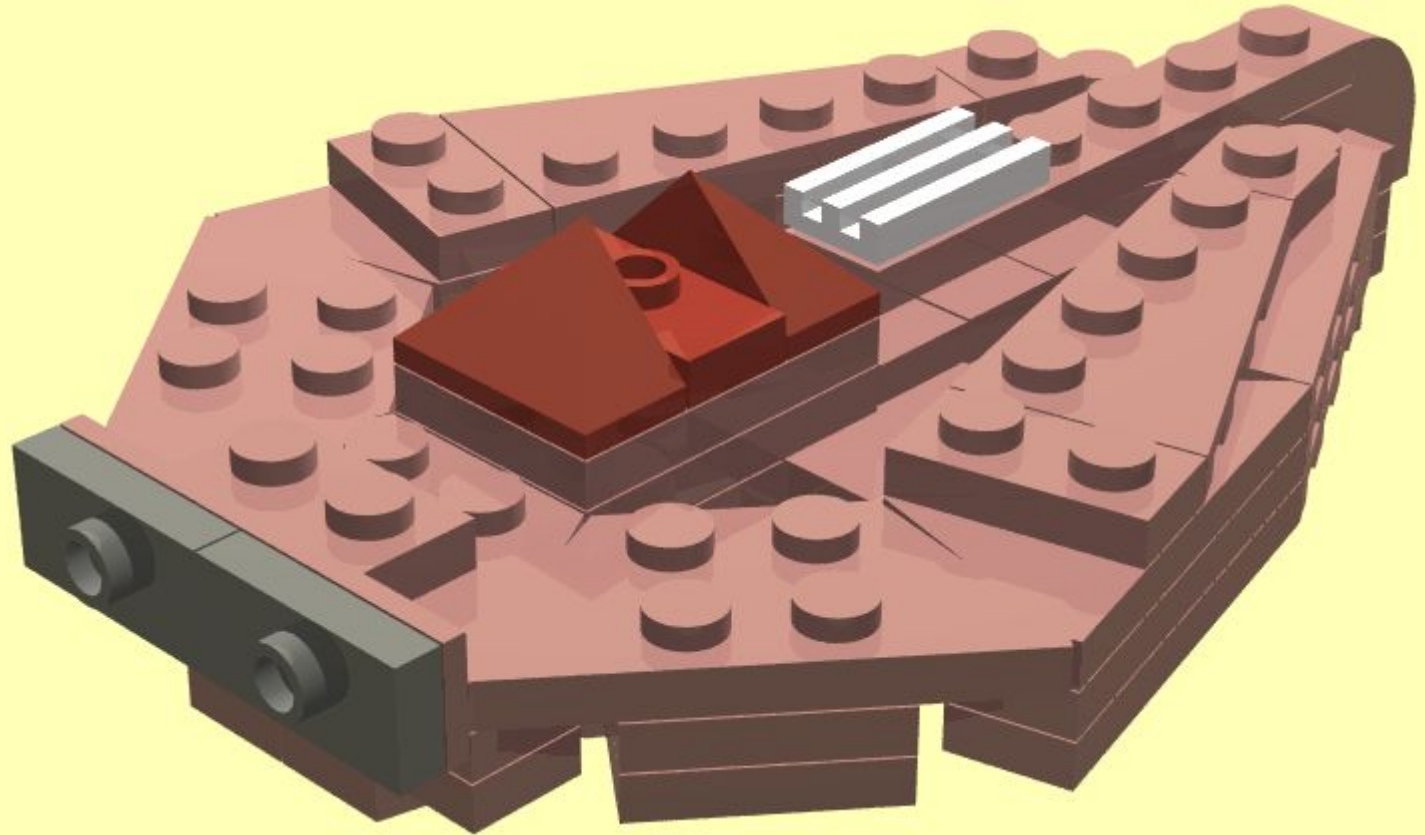
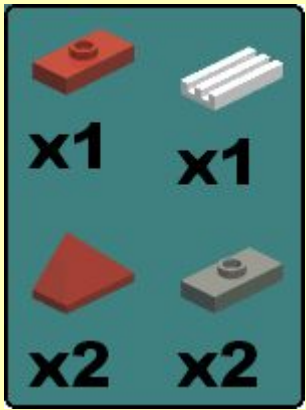

6

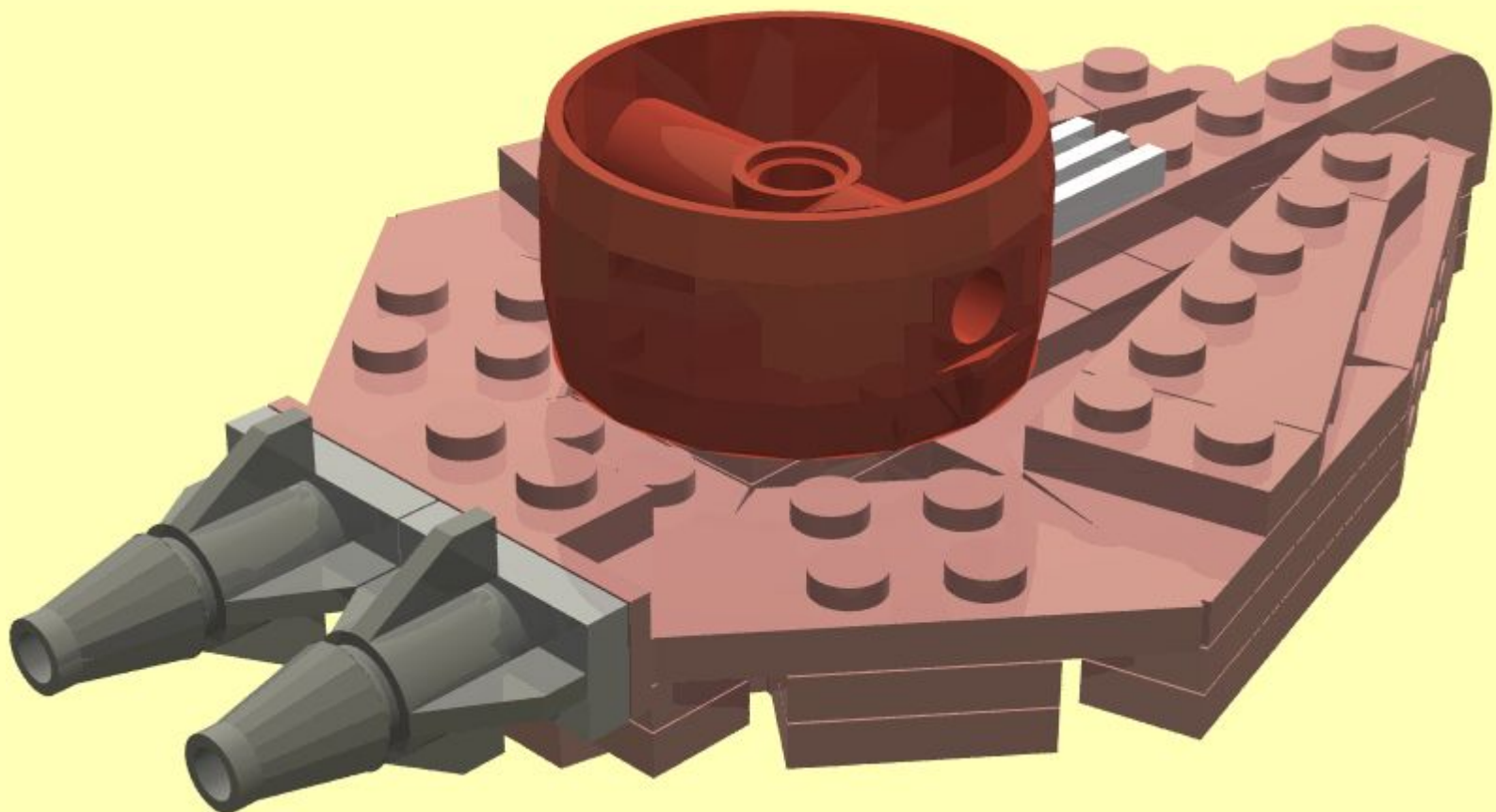

7



8

	
x2	x1
	
x2	x2

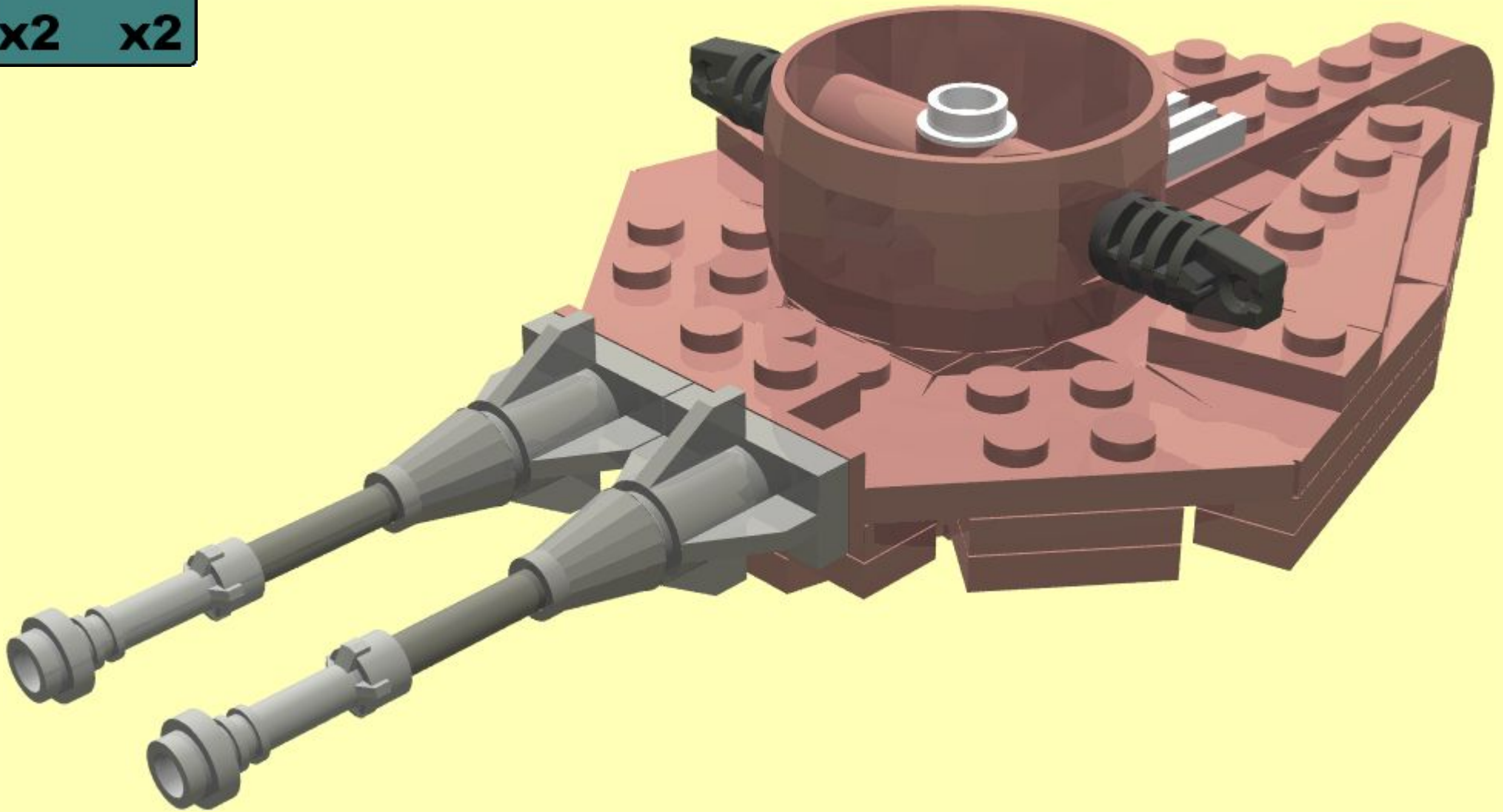

1

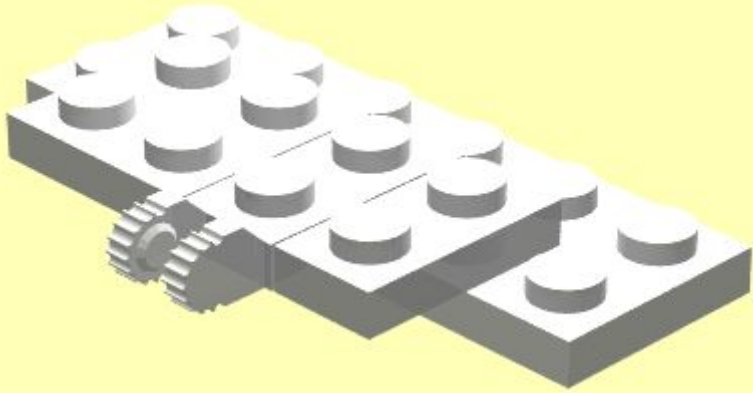
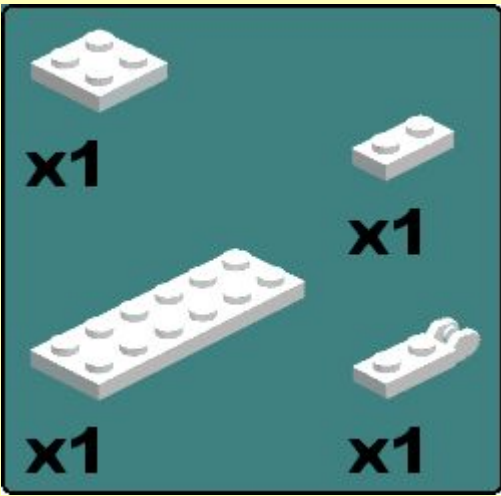

2

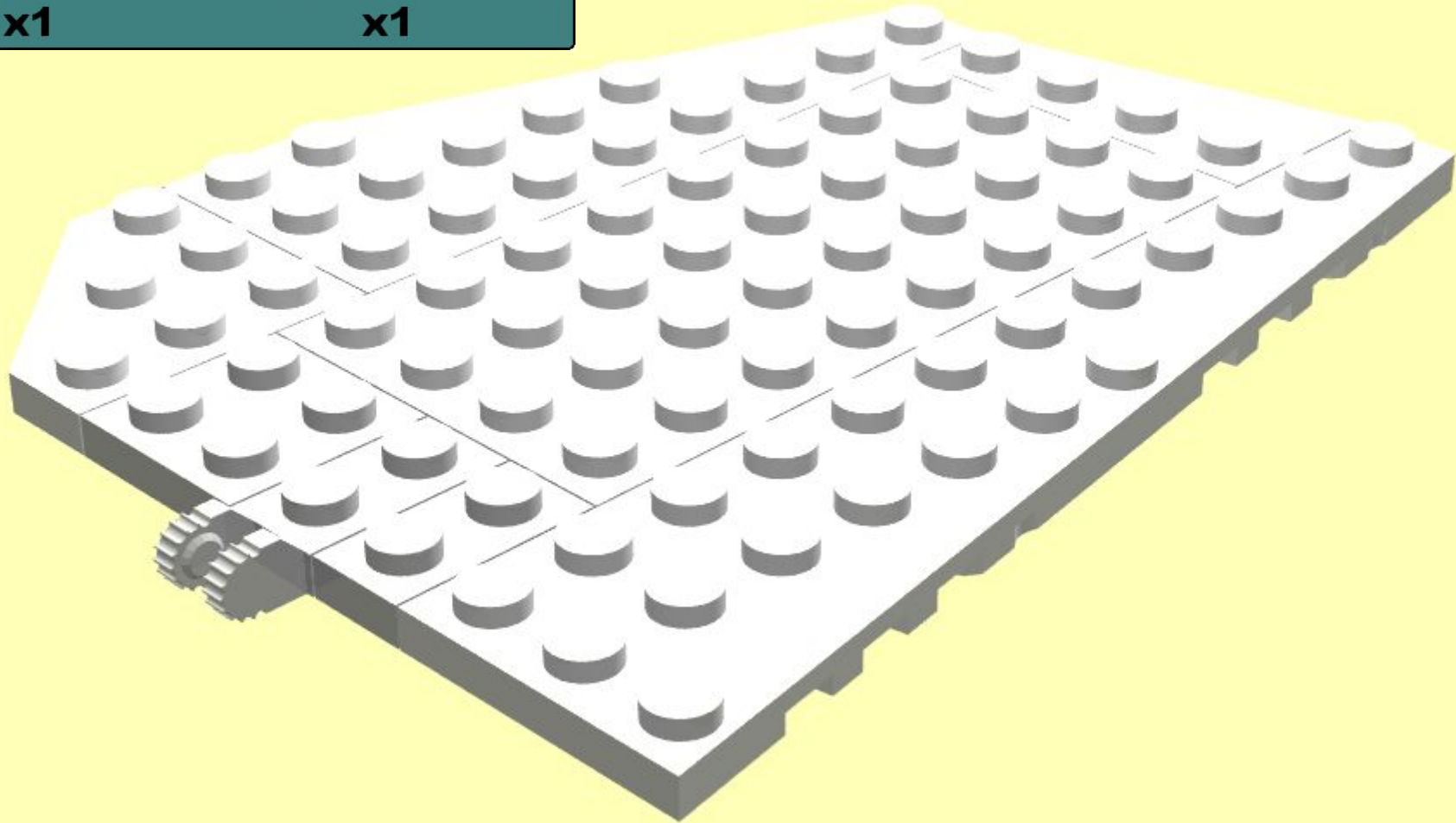
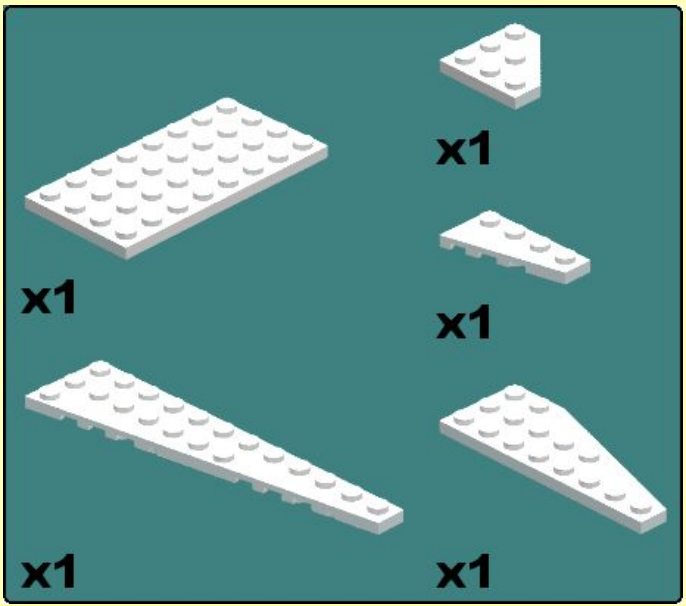

3

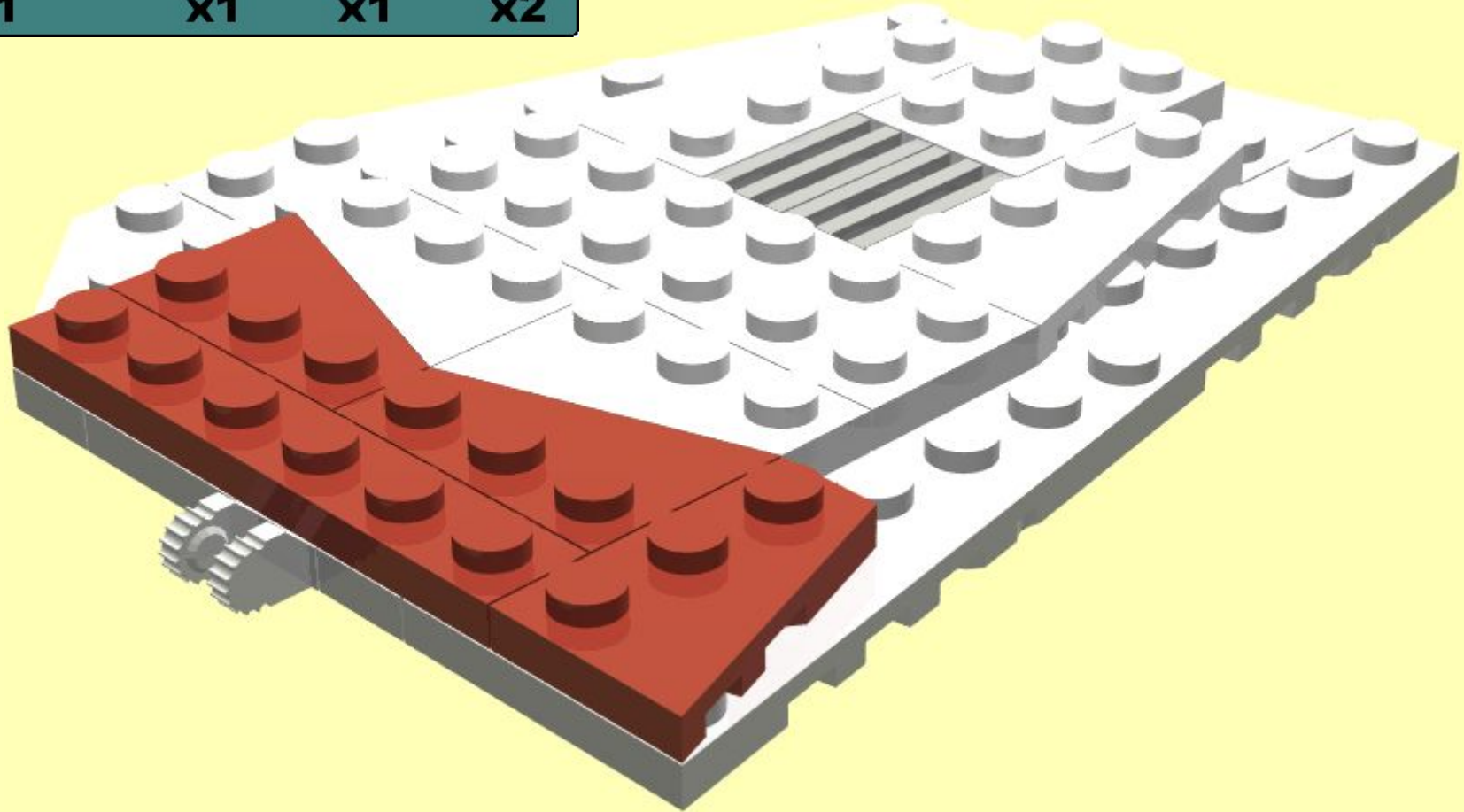
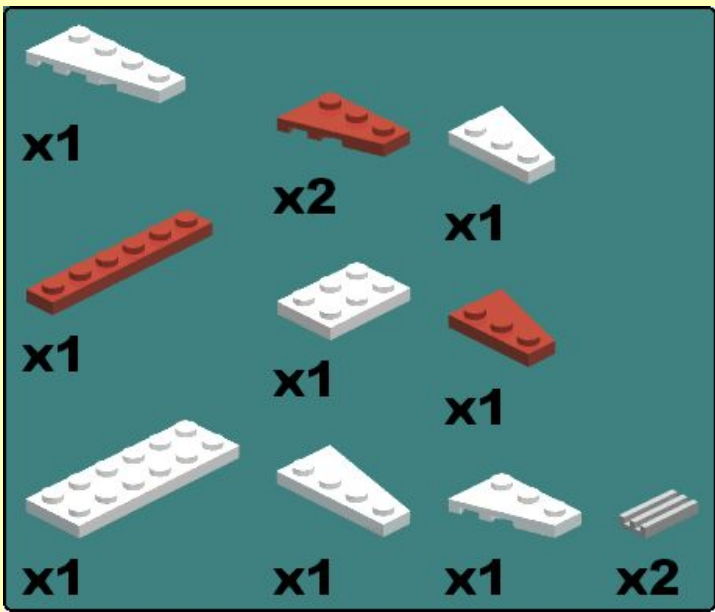

1

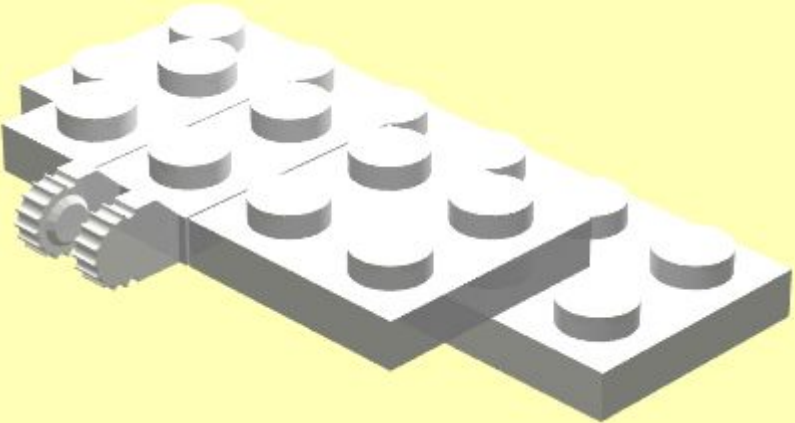
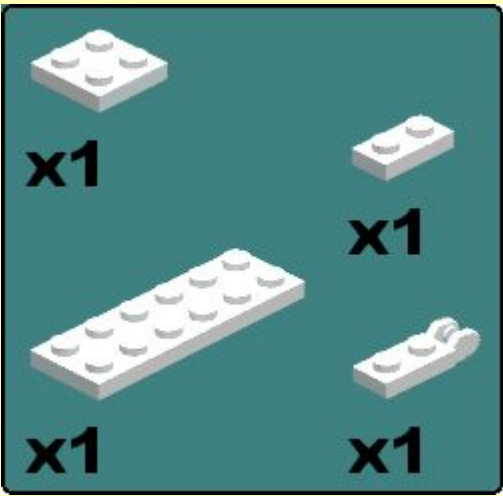

2

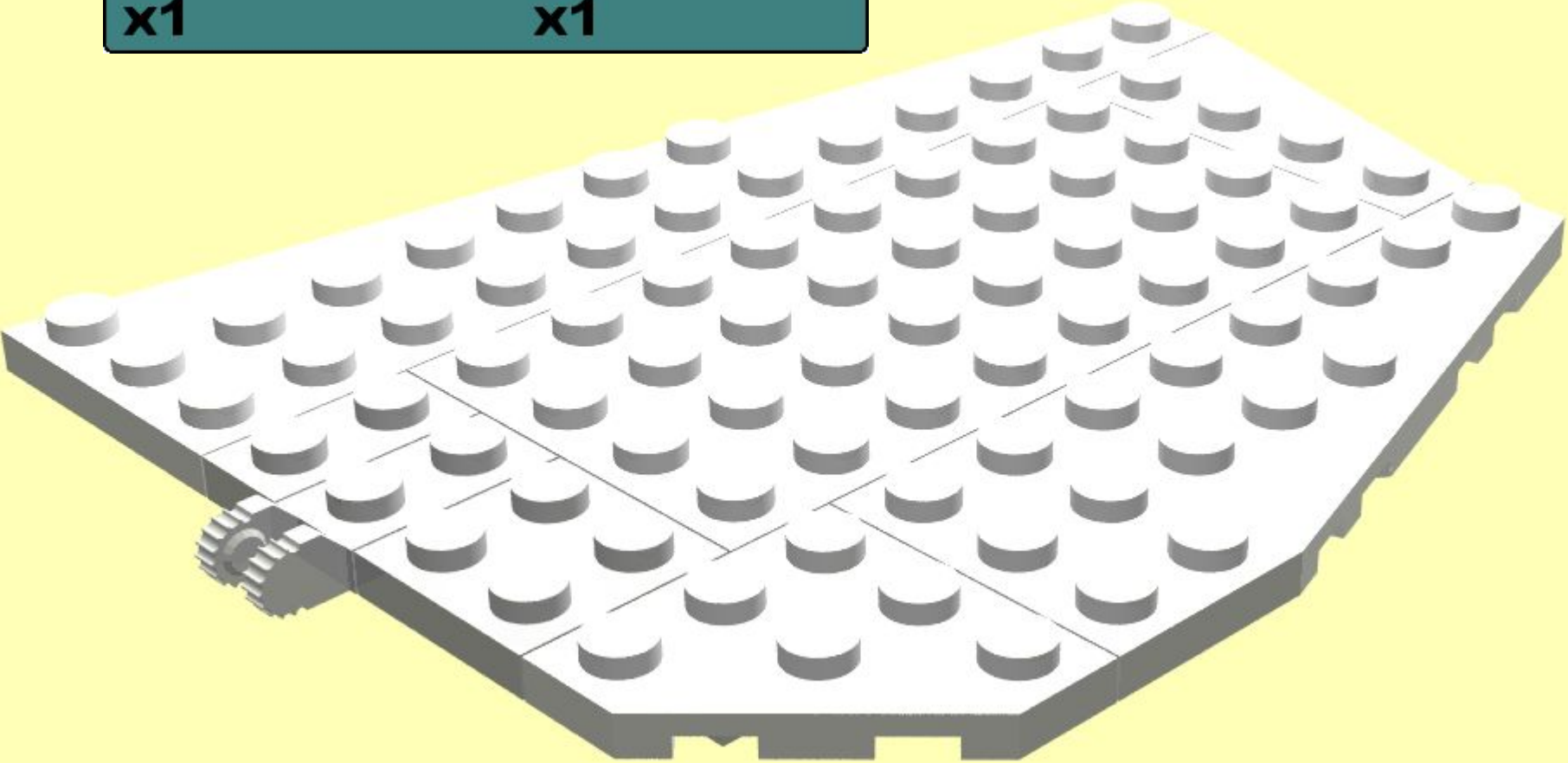
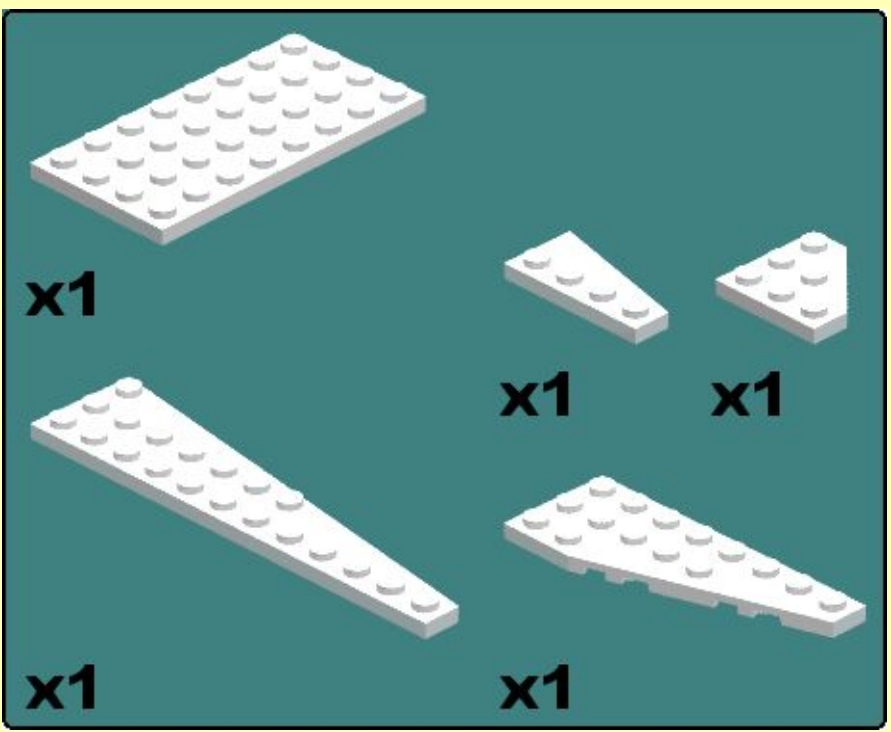

3

