

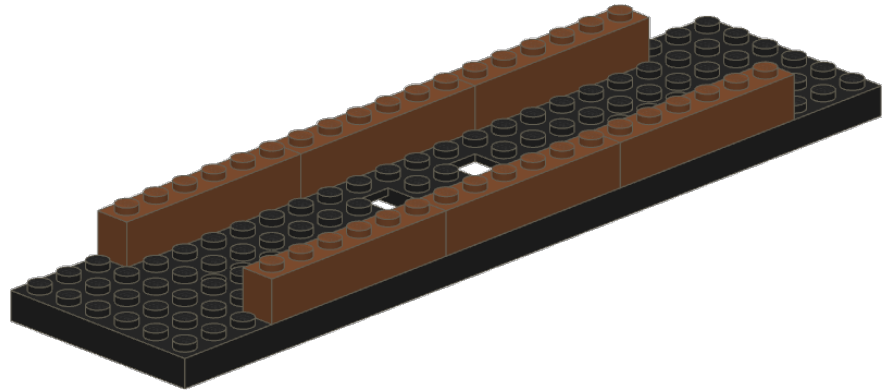

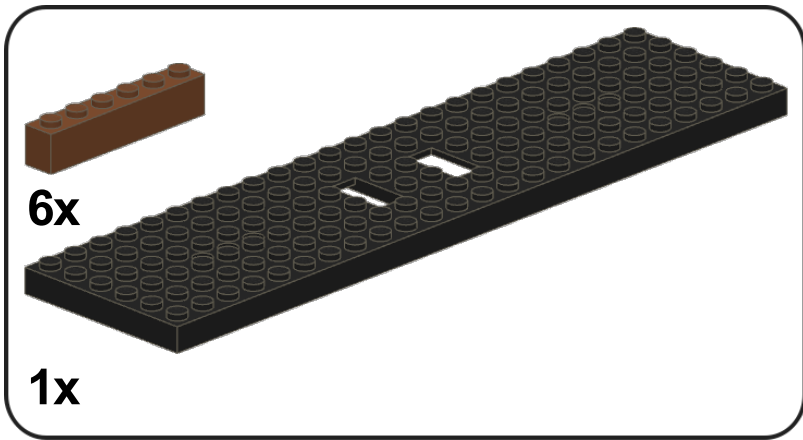

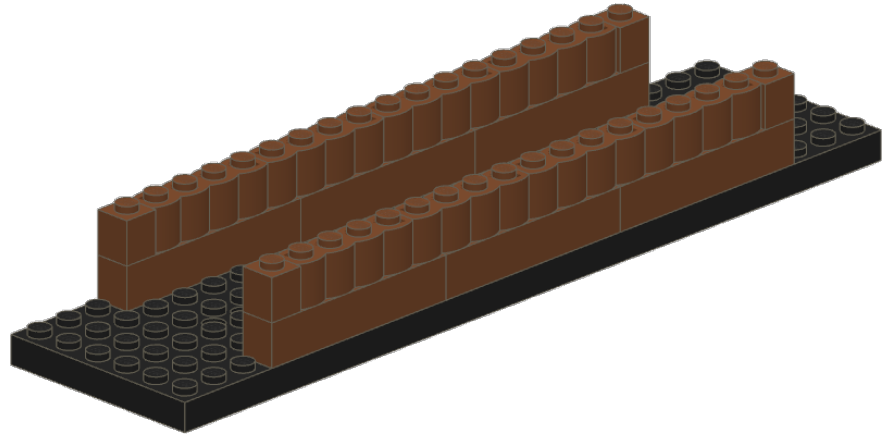

1

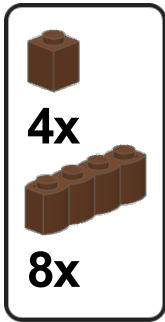





2



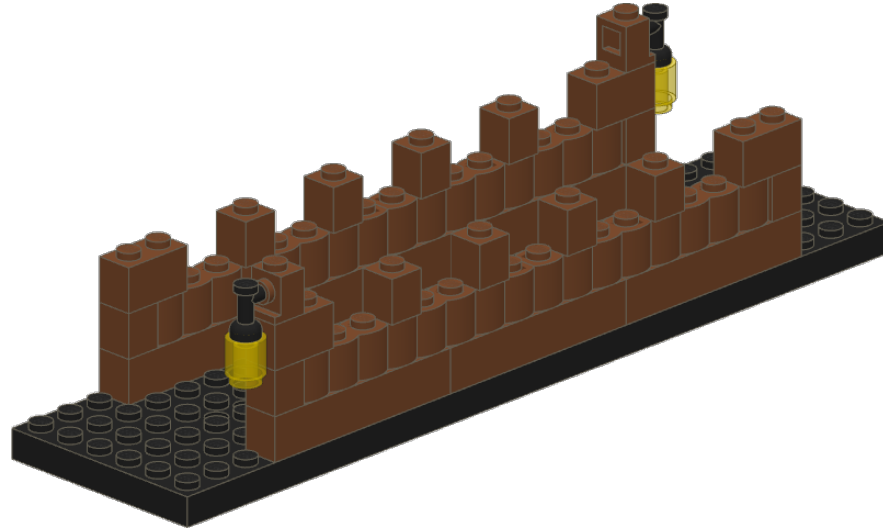

3

-  2x
-  8x
-  2x
-  4x
-  2x



- 1 
- 2   2x

4

-  10x
-  10x
-  2x

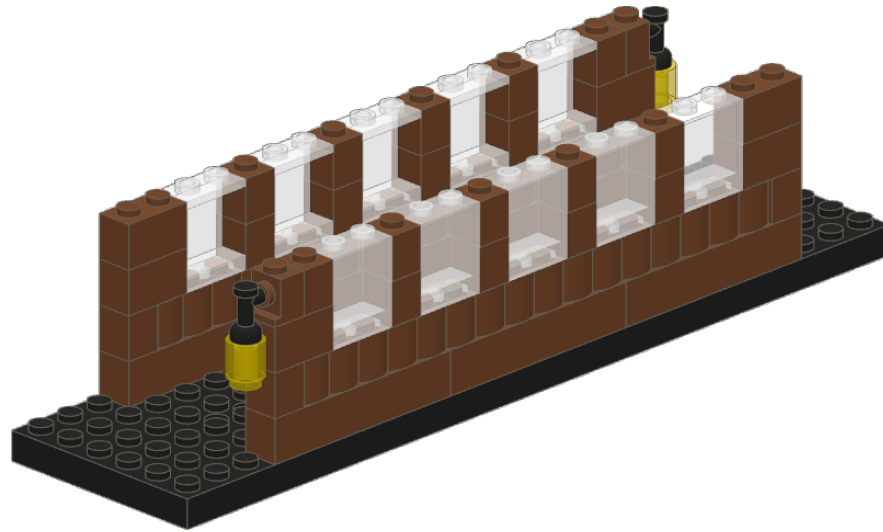

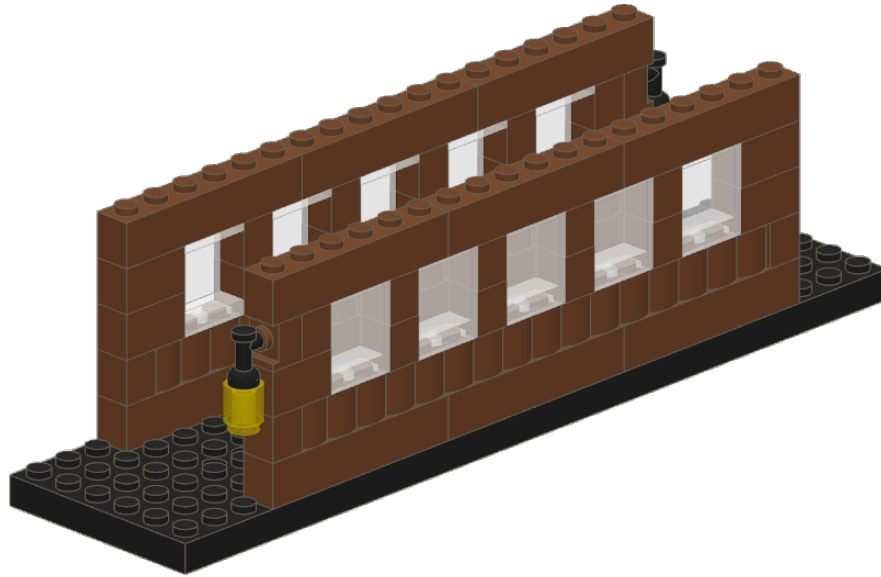
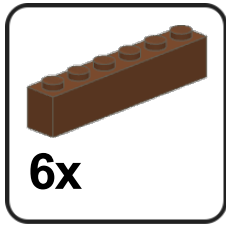

5

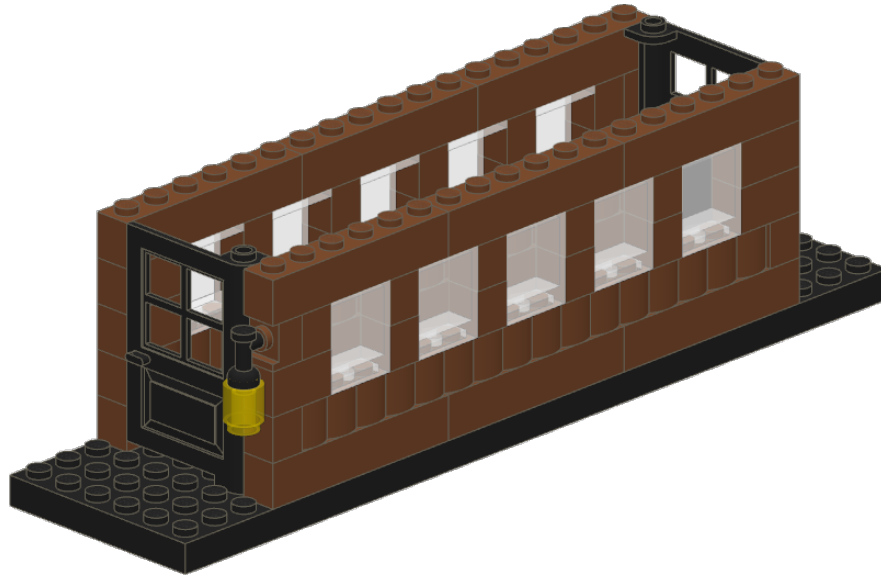
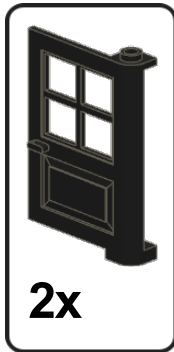

6



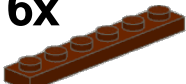

7

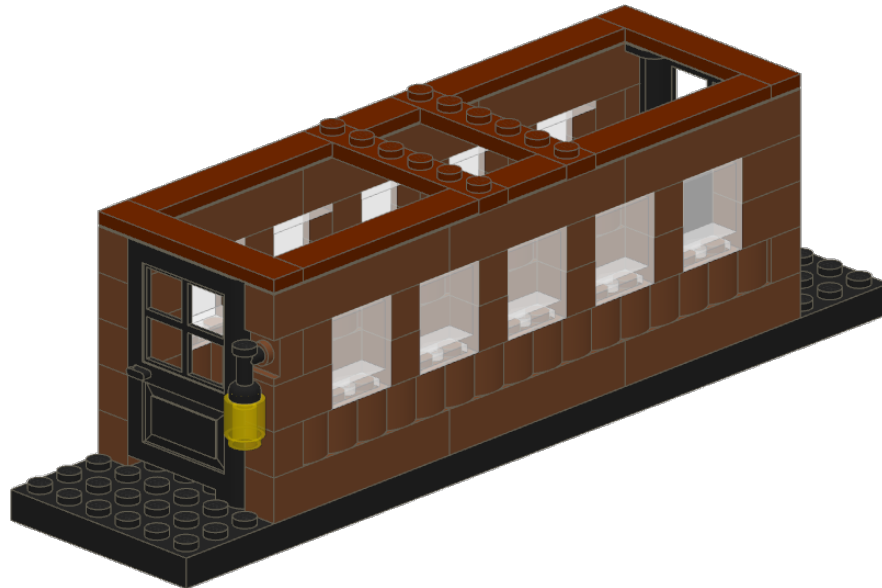
-  2x
-  6x
-  2x



8

-  2x
-  2x
-  4x

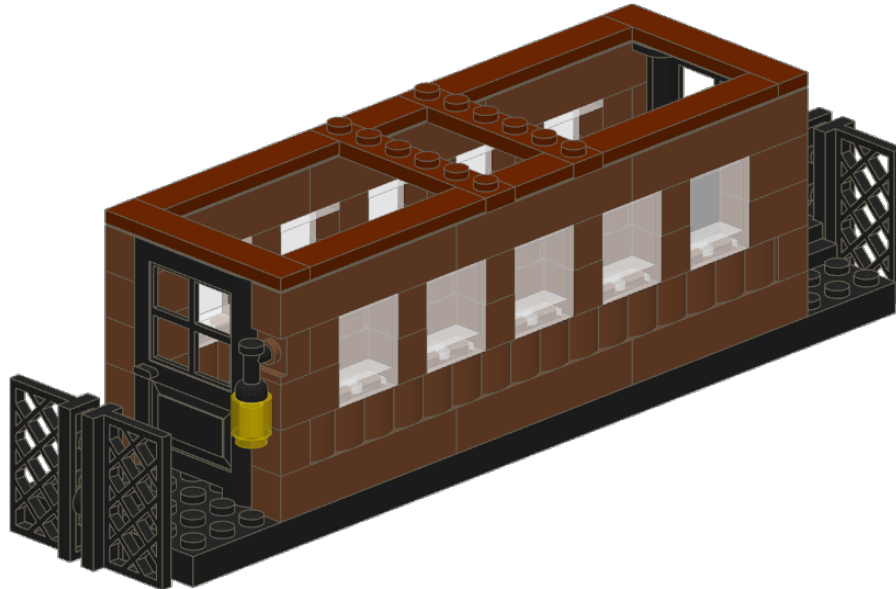

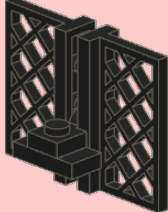
- 1 
- 2  2x

9



1x



2x



1x

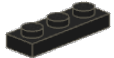

1x

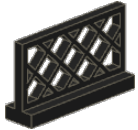

2x



2x

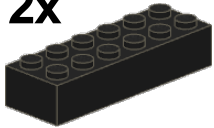

1x

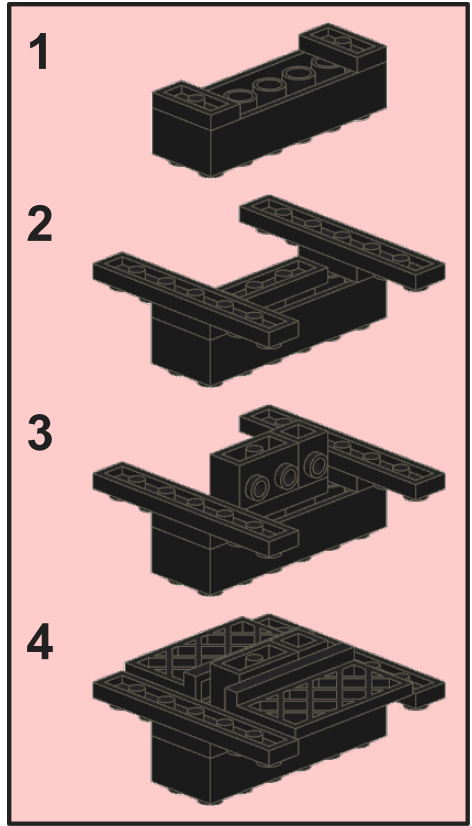
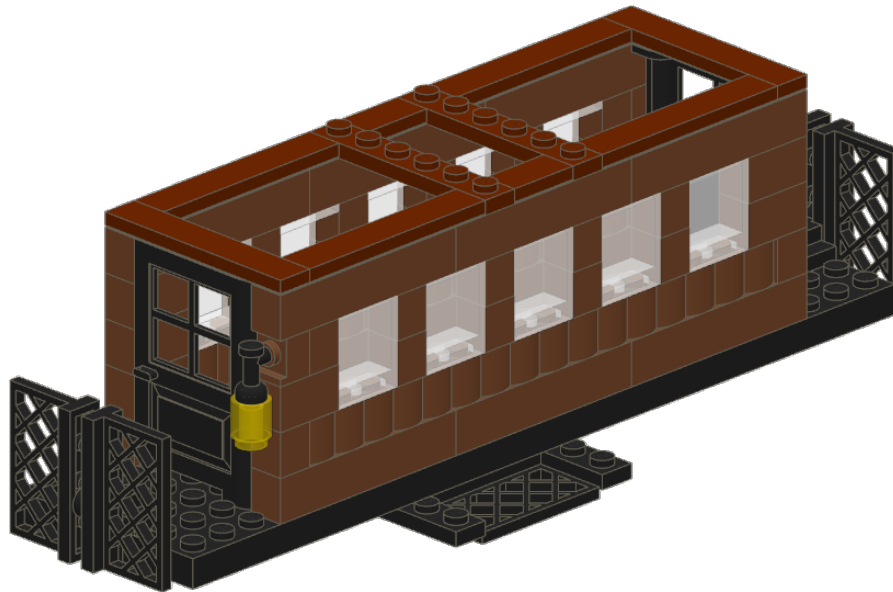

1

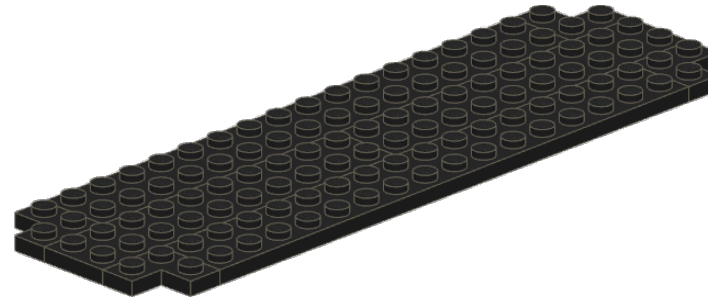
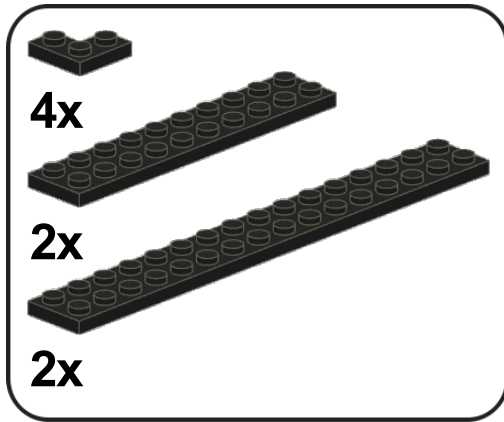

2

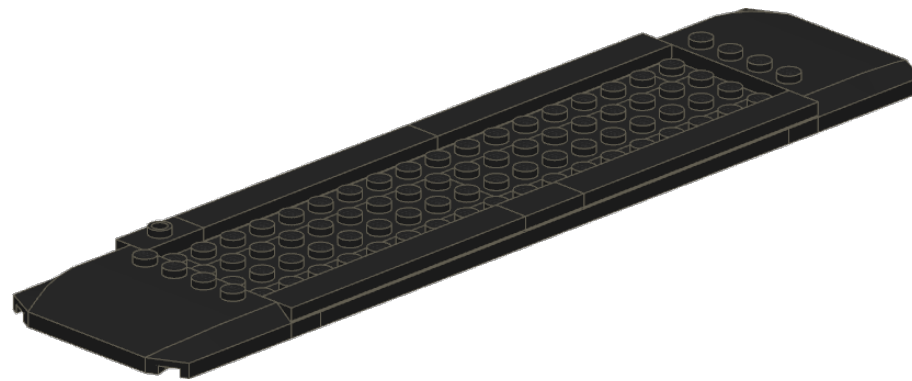
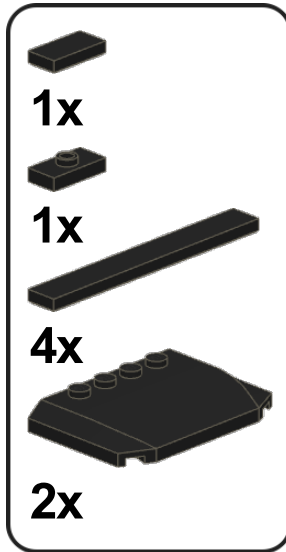

3

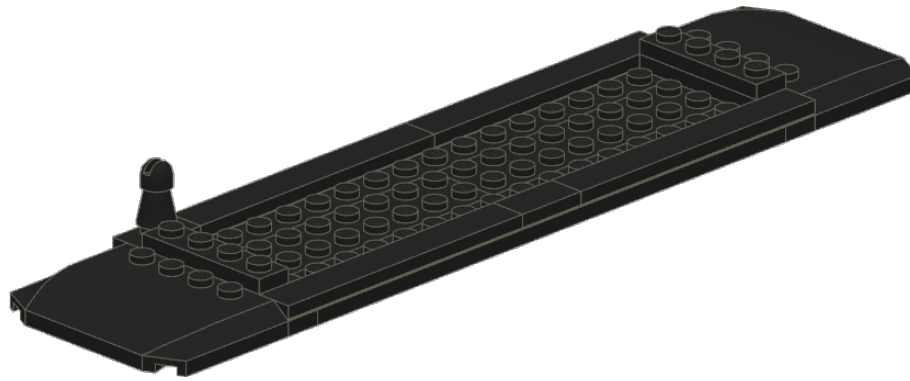
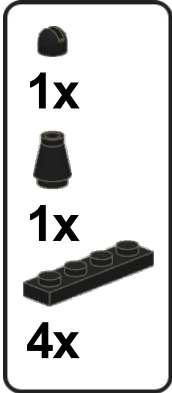

4

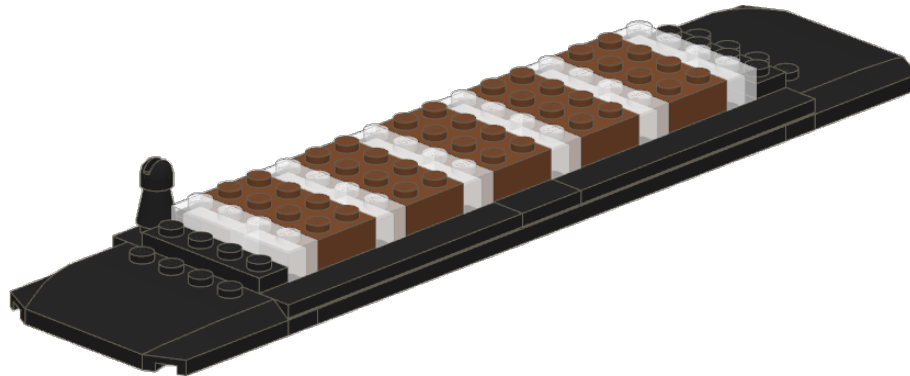
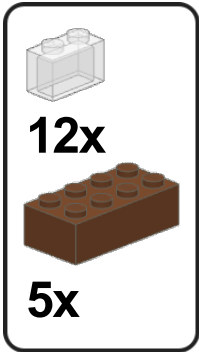

5

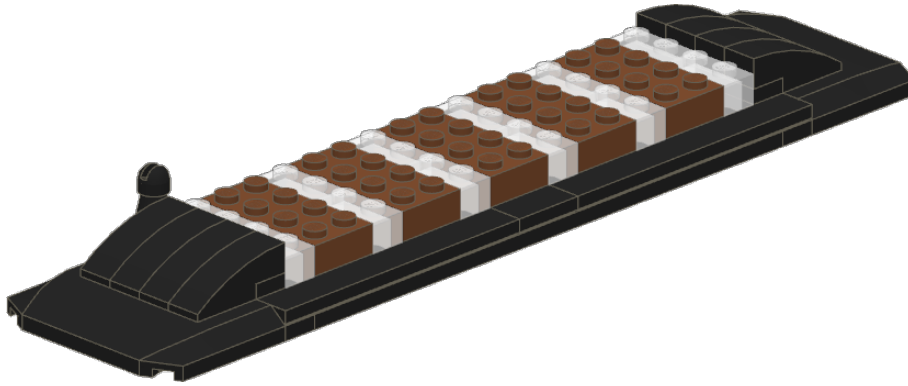
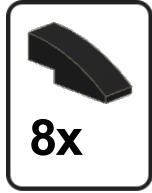

6

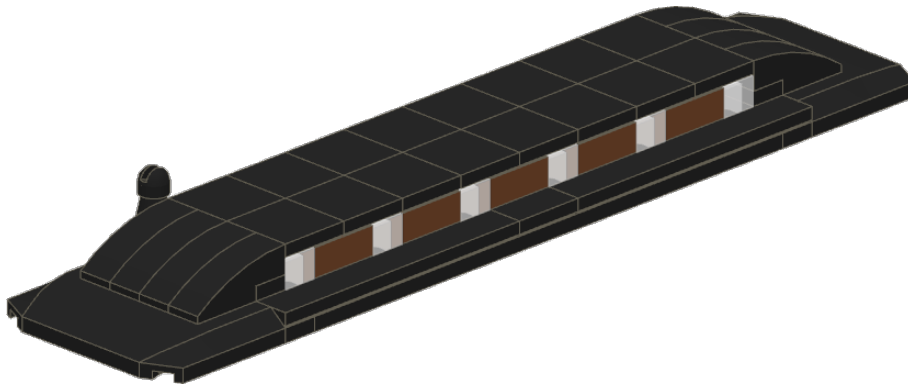
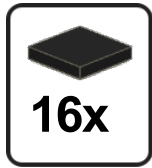

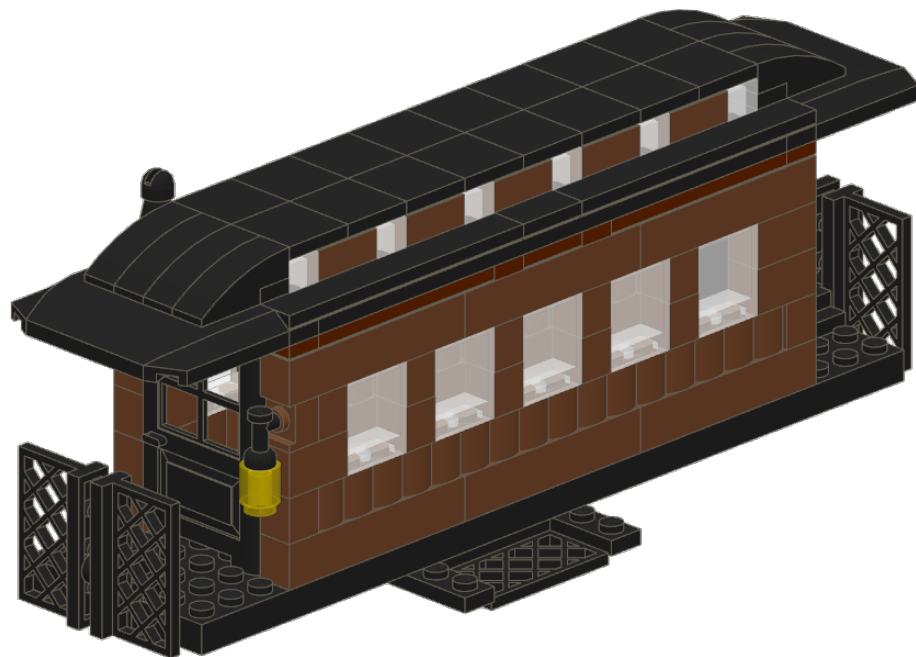

1

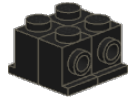

2

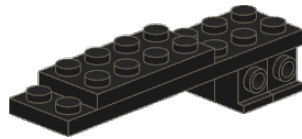
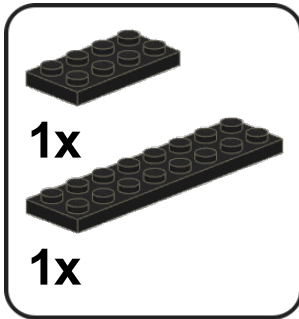

3

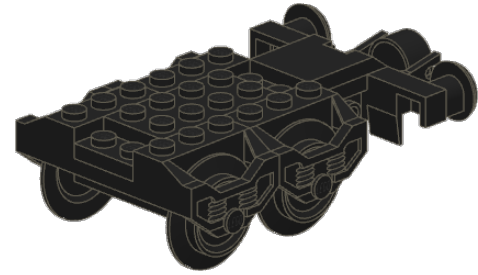
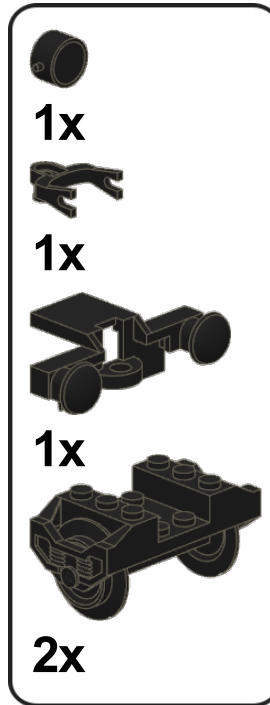

4

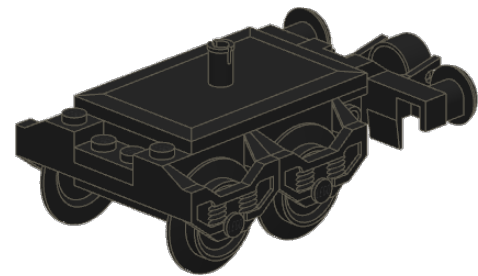
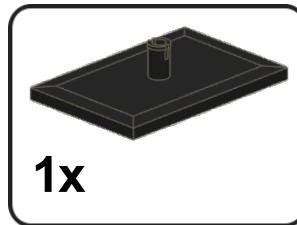

5

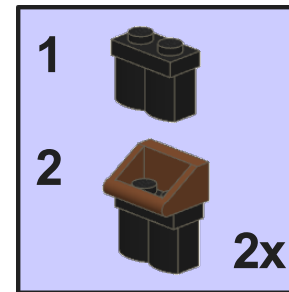
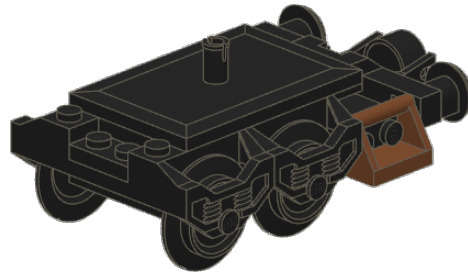
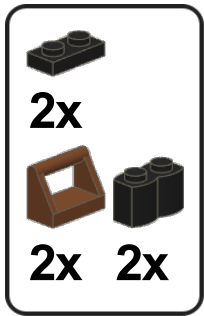

1

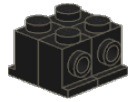

2

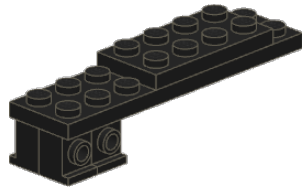
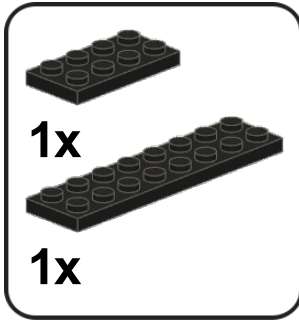

3

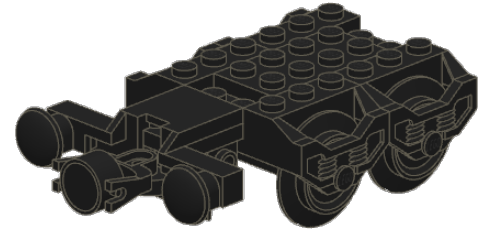
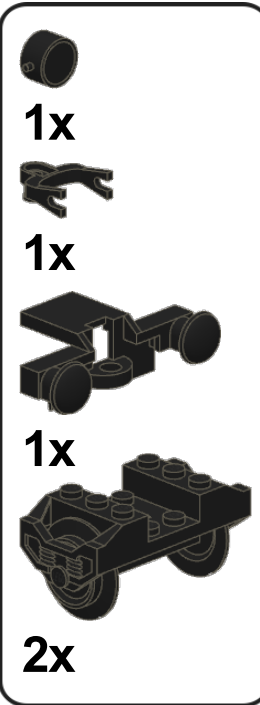

4

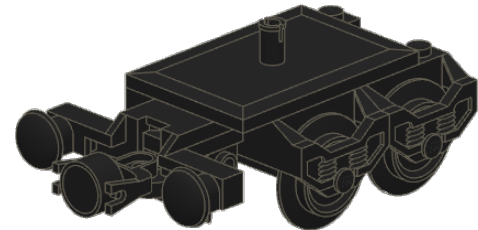
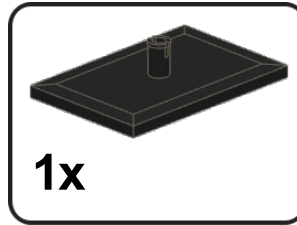

5

