



x3















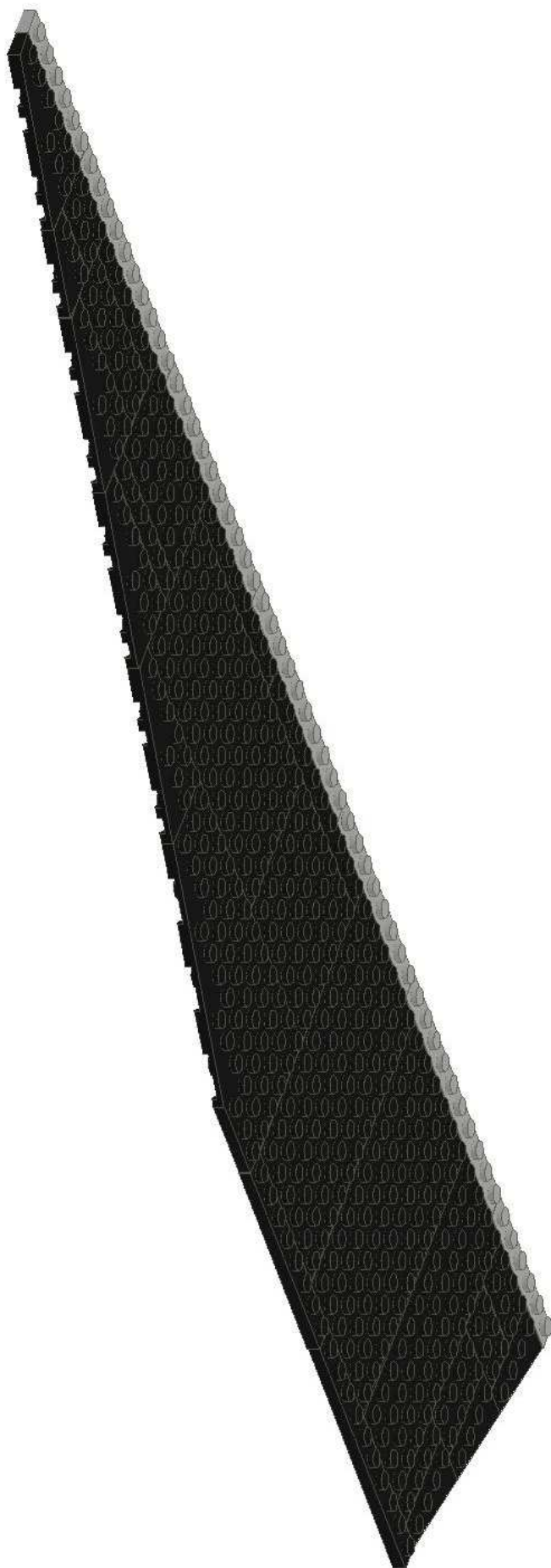

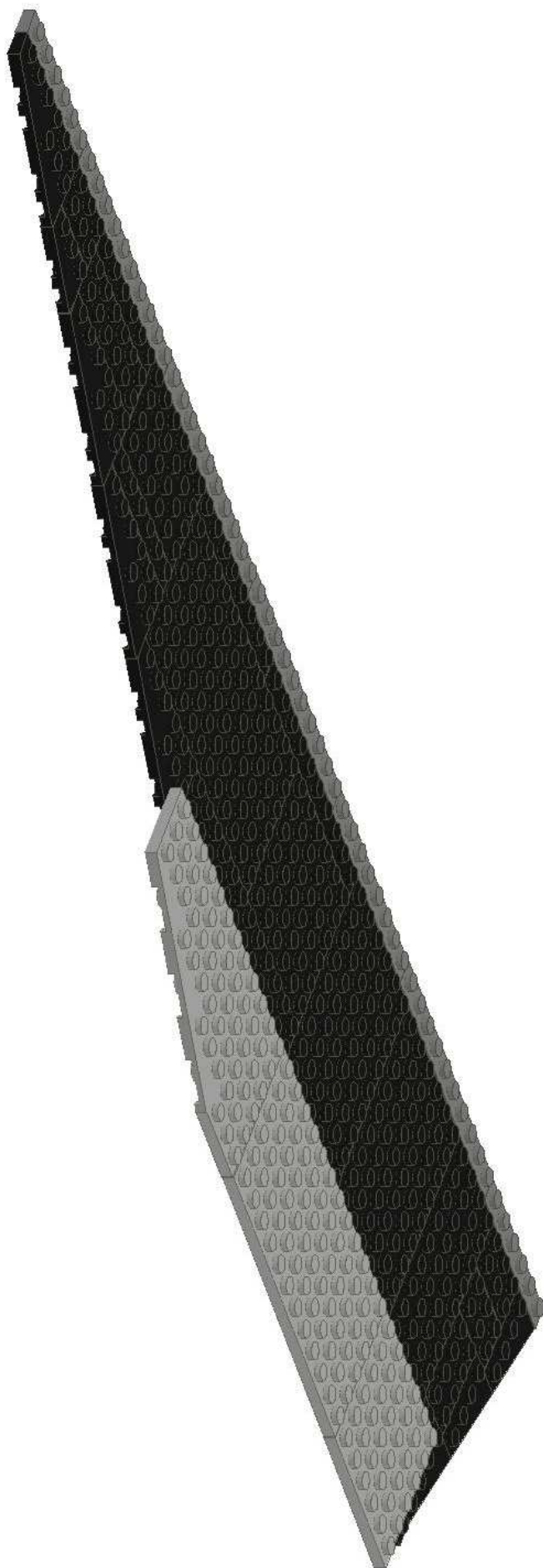

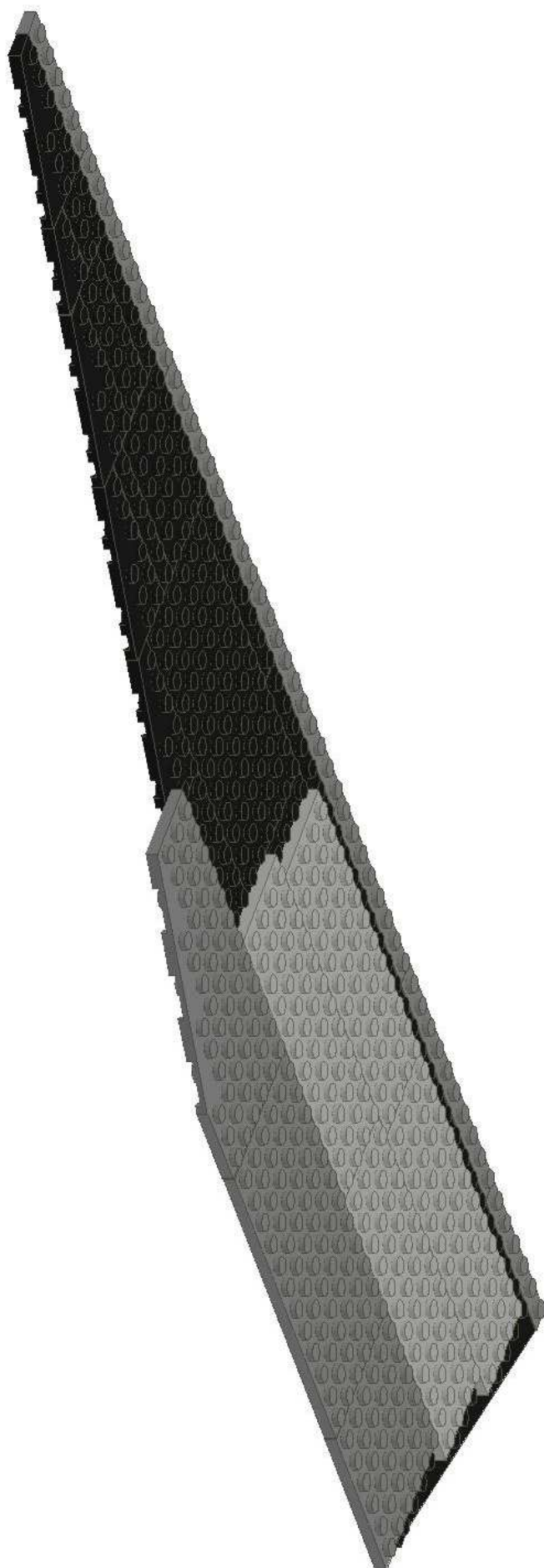

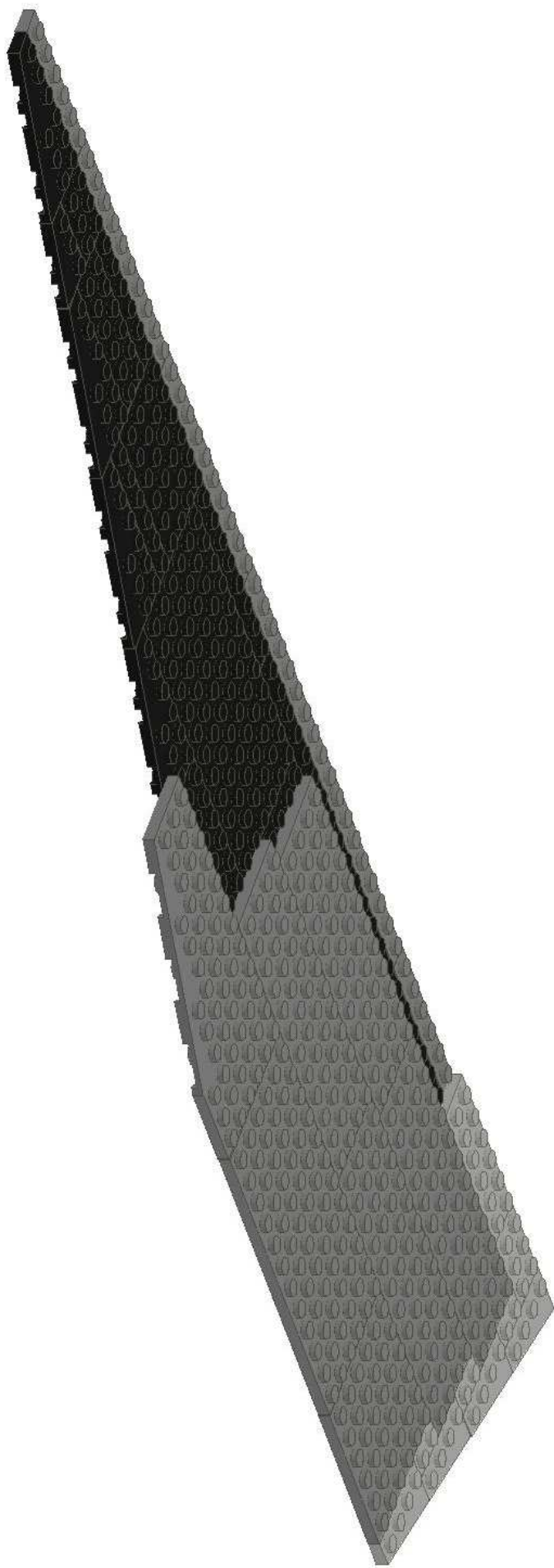

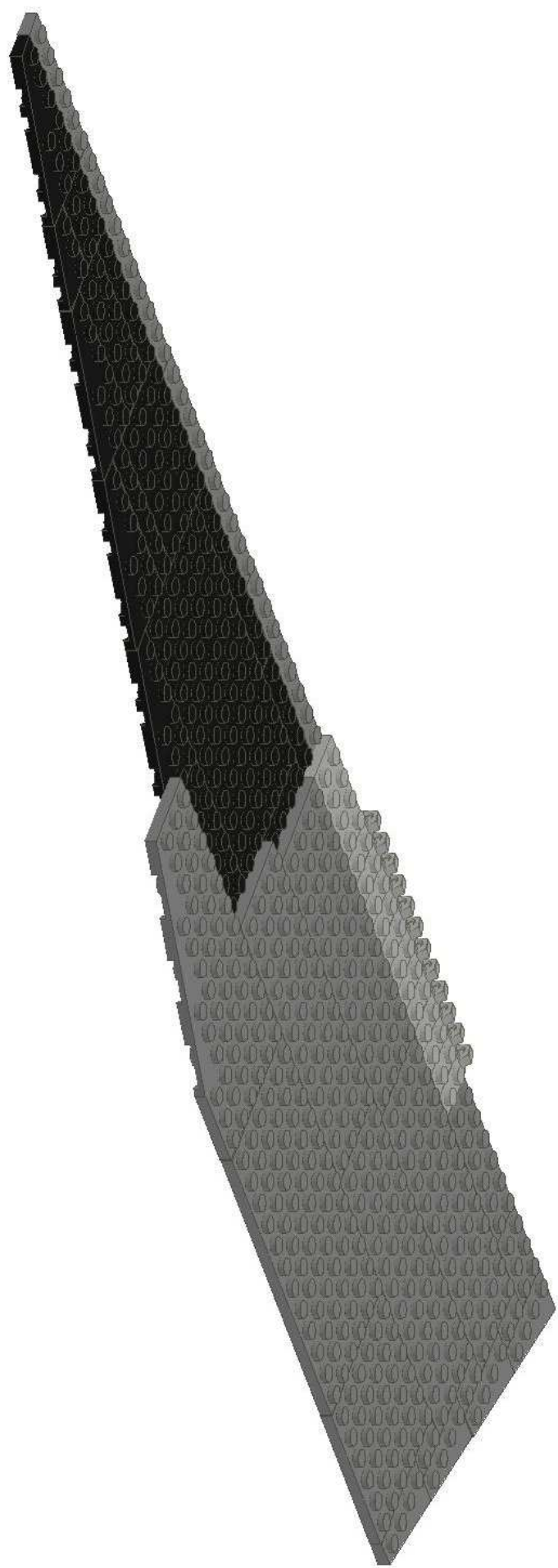

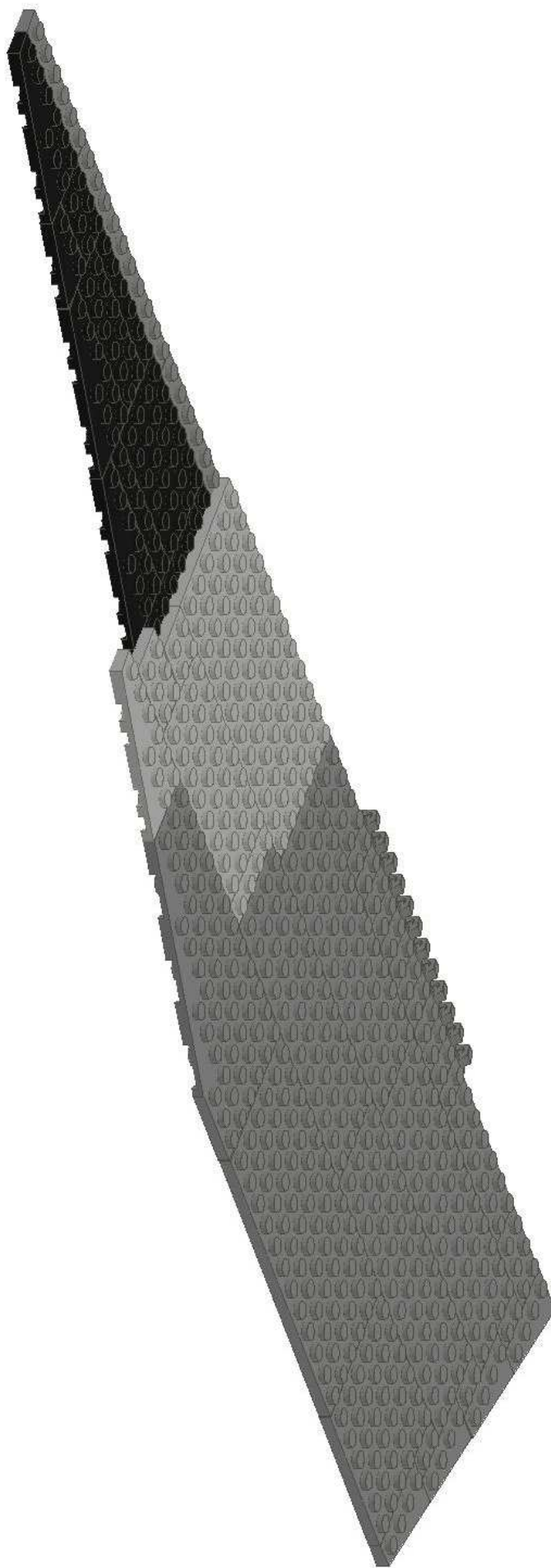

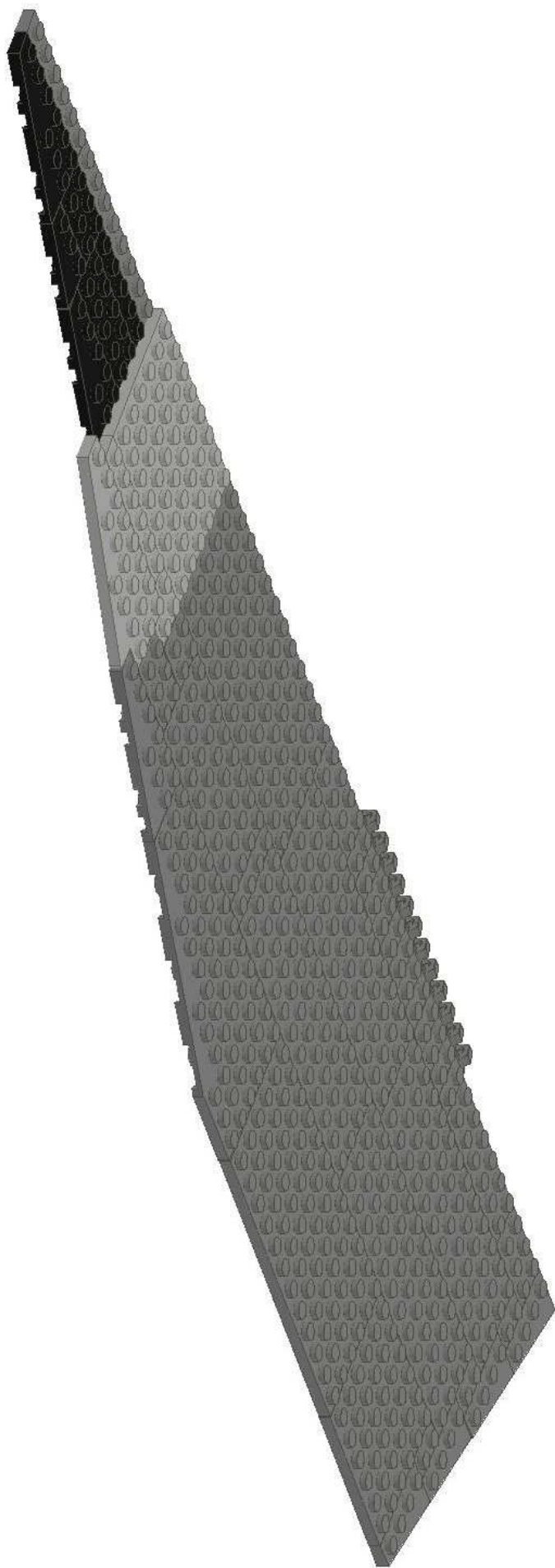

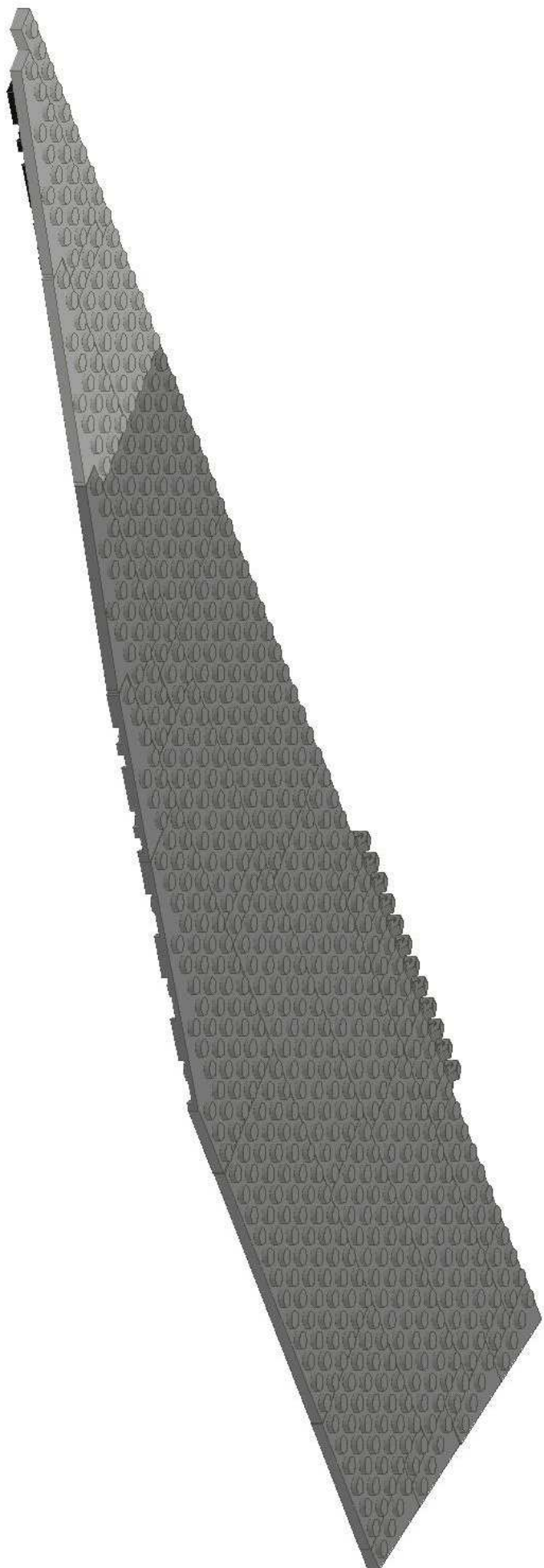

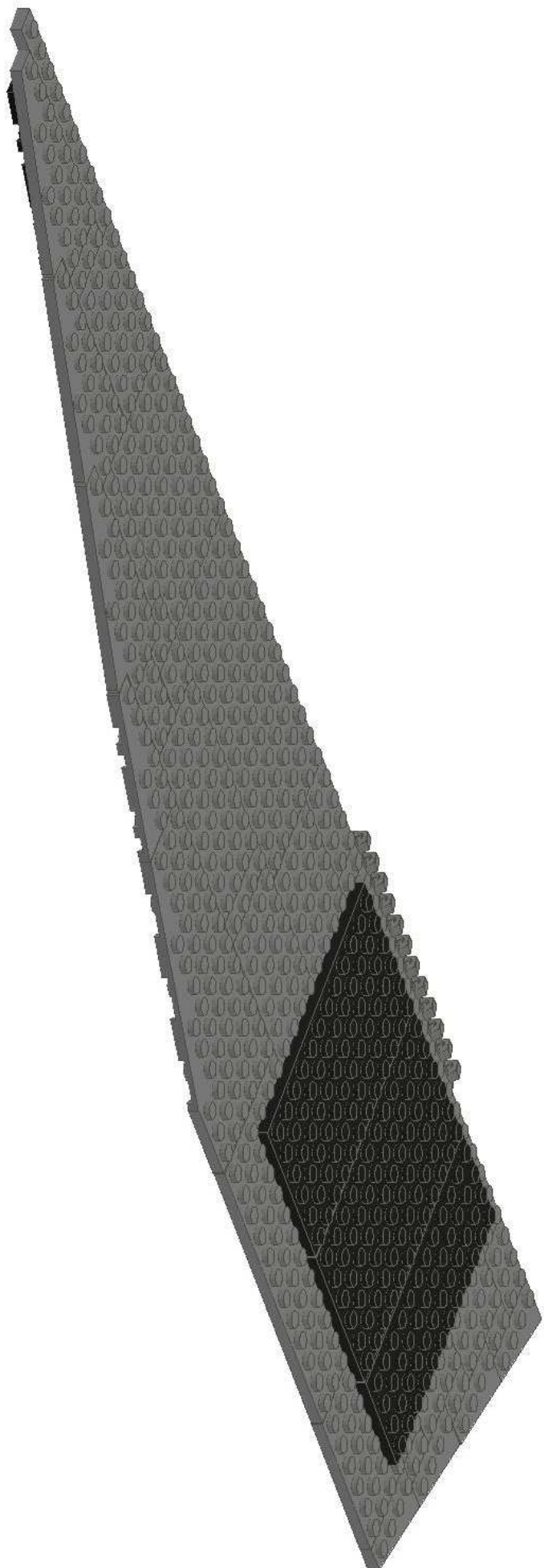

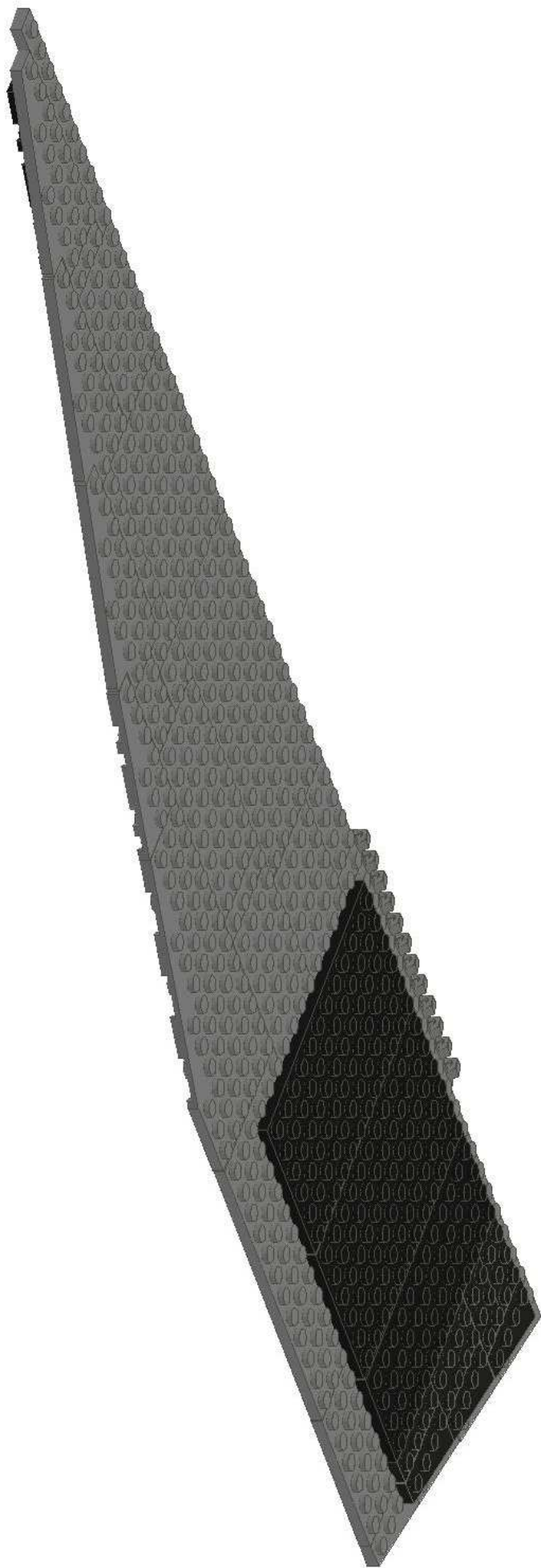

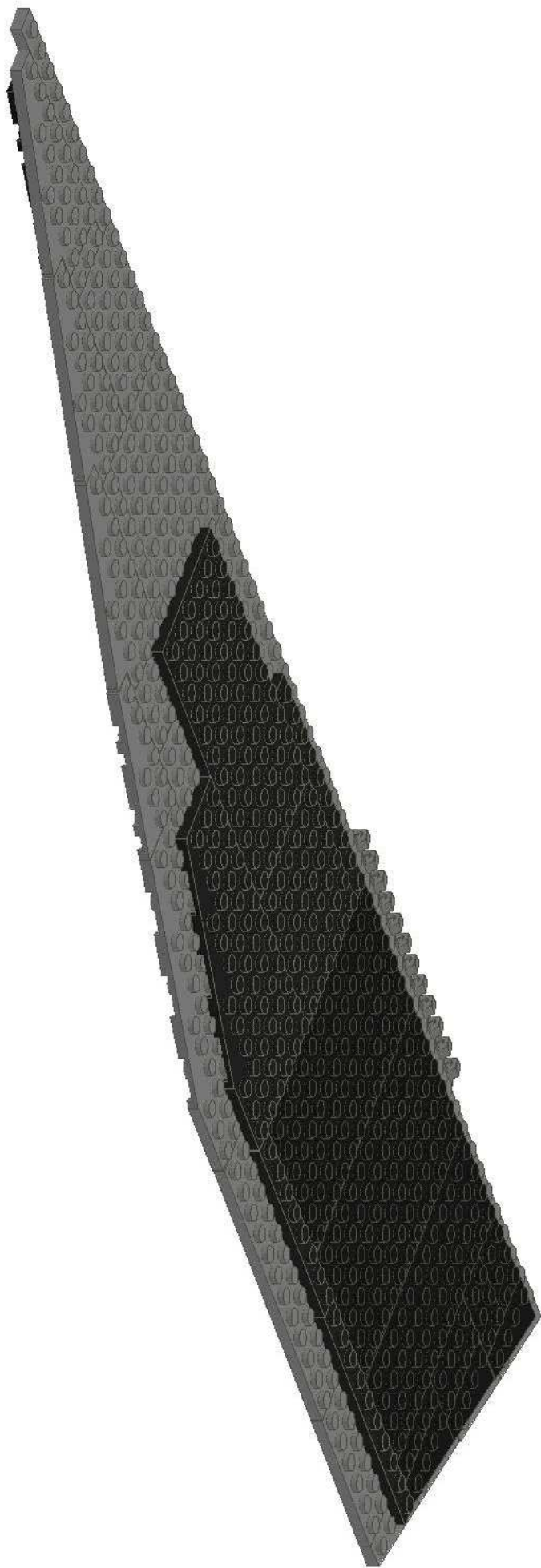

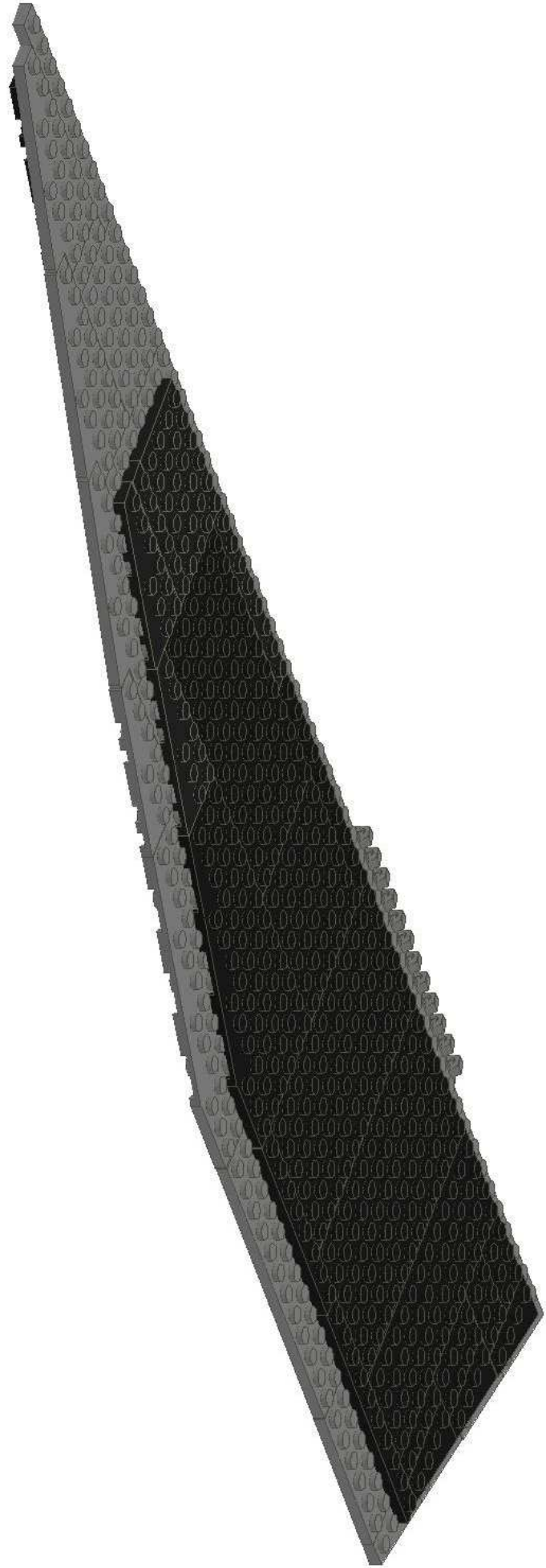

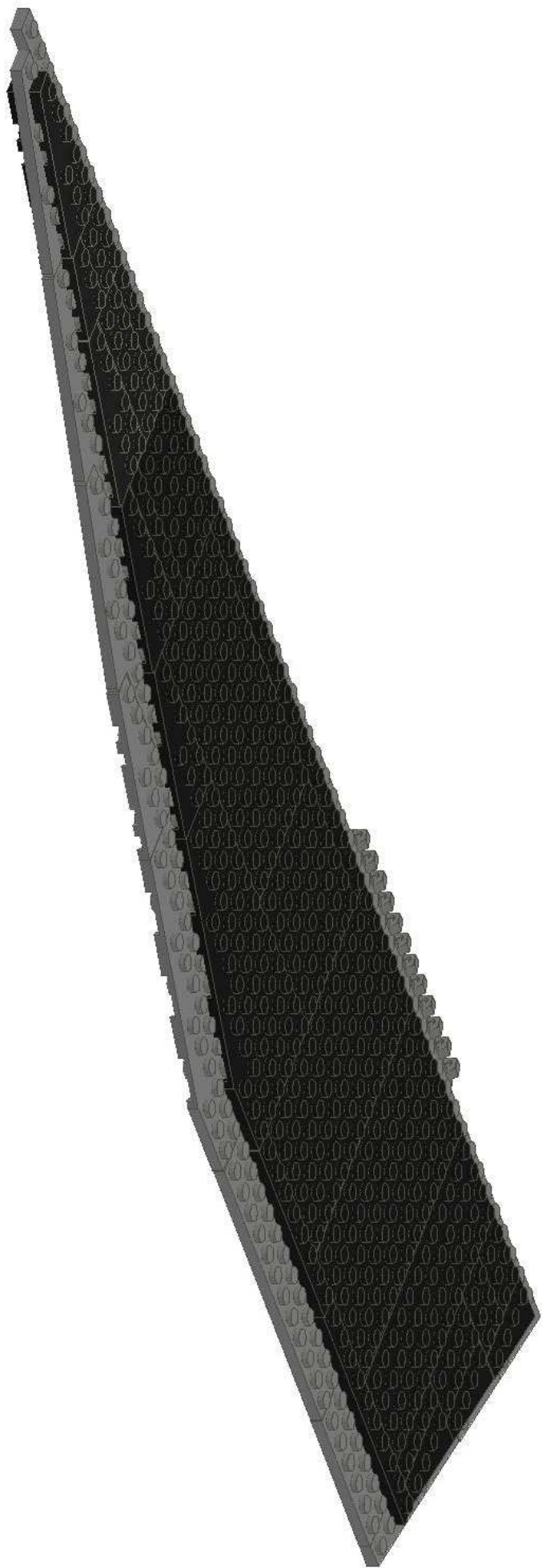

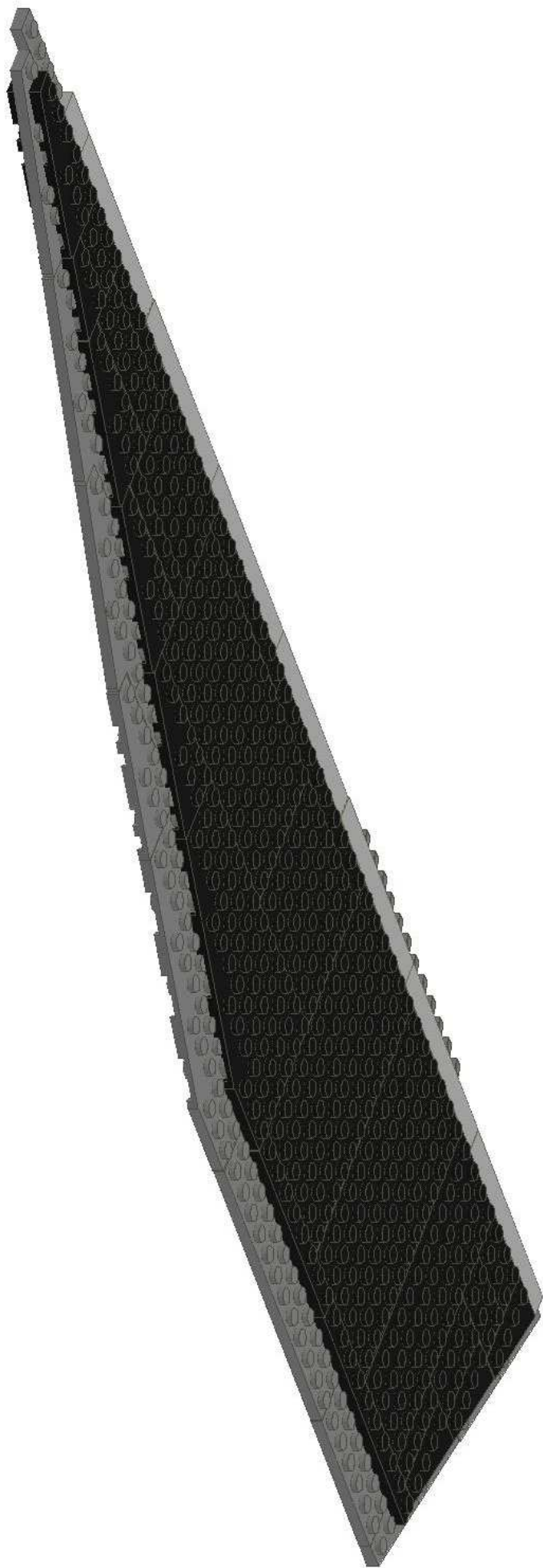

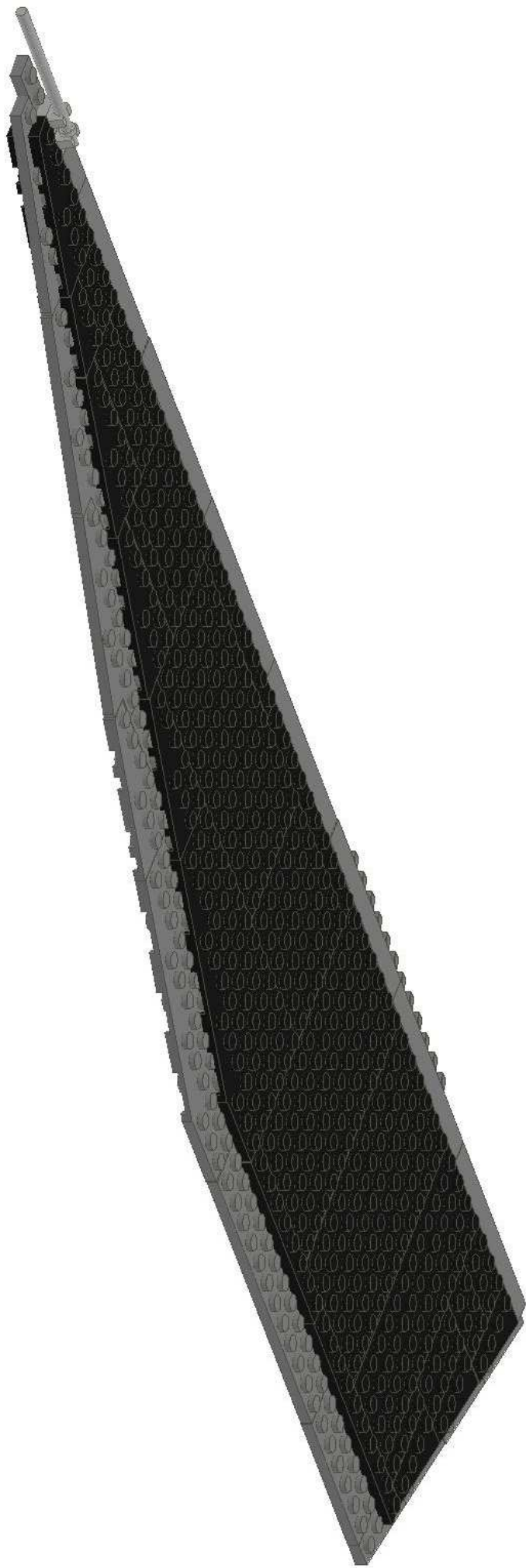

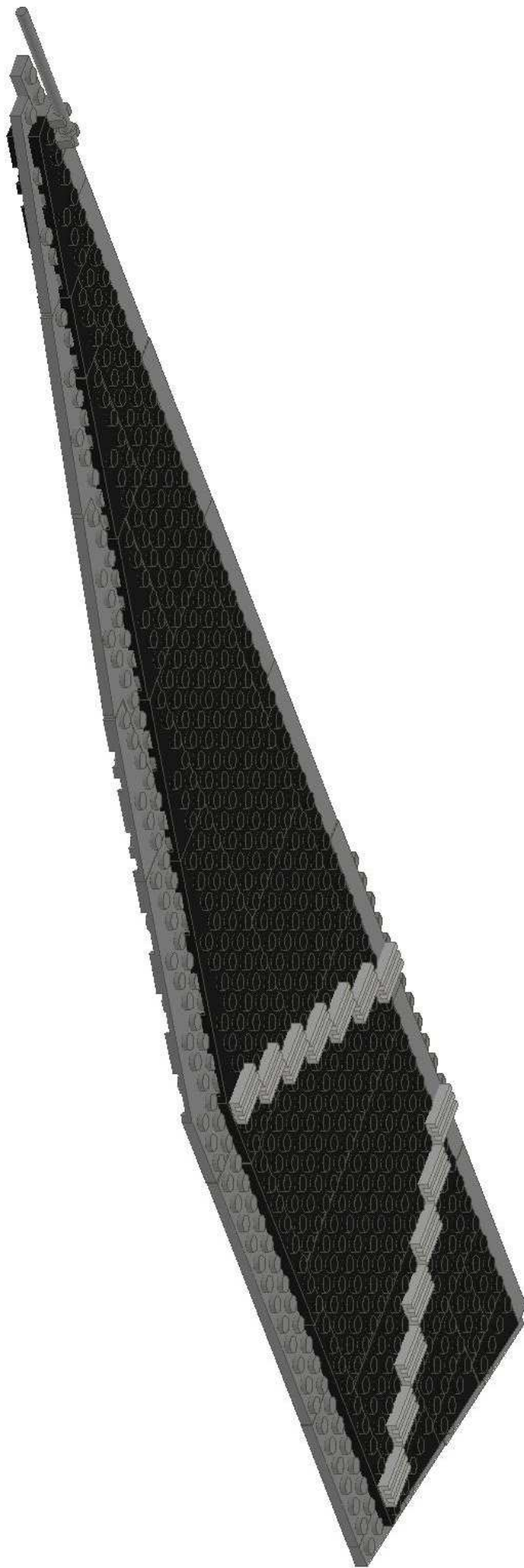





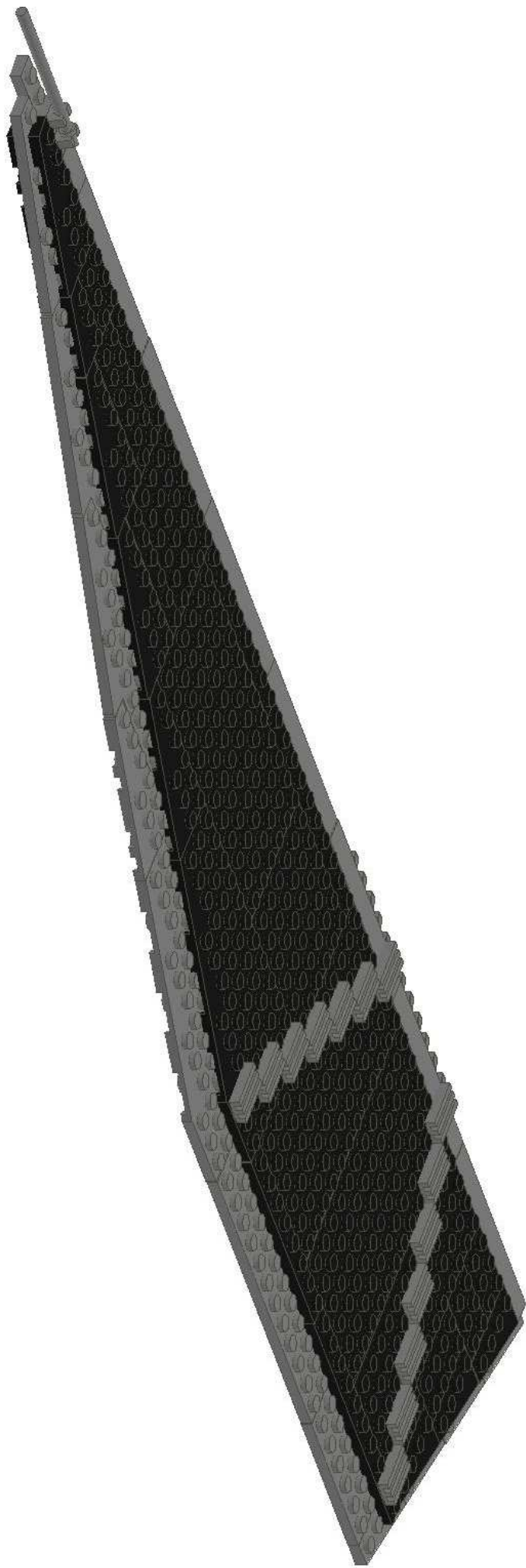

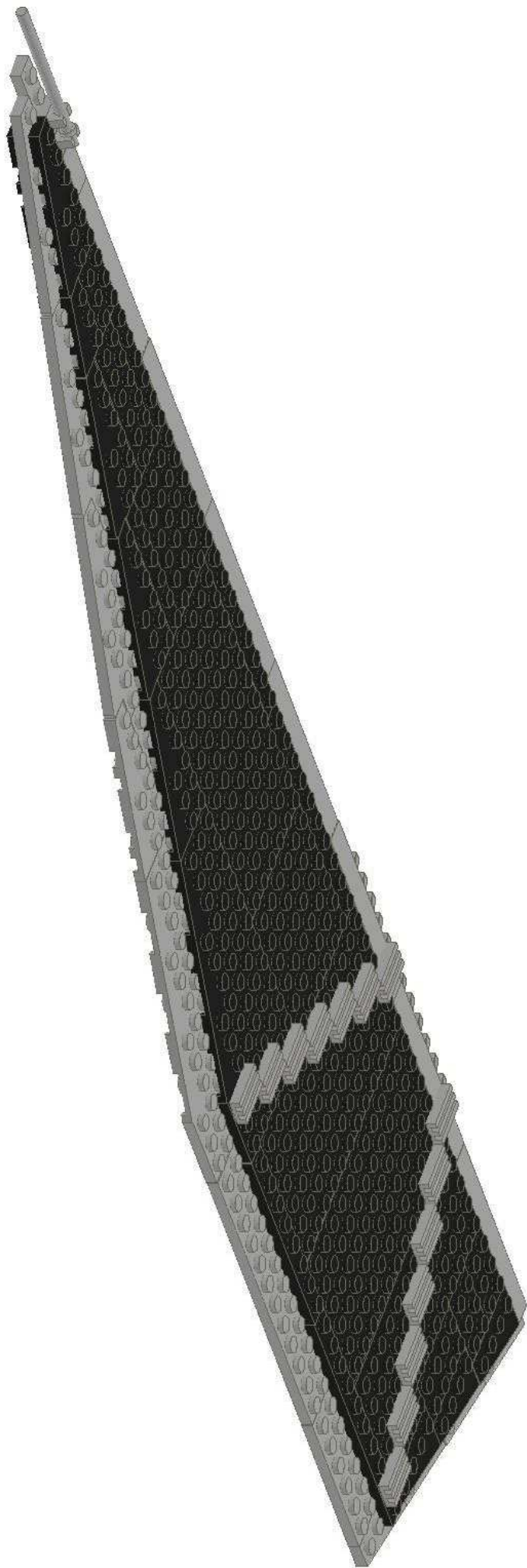

x3

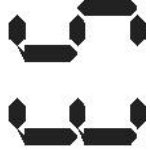





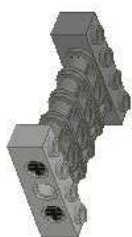







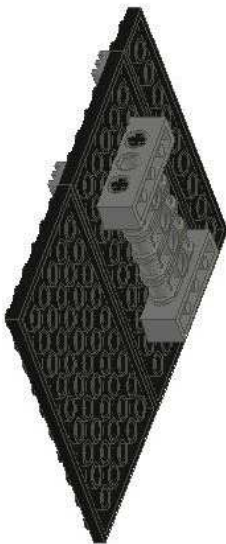

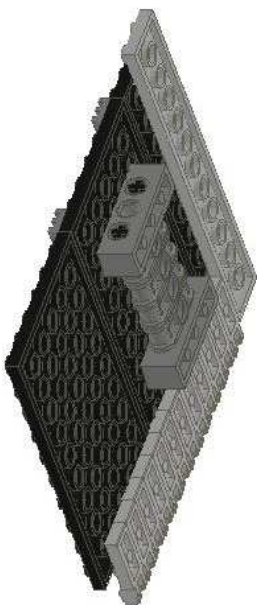

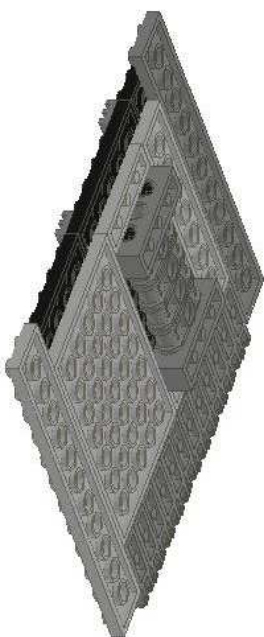





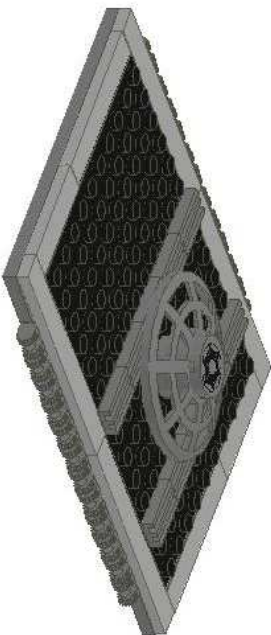

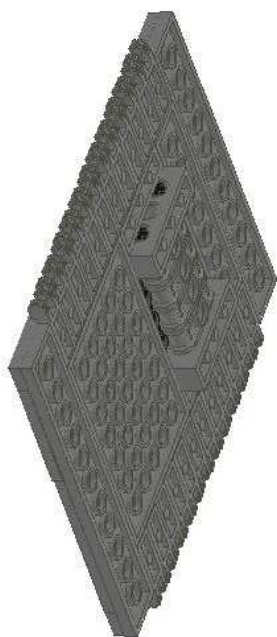

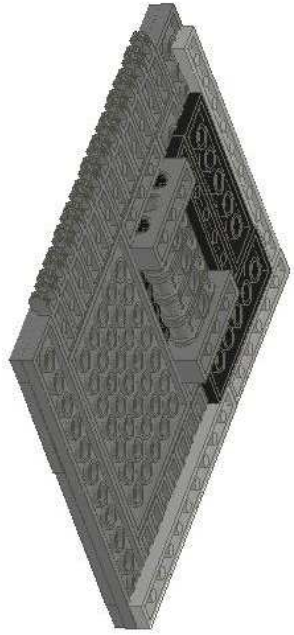

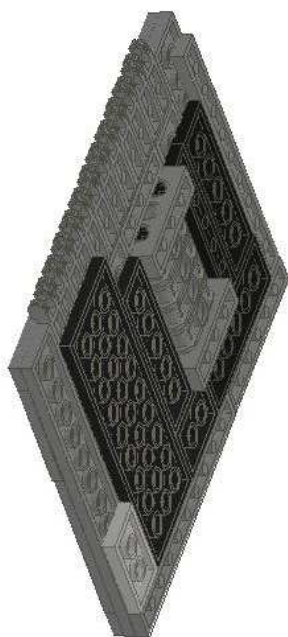

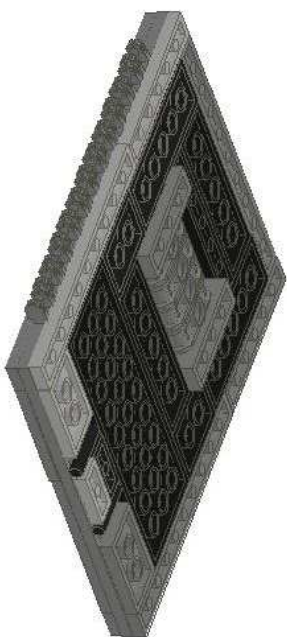

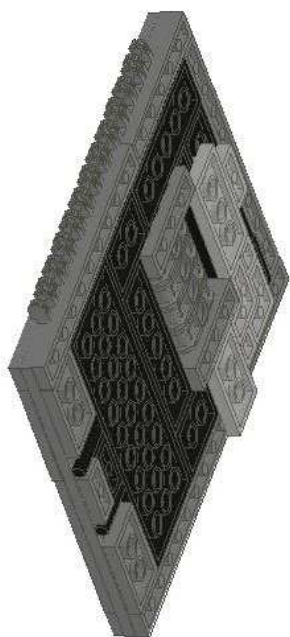

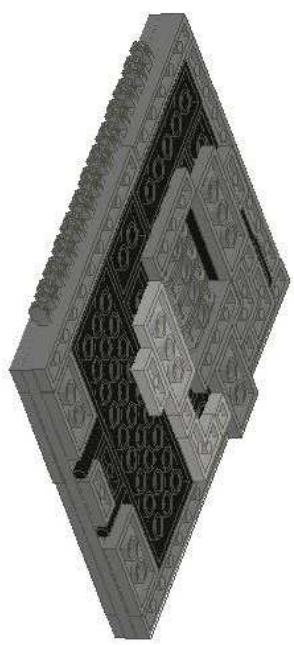

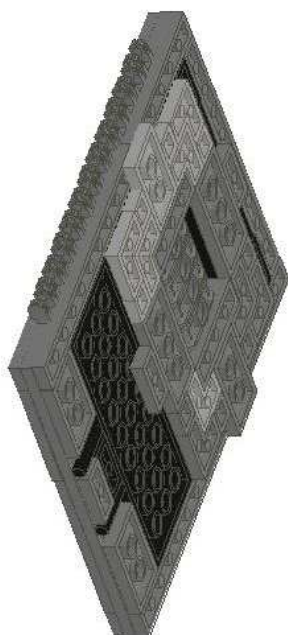

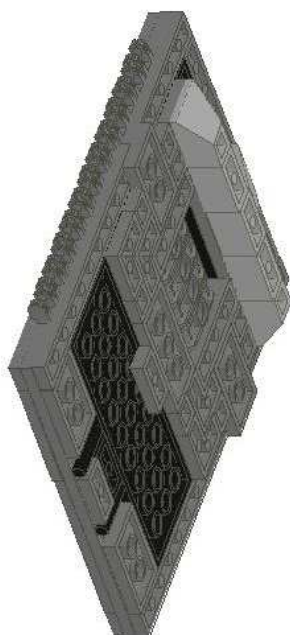

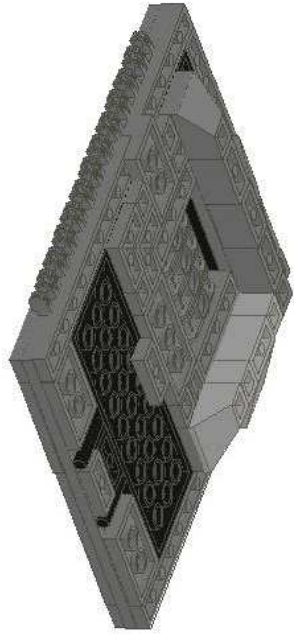

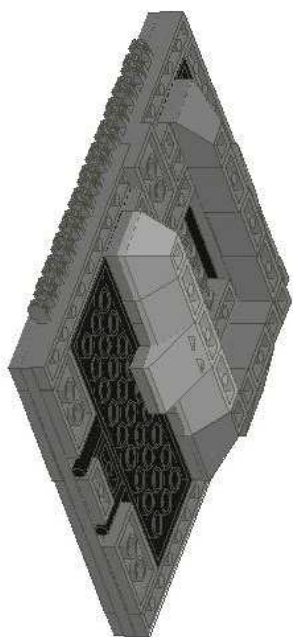

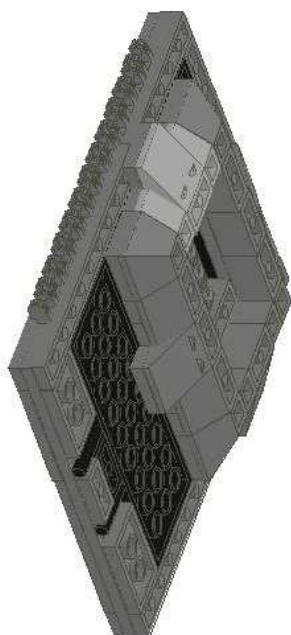

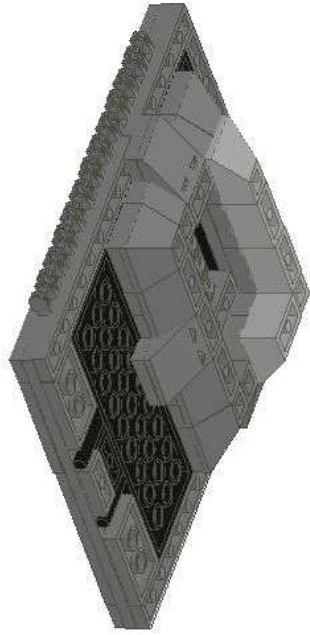

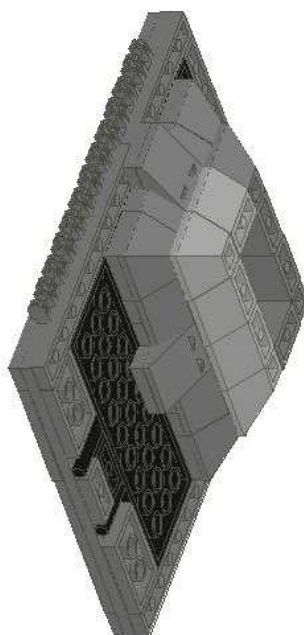

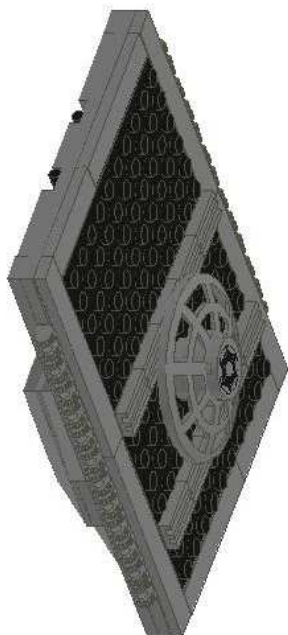

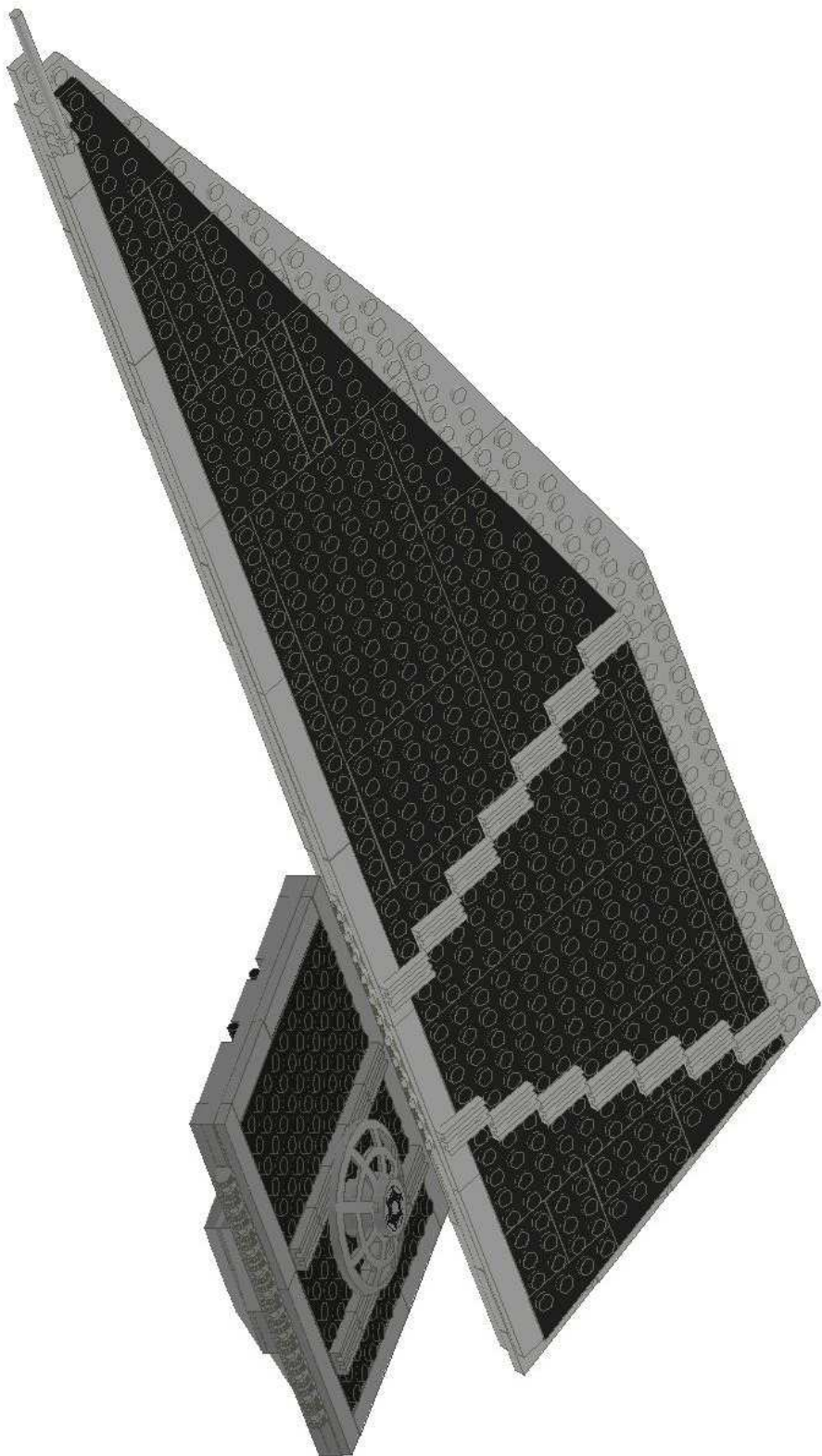



x3







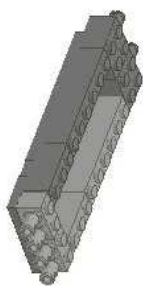







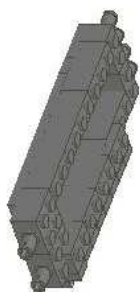





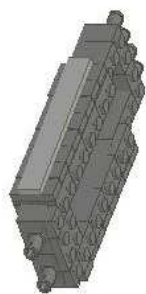



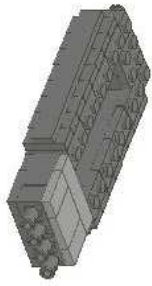

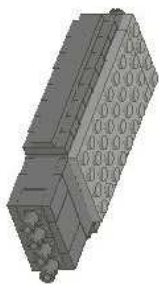

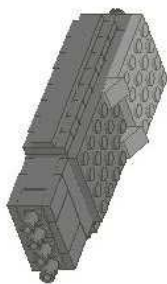

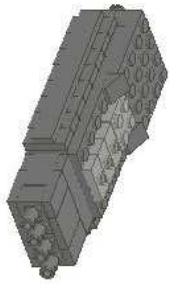

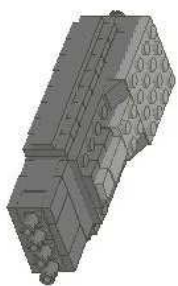

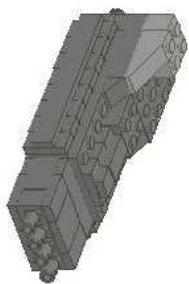

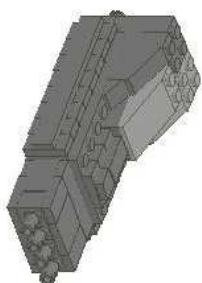

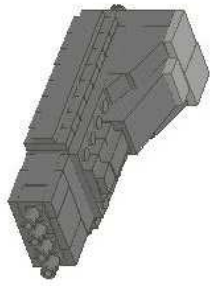

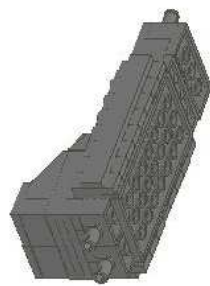

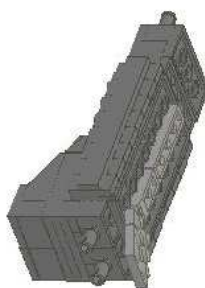

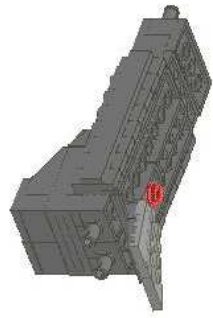





x3

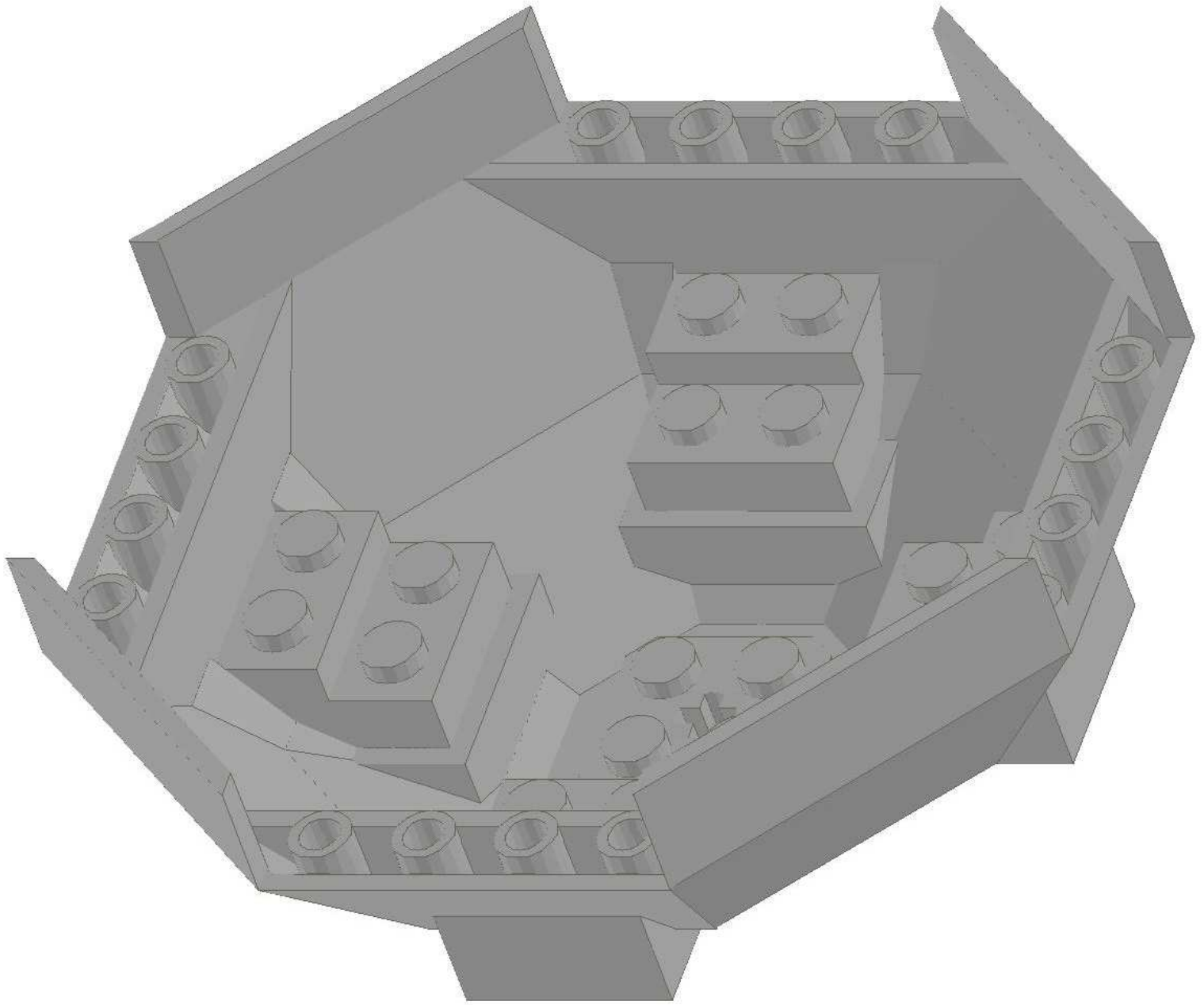

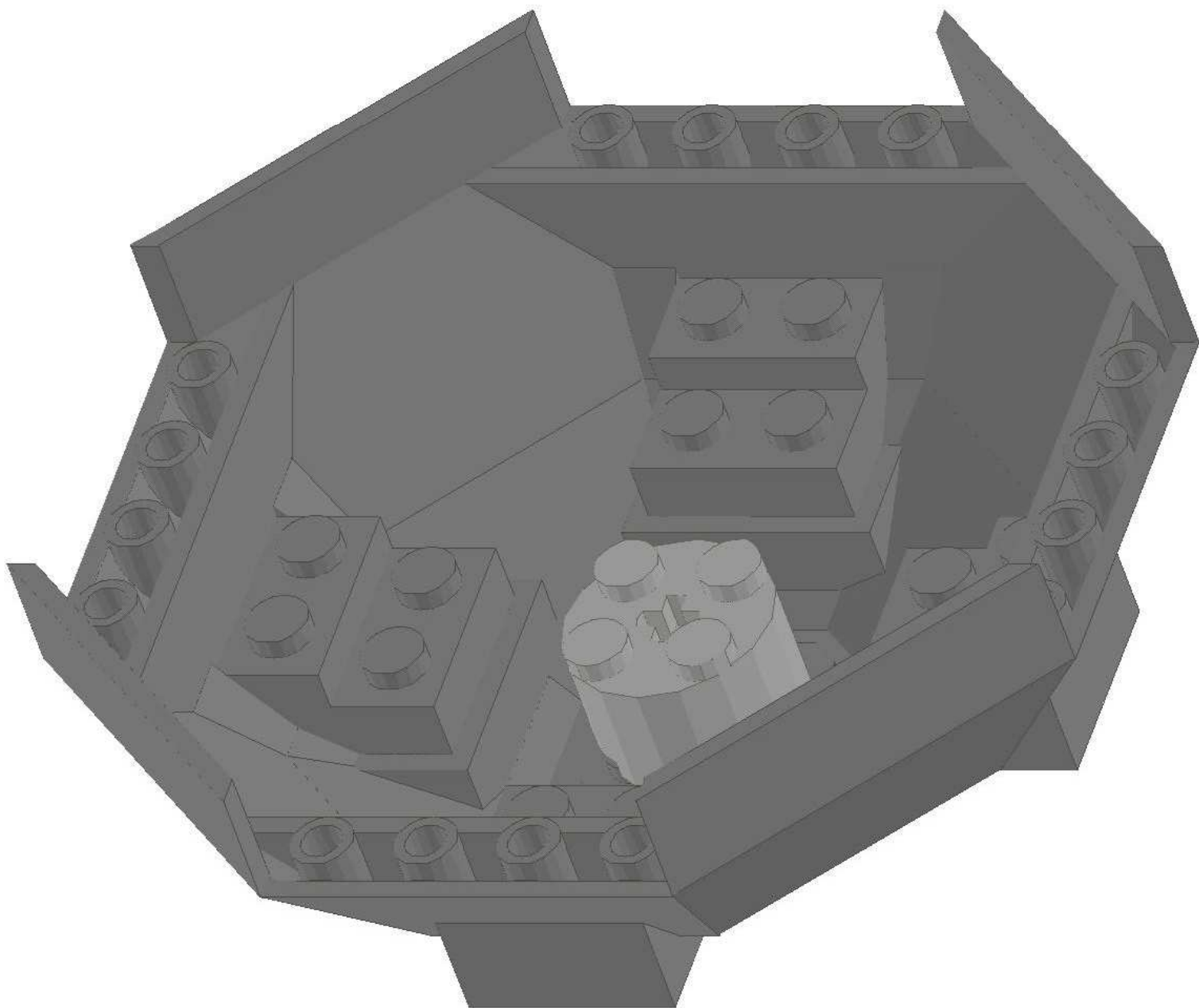

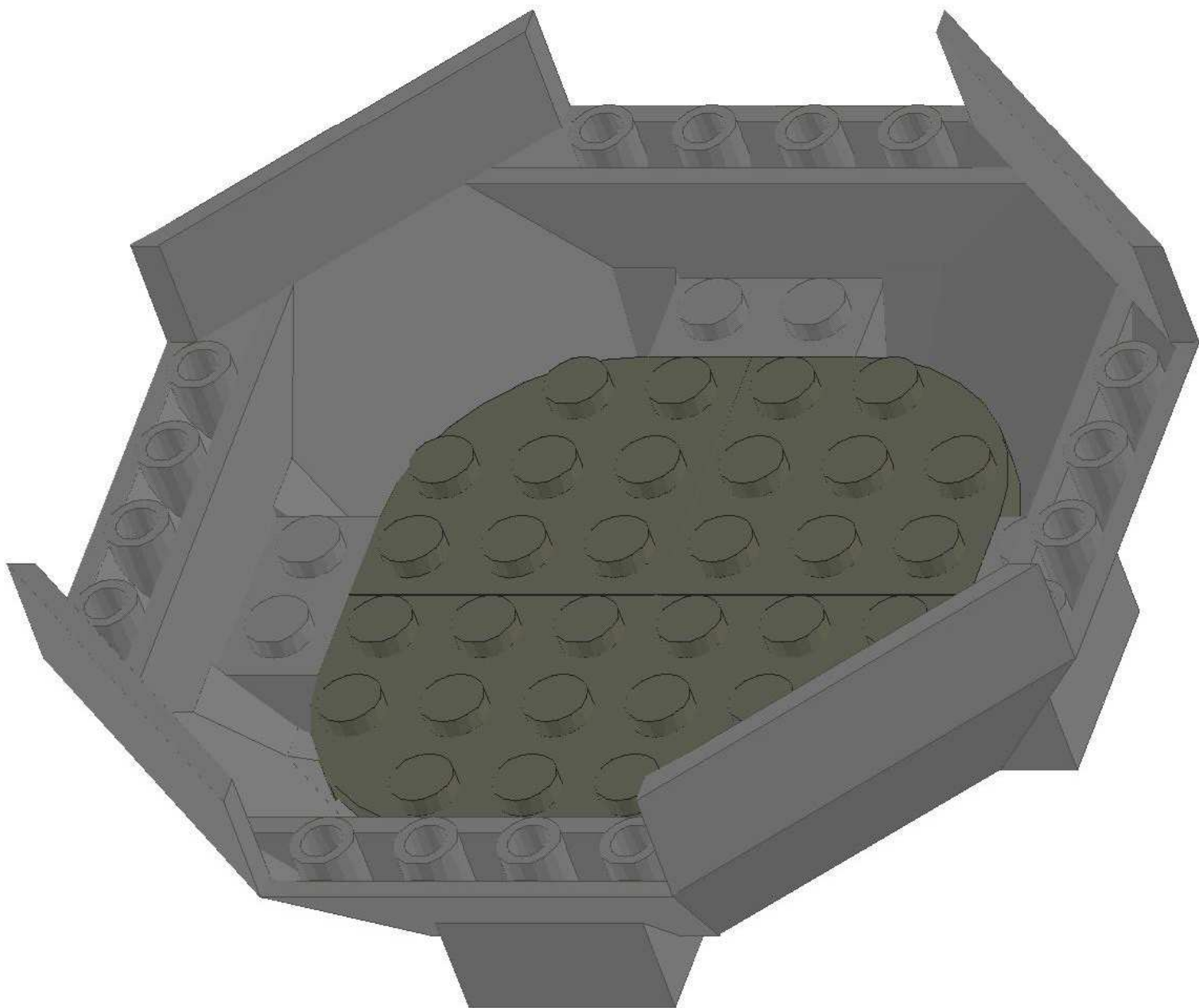

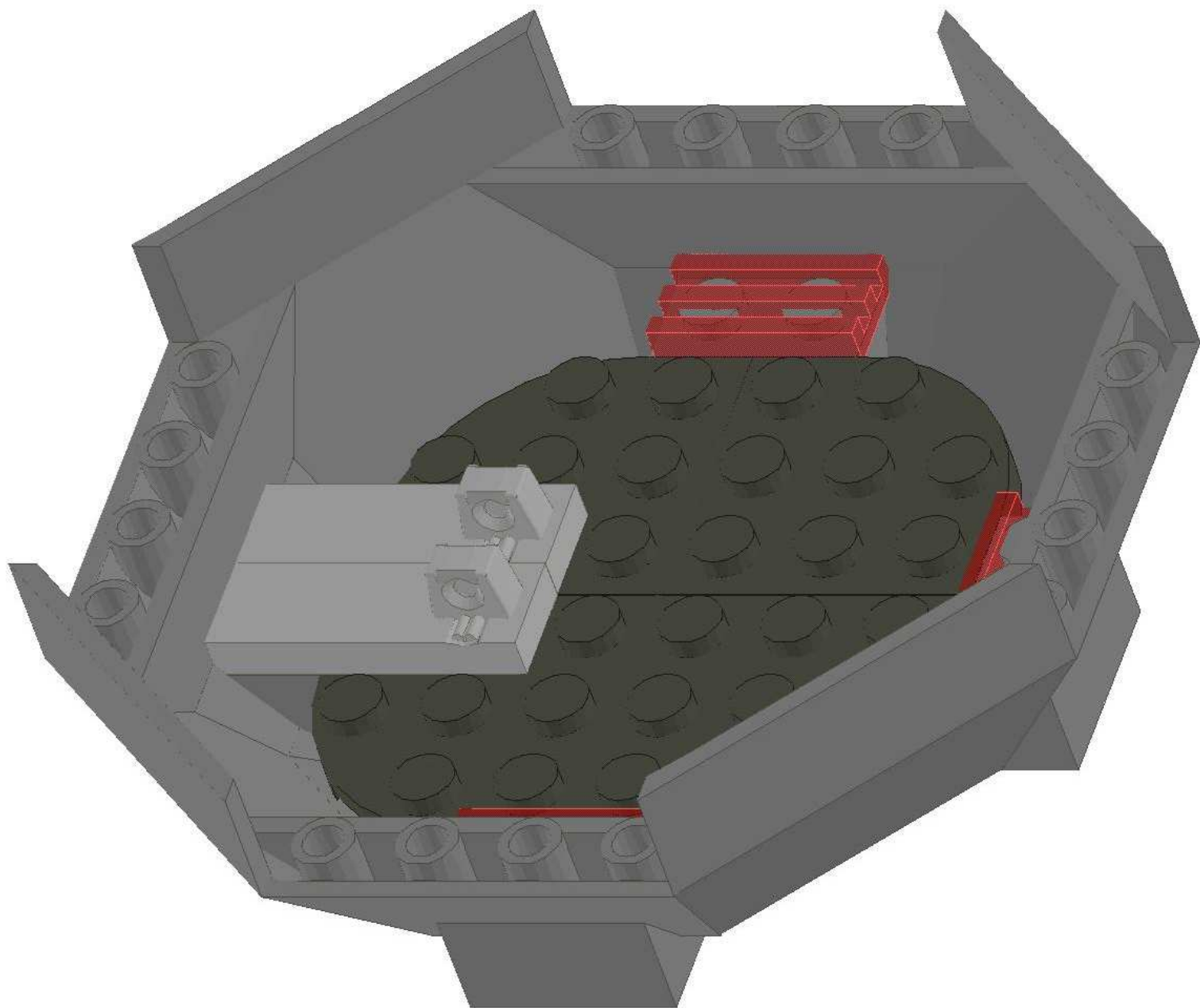

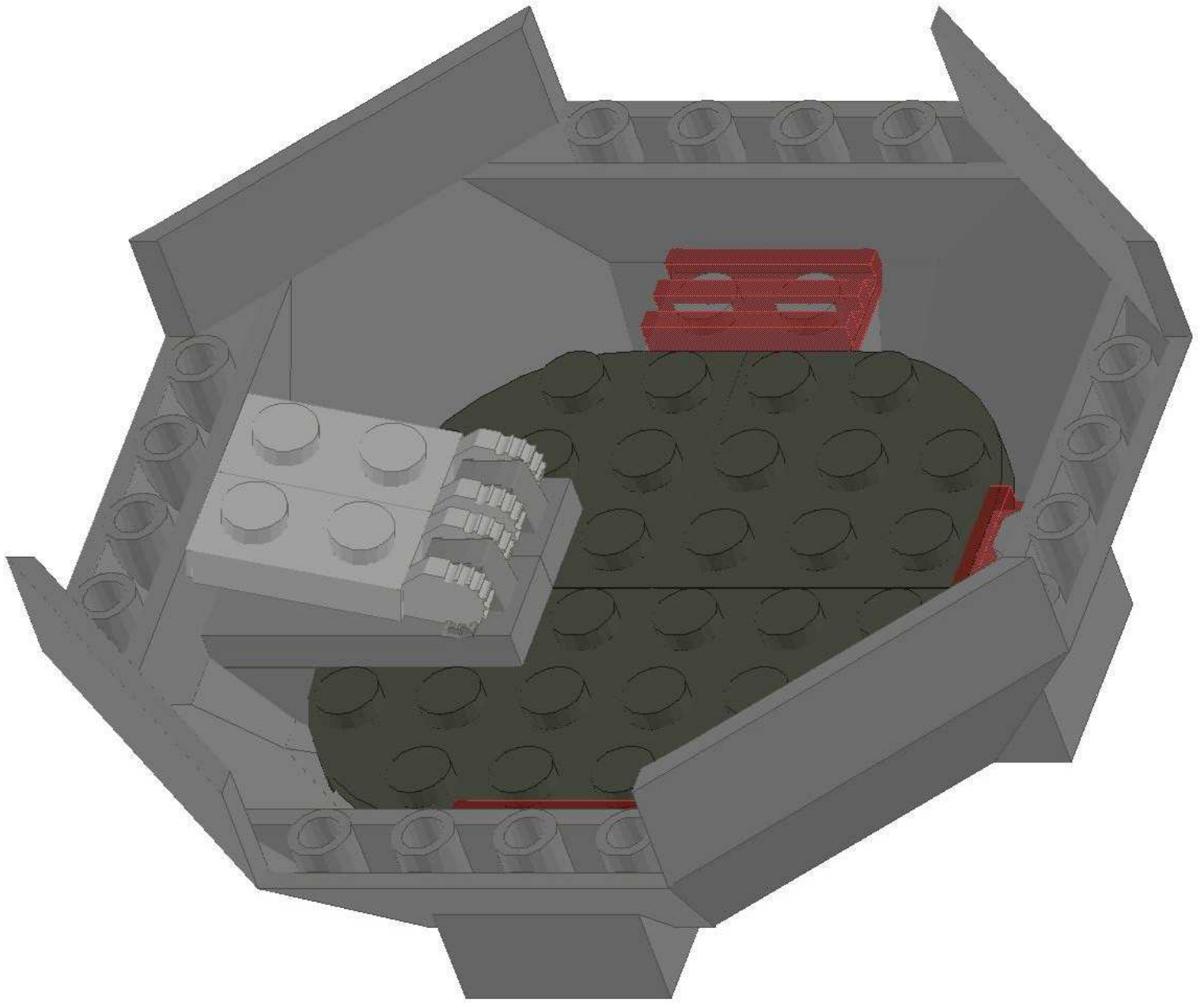

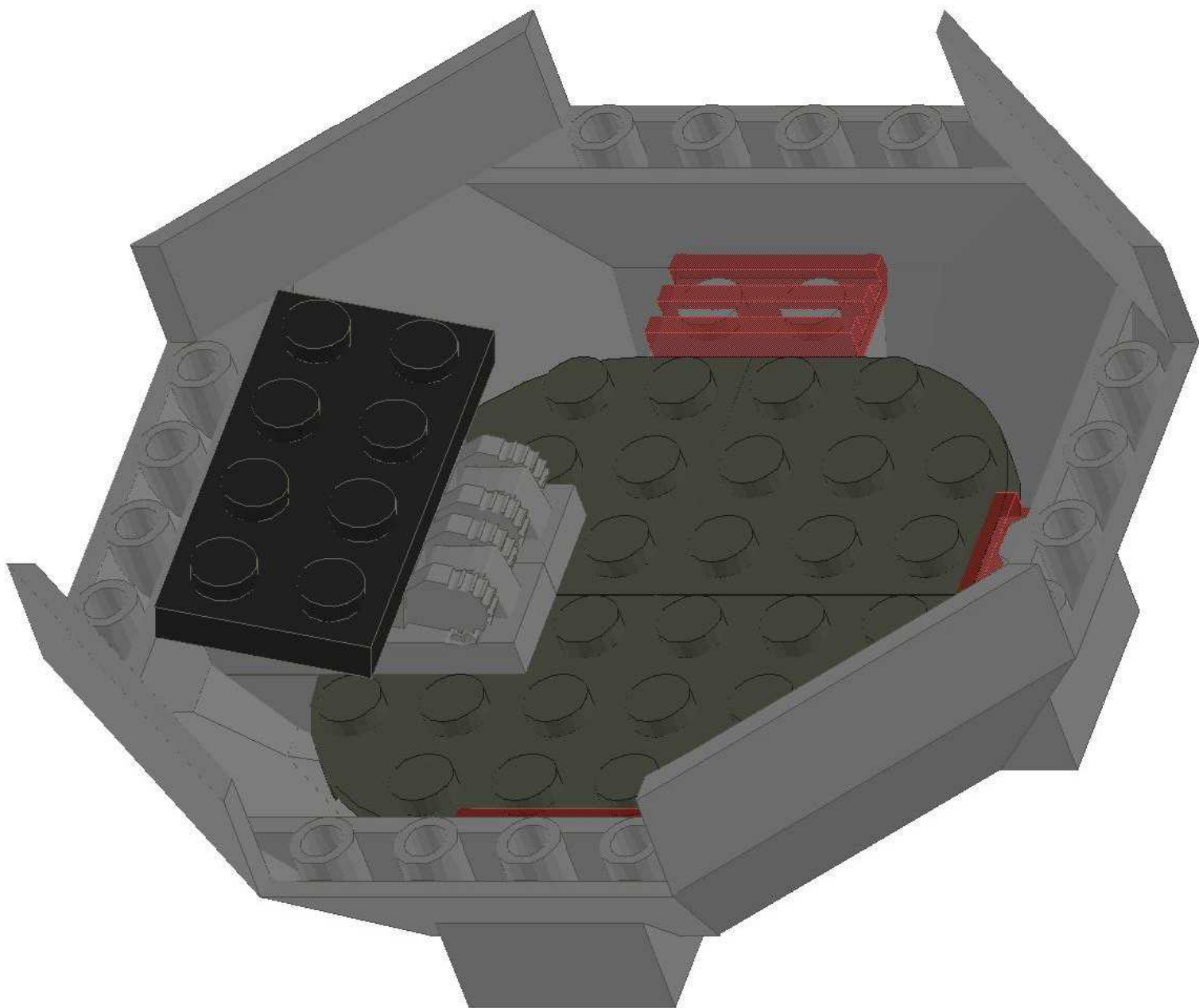

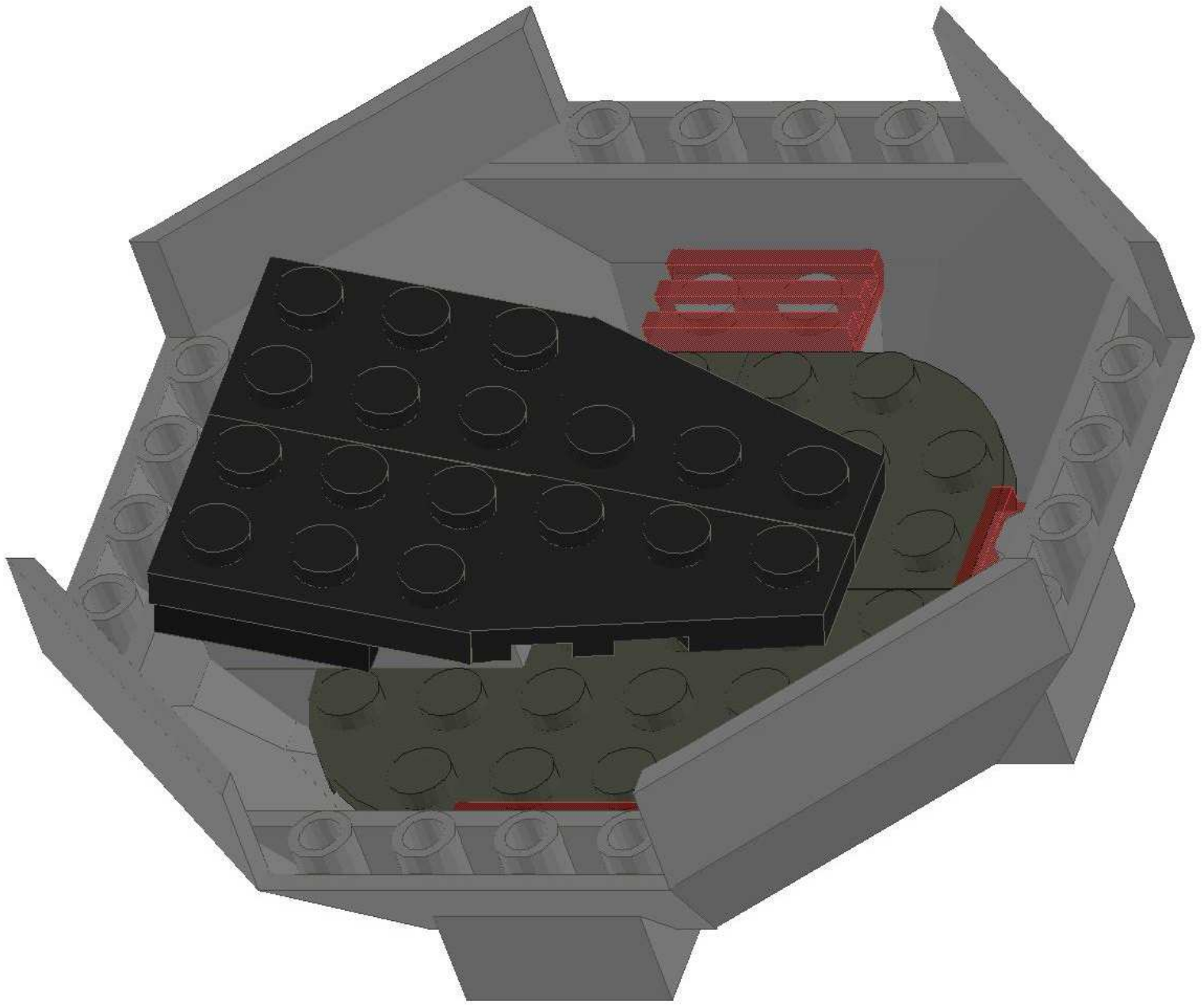

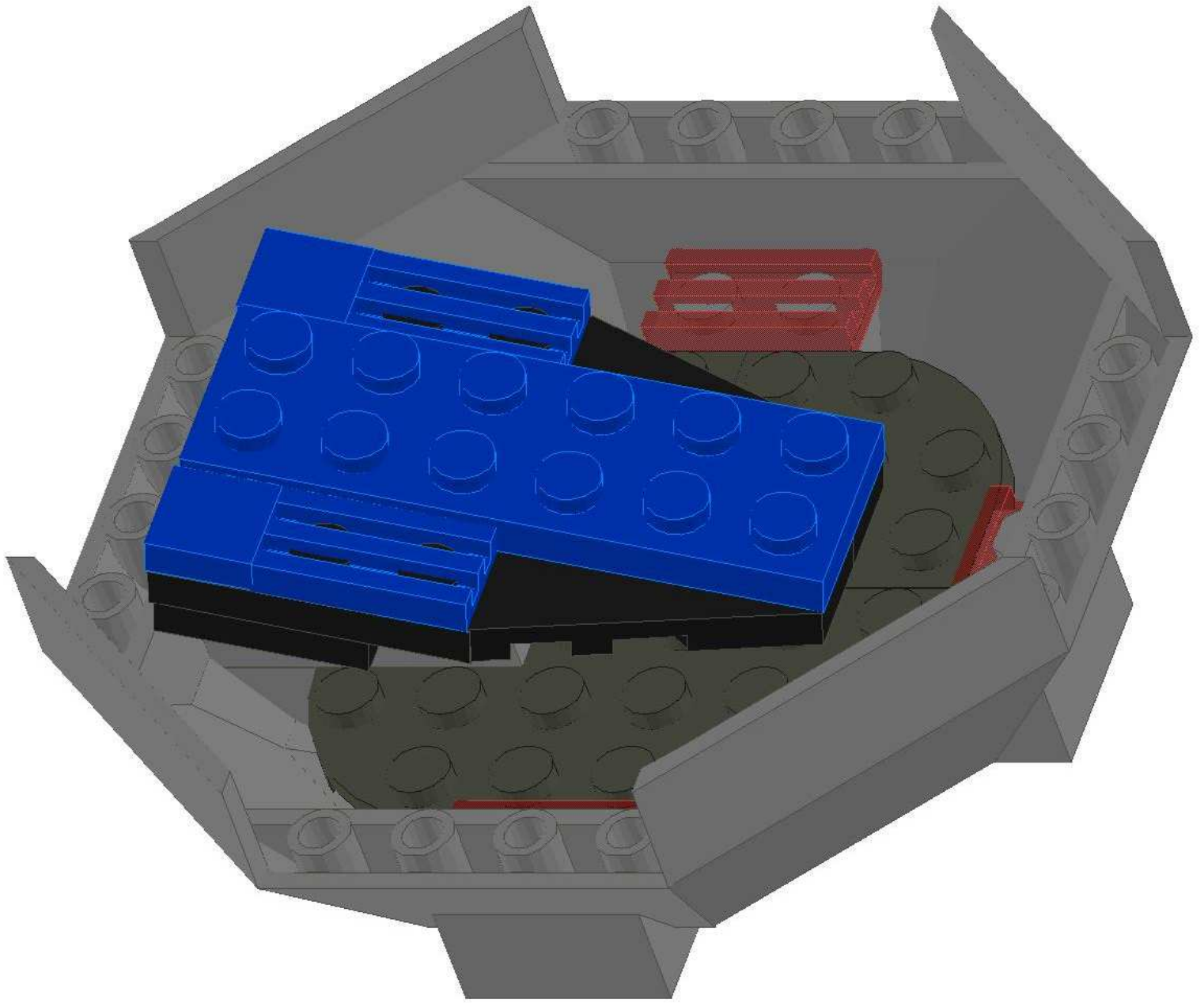





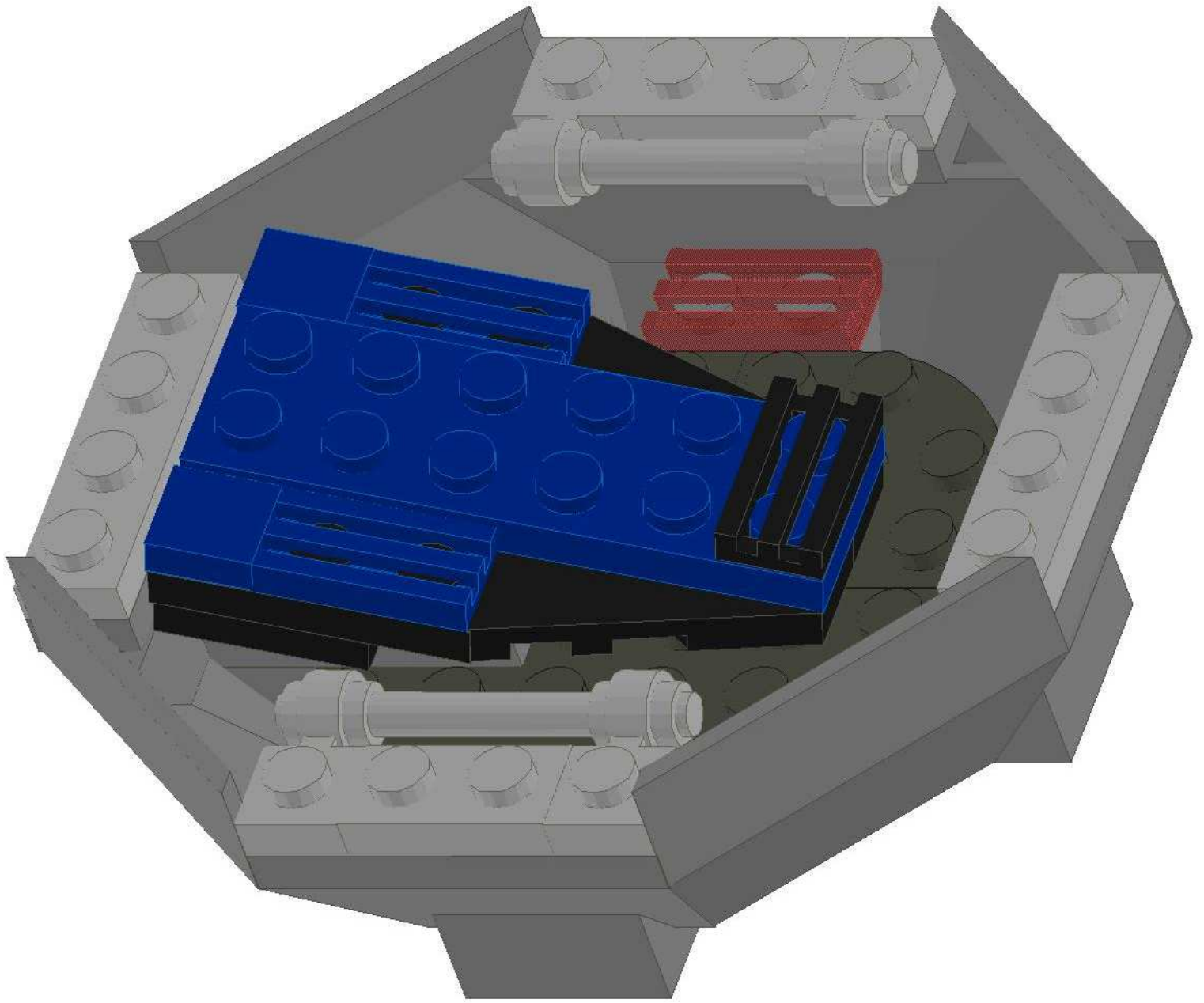

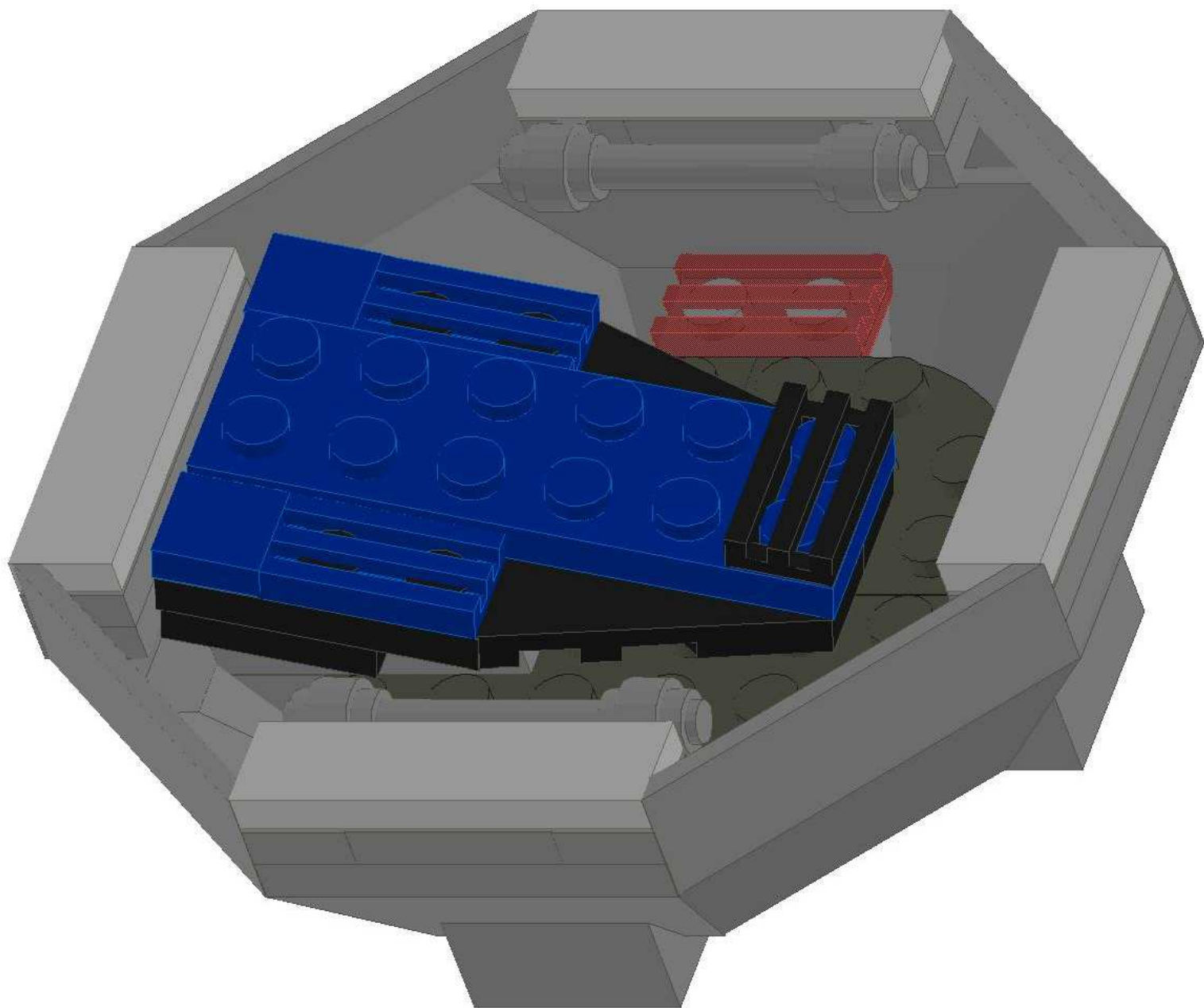

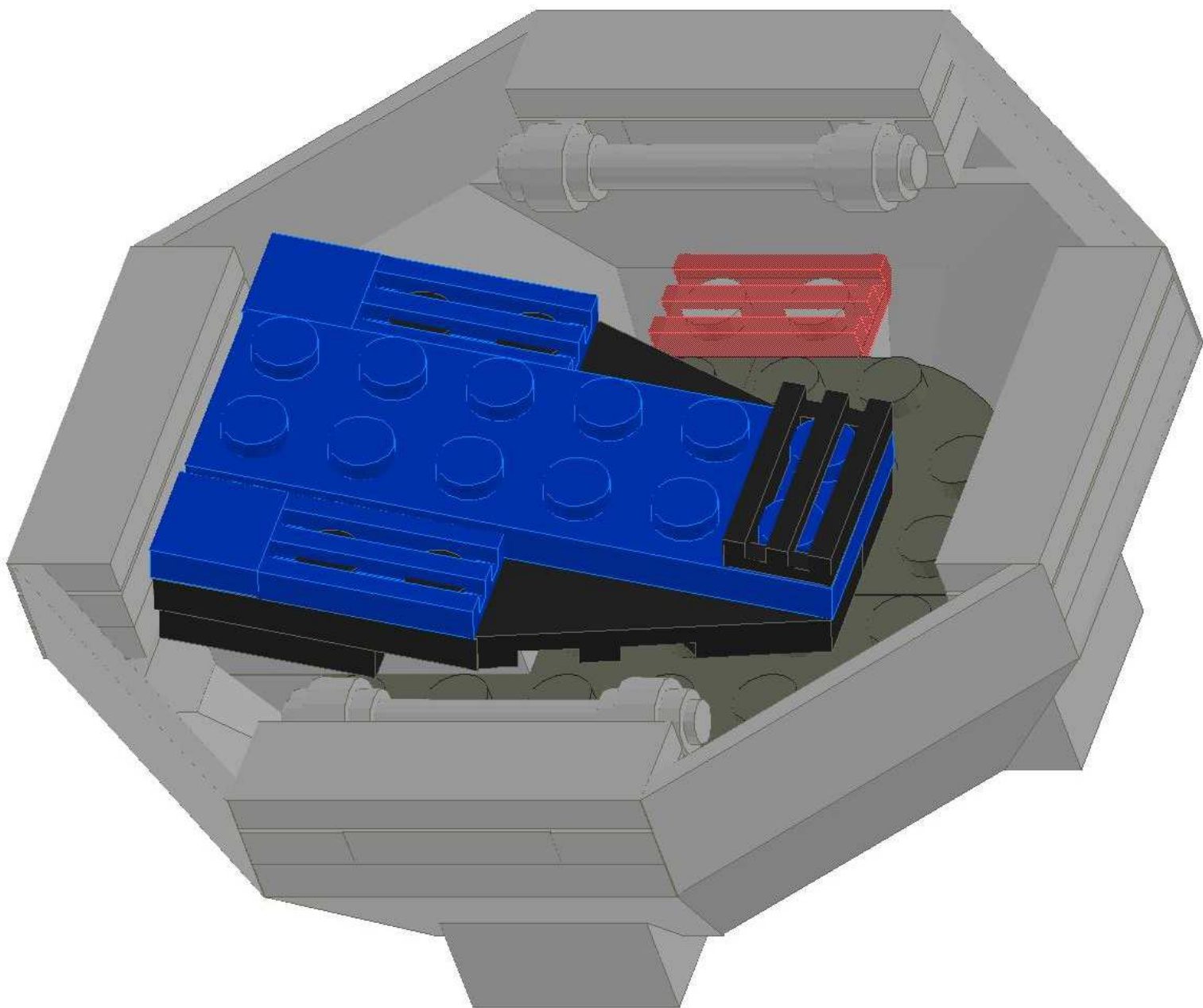

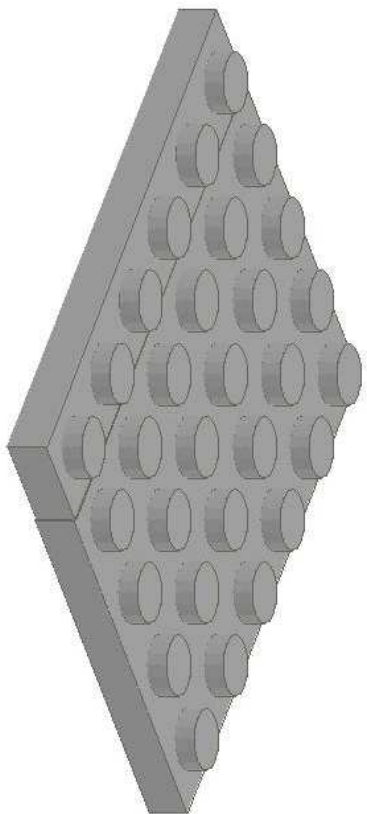

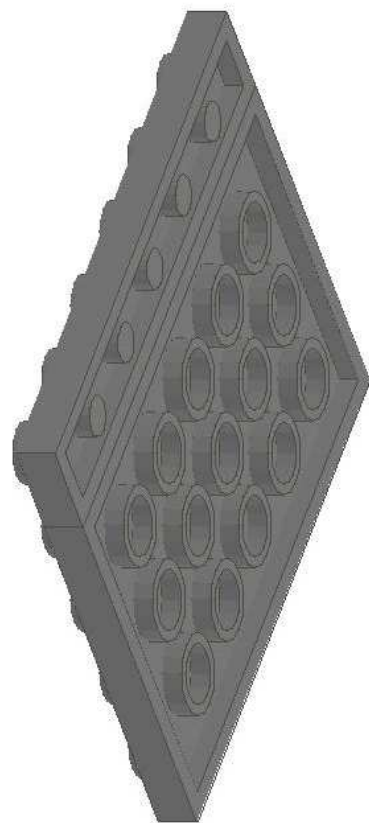

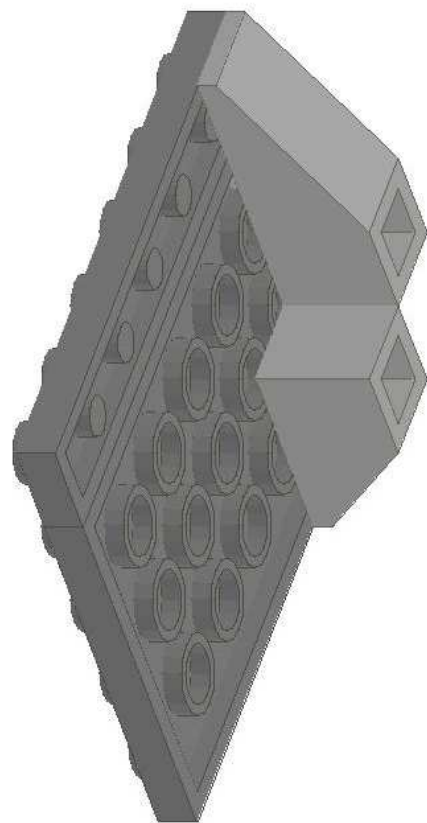

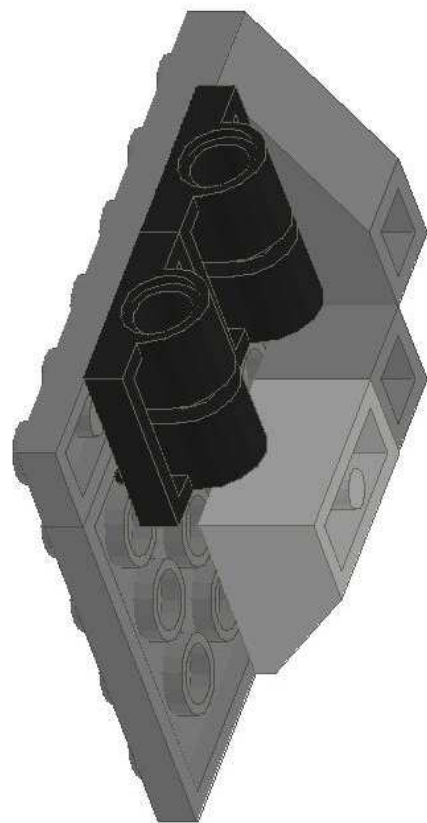

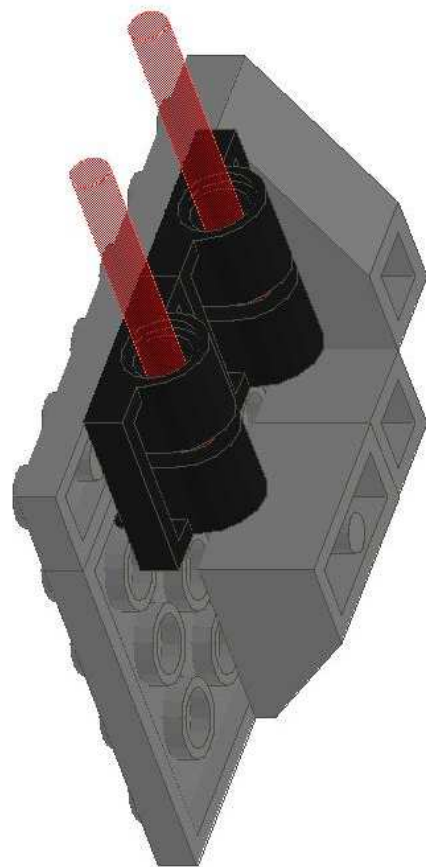

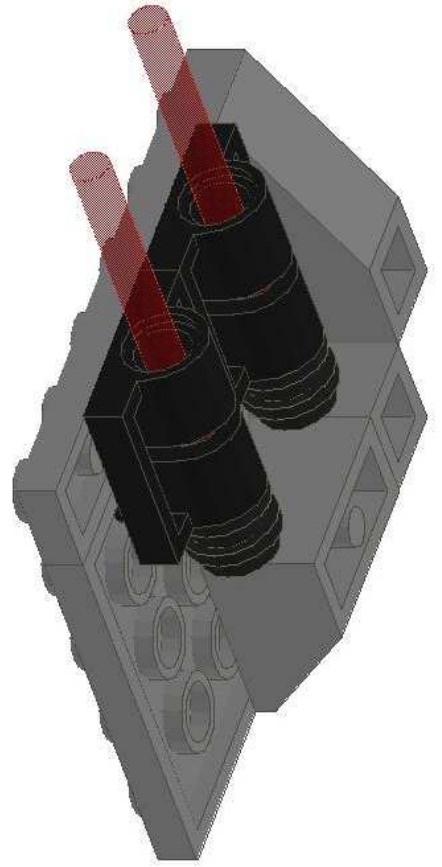

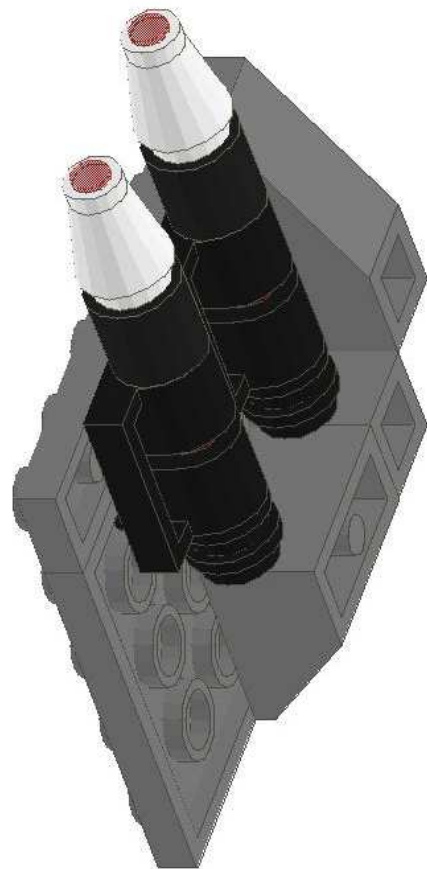

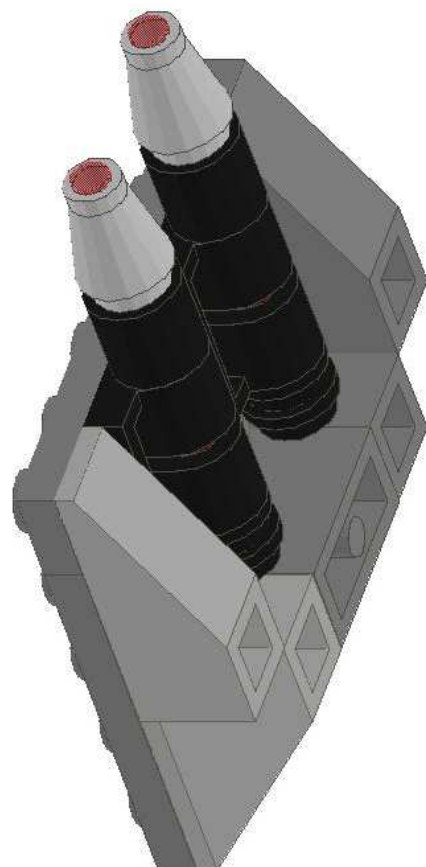

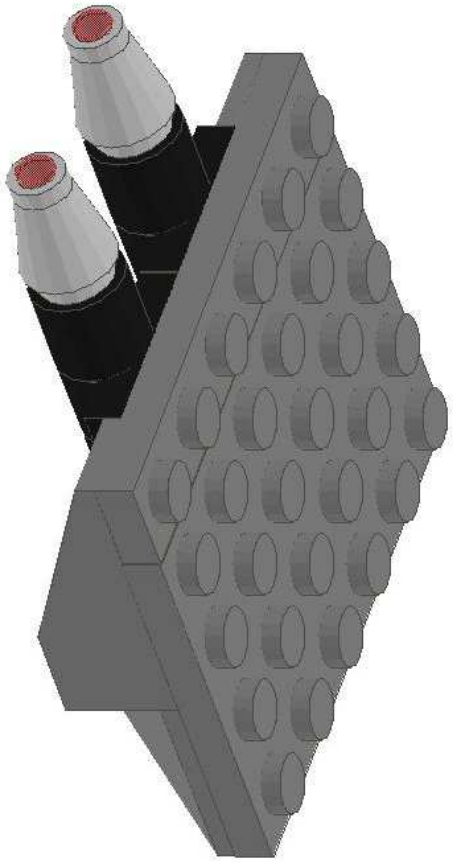

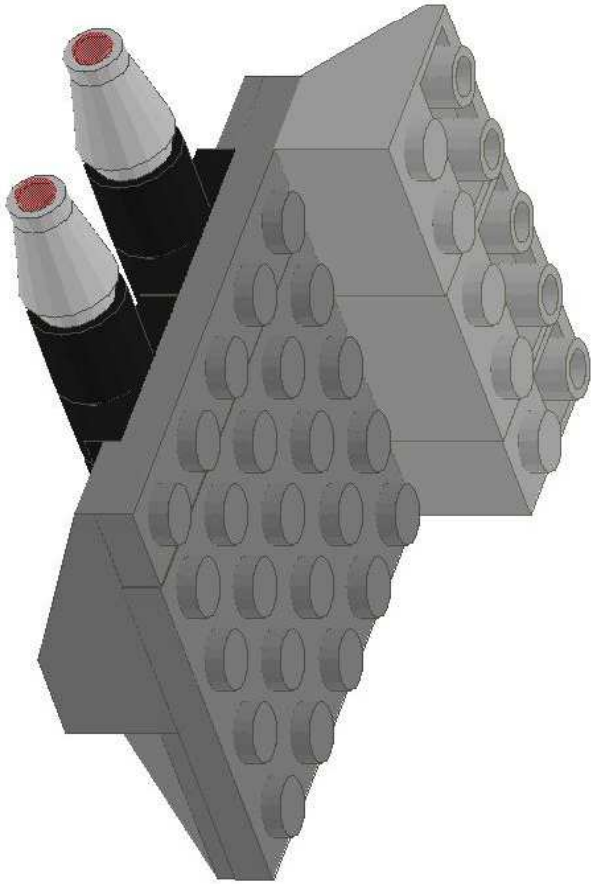

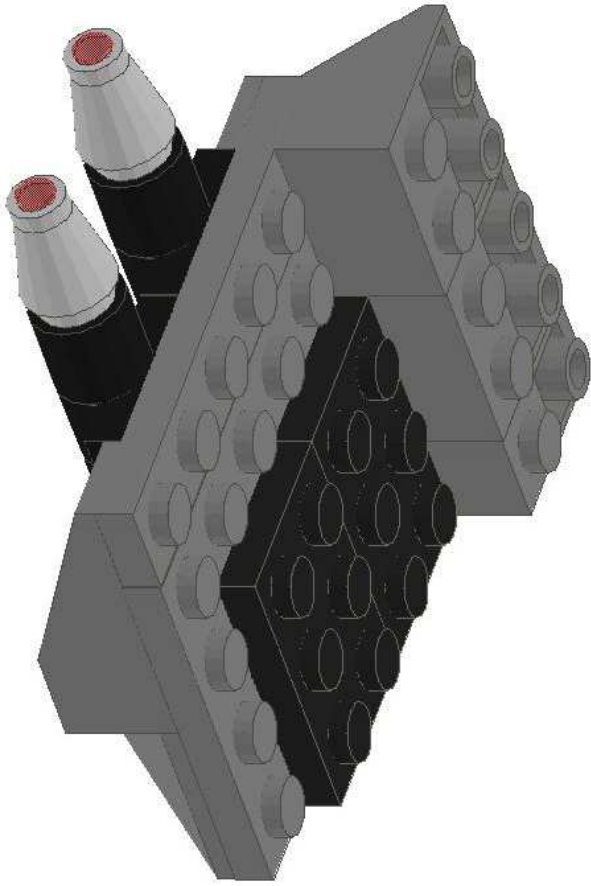

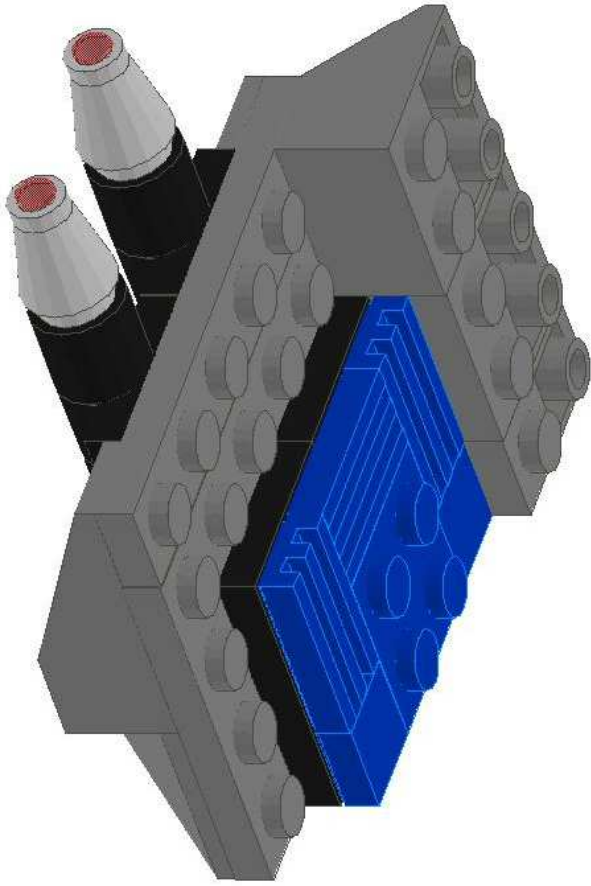

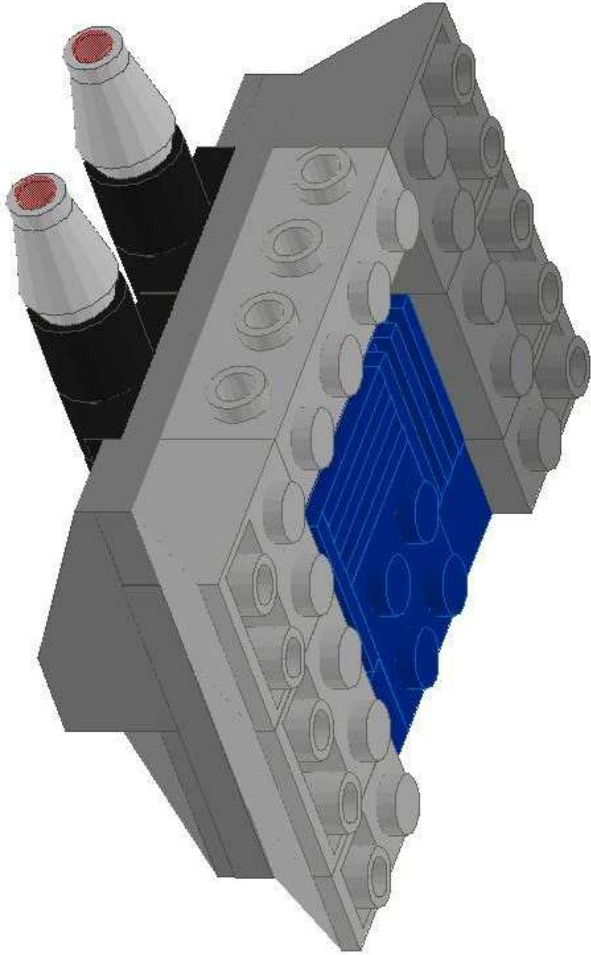

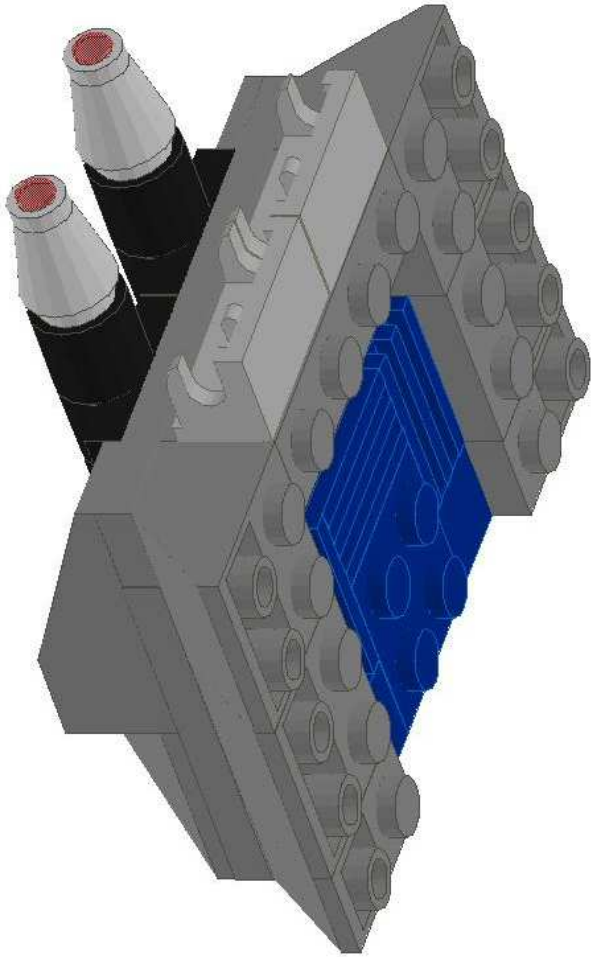

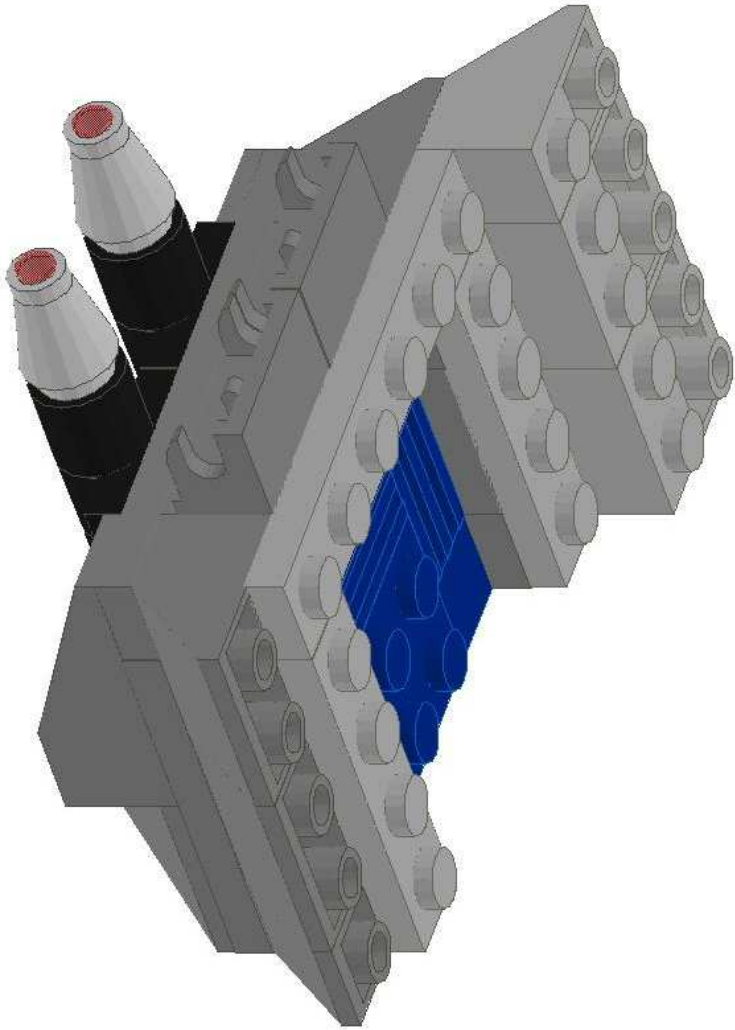

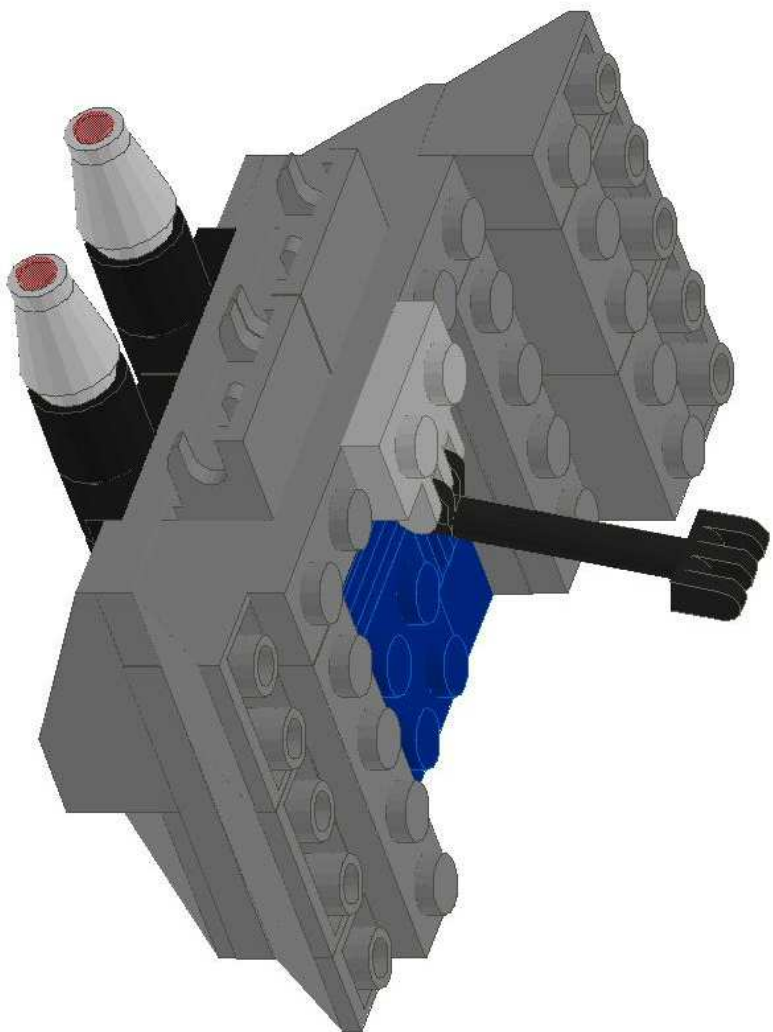

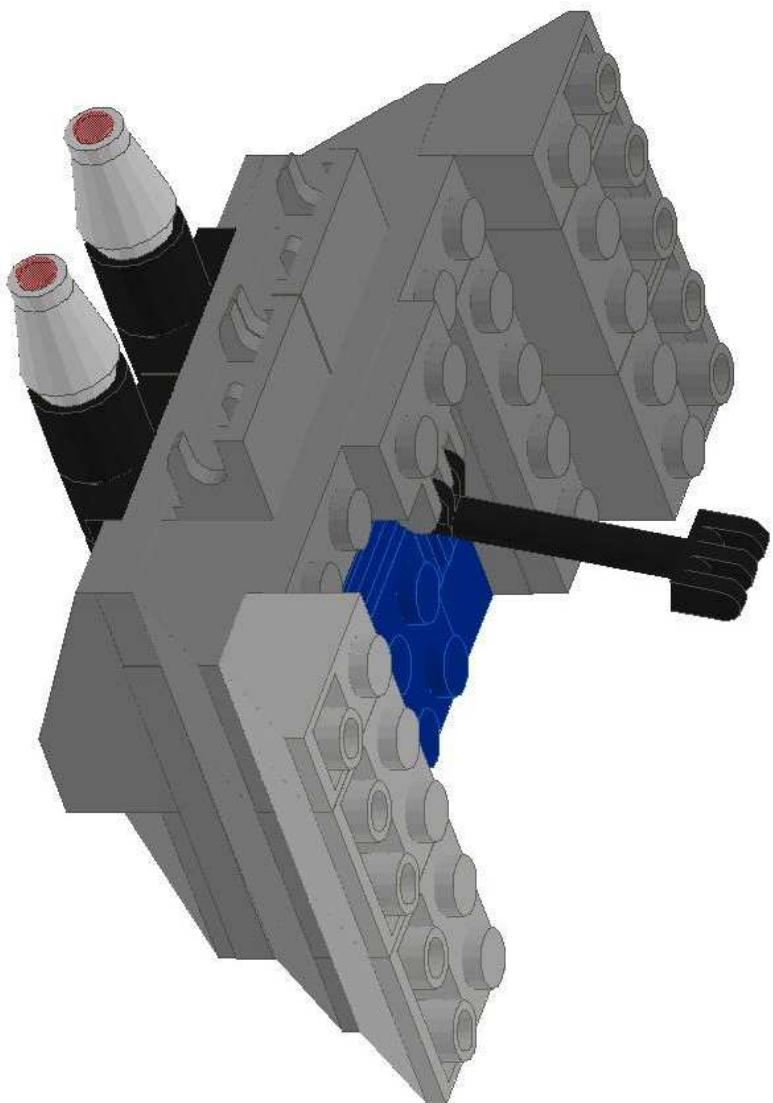

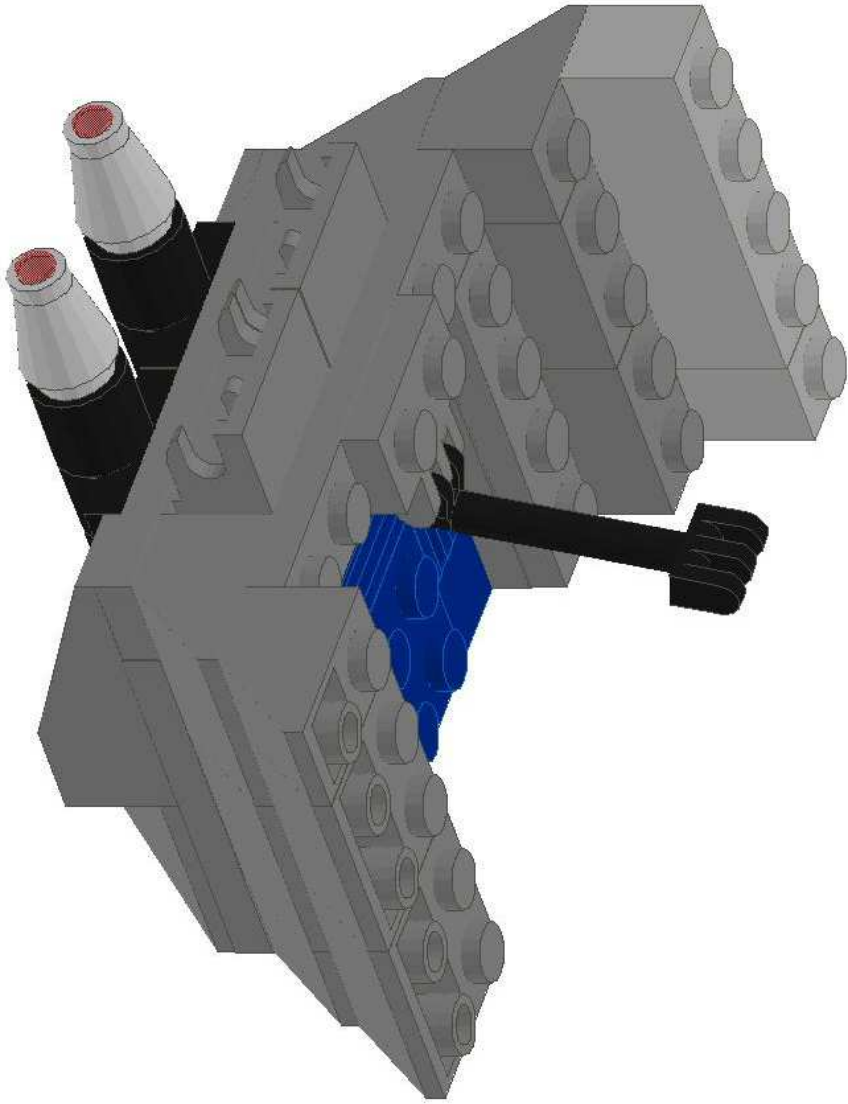

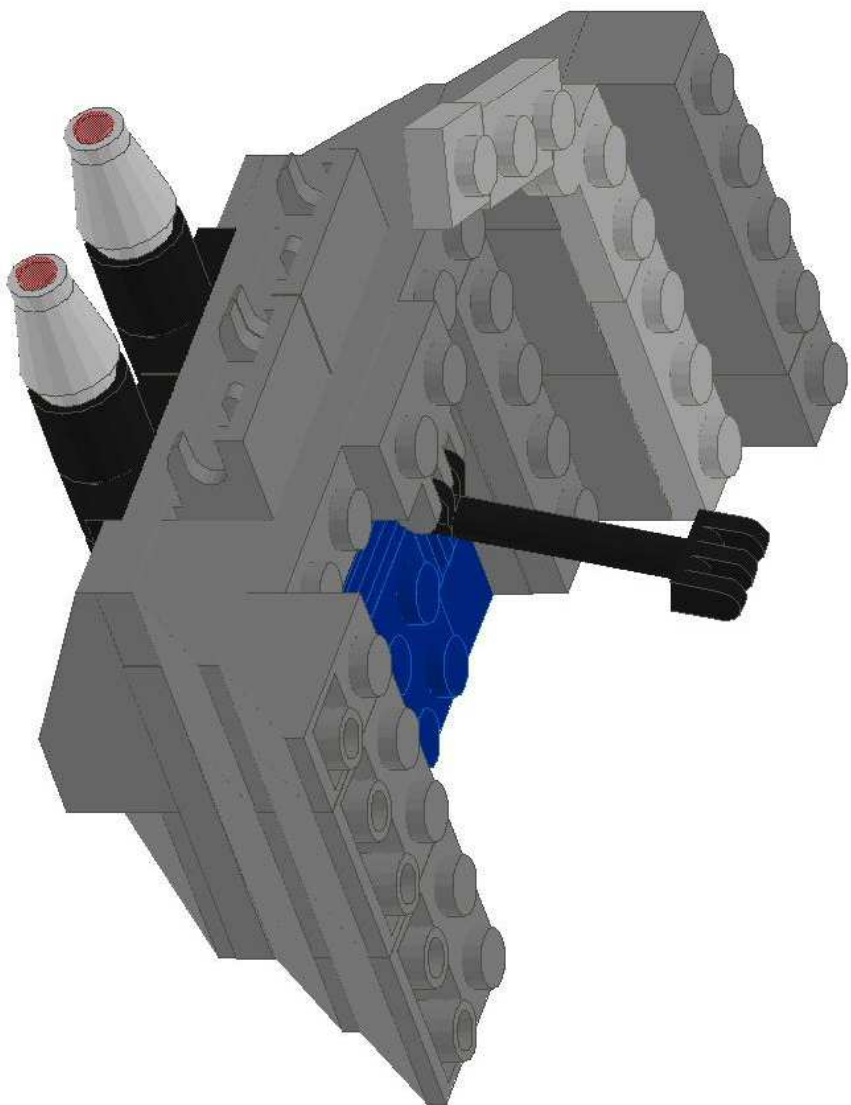

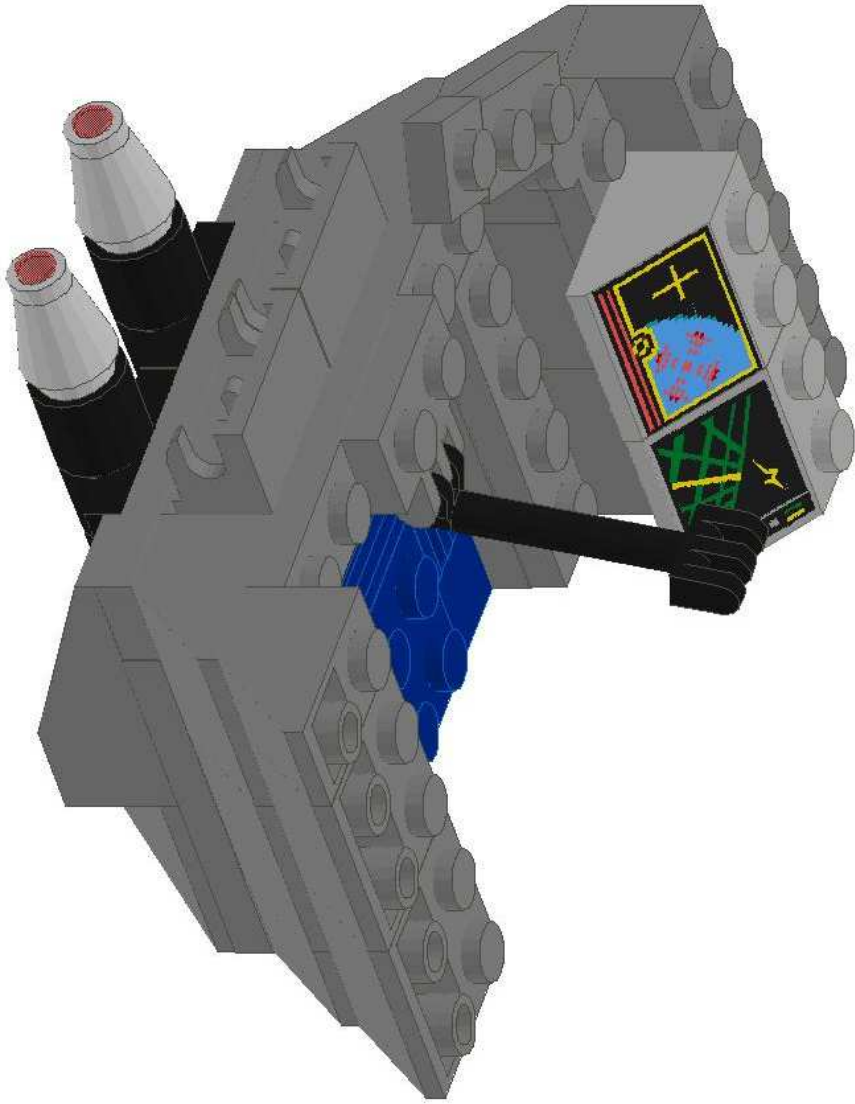

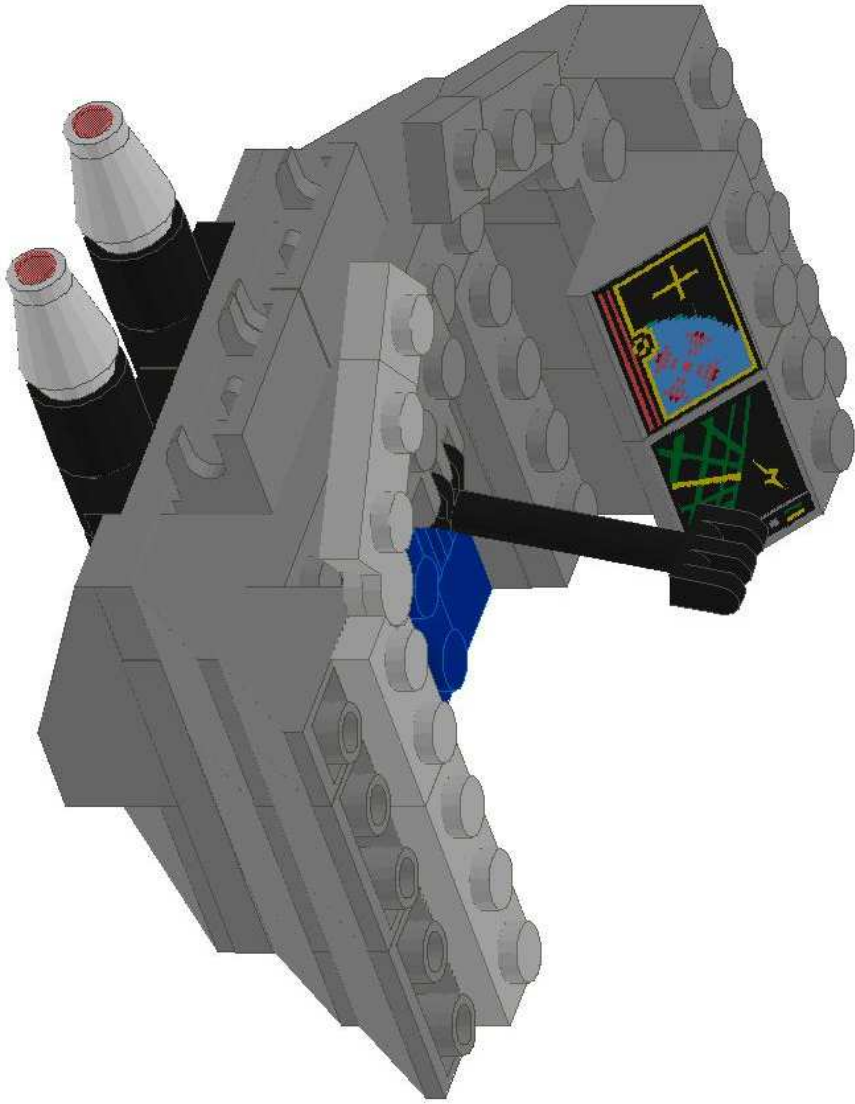

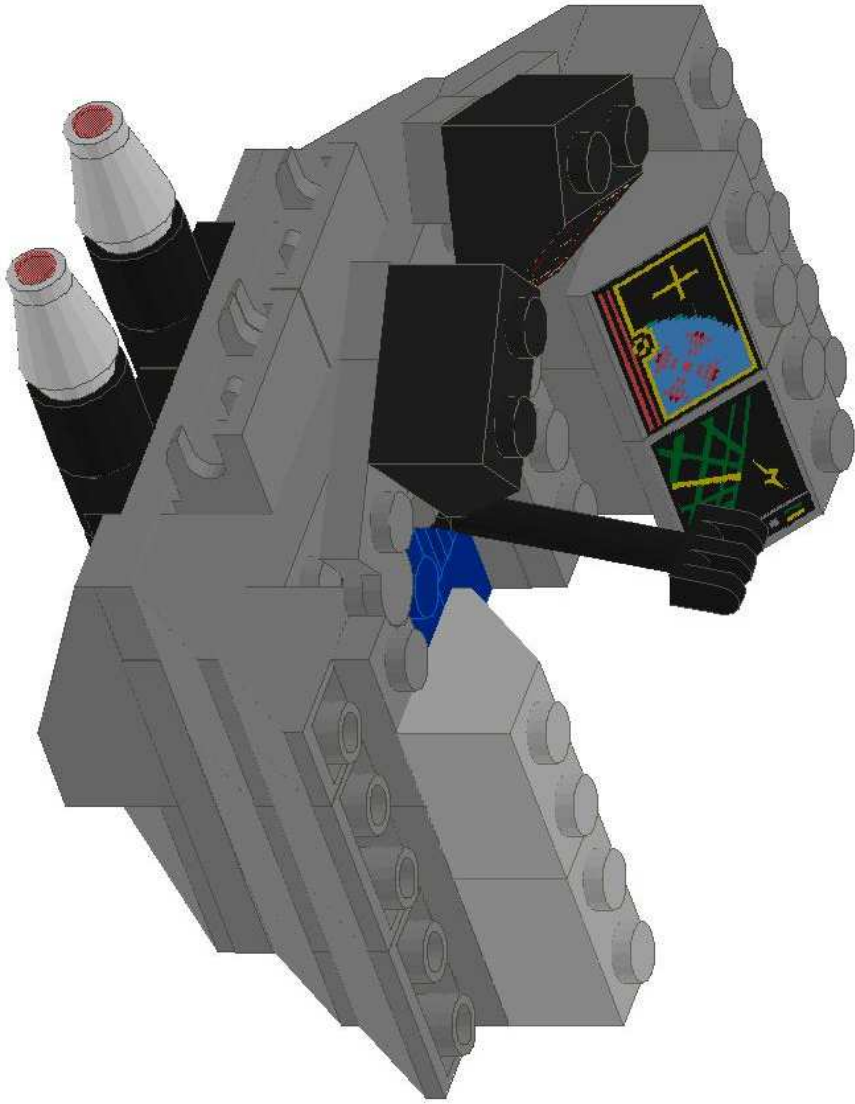

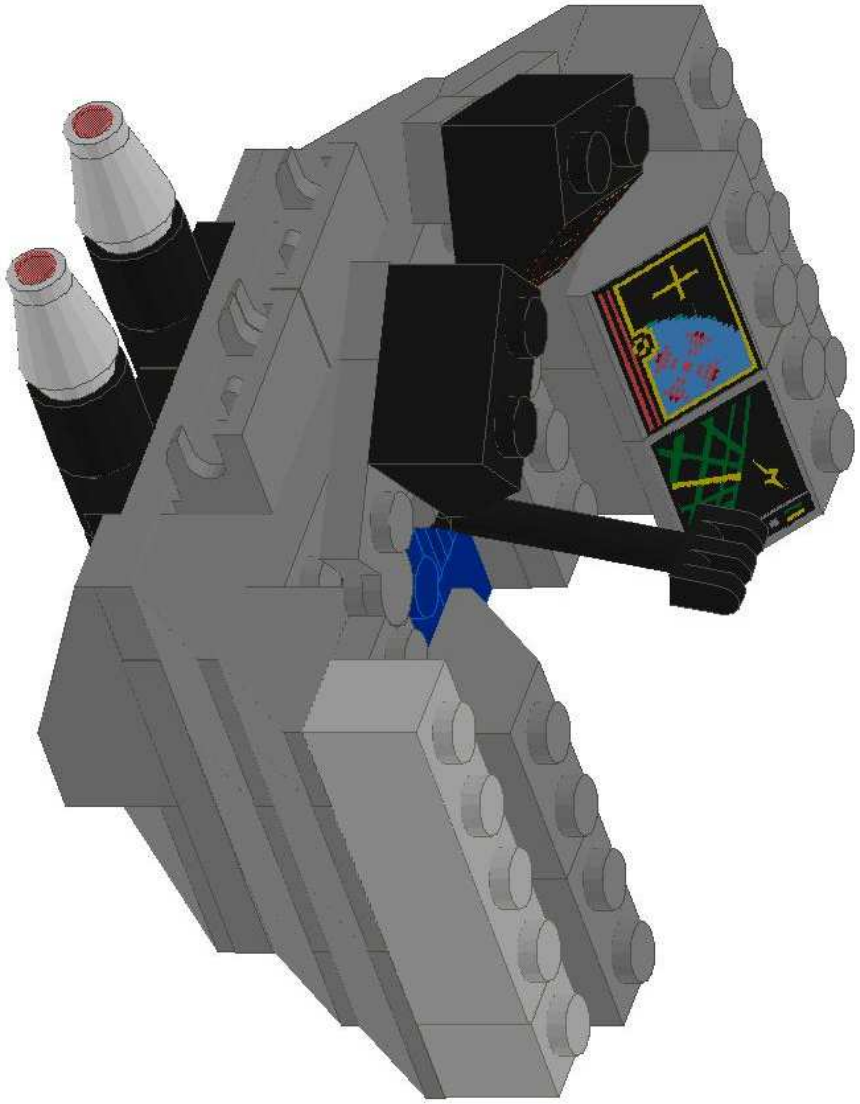

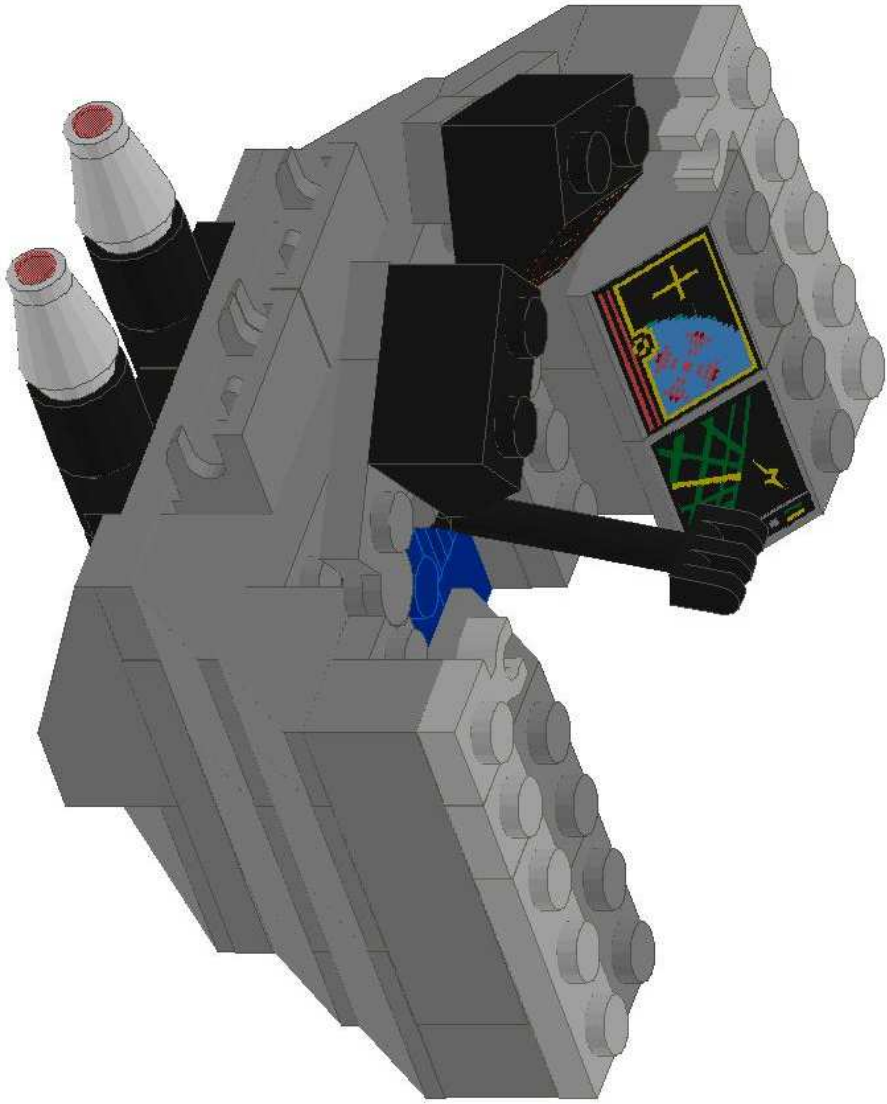

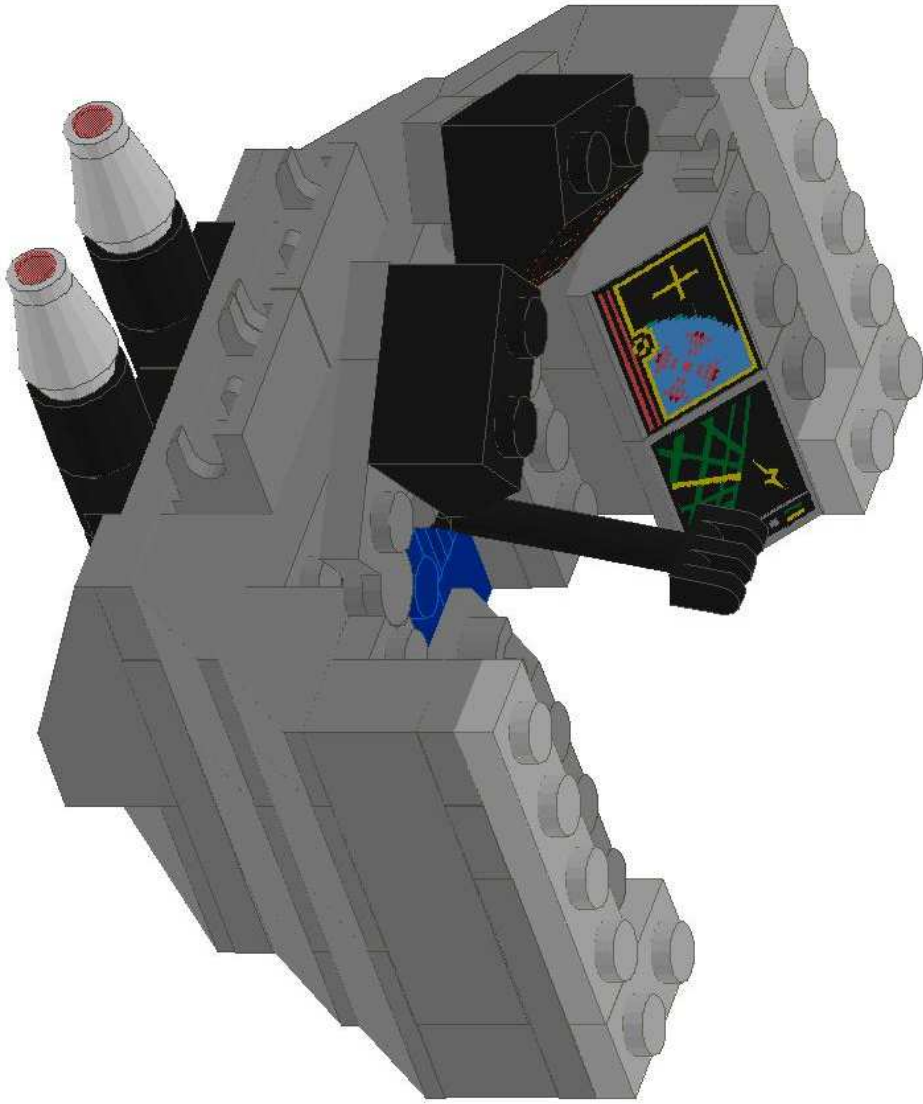

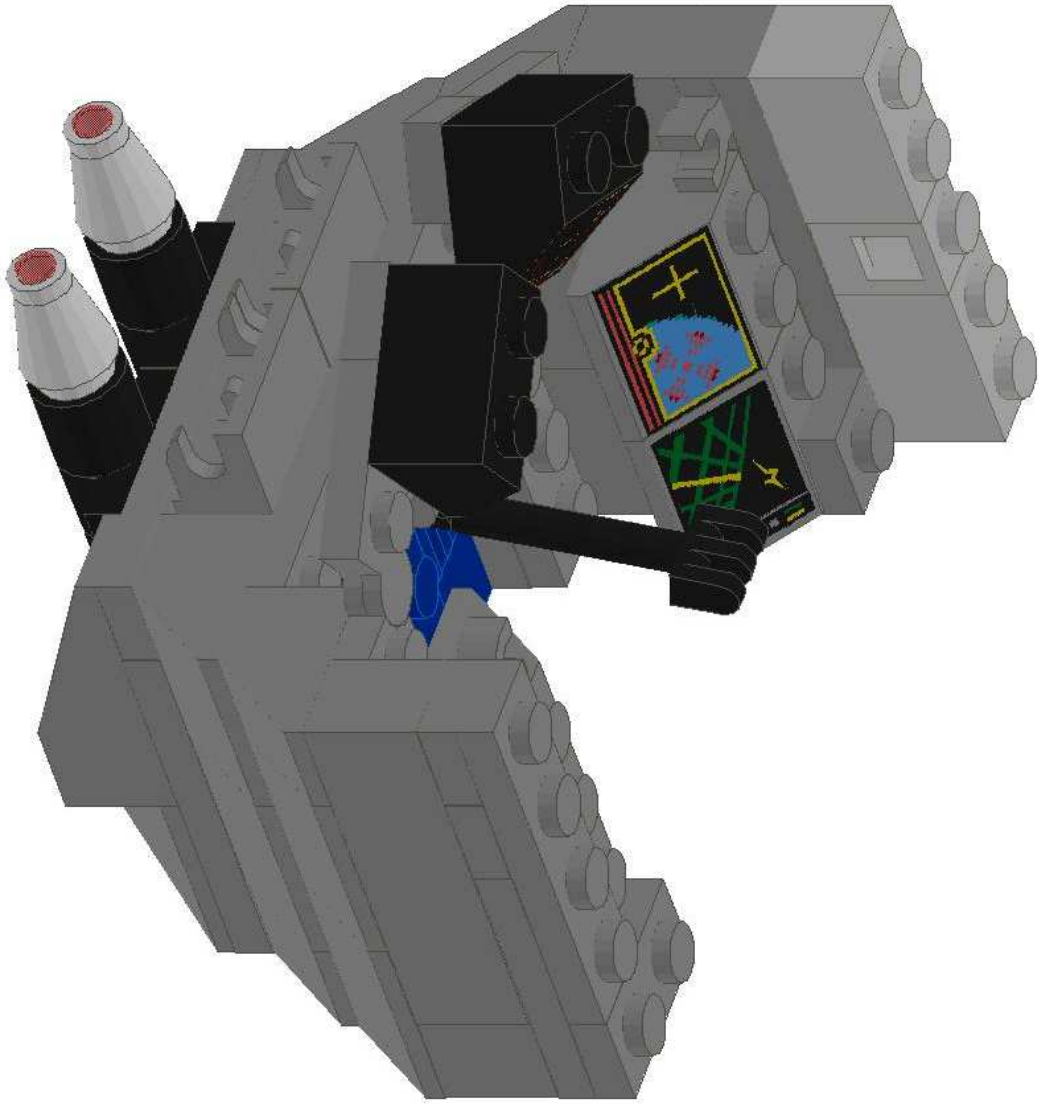

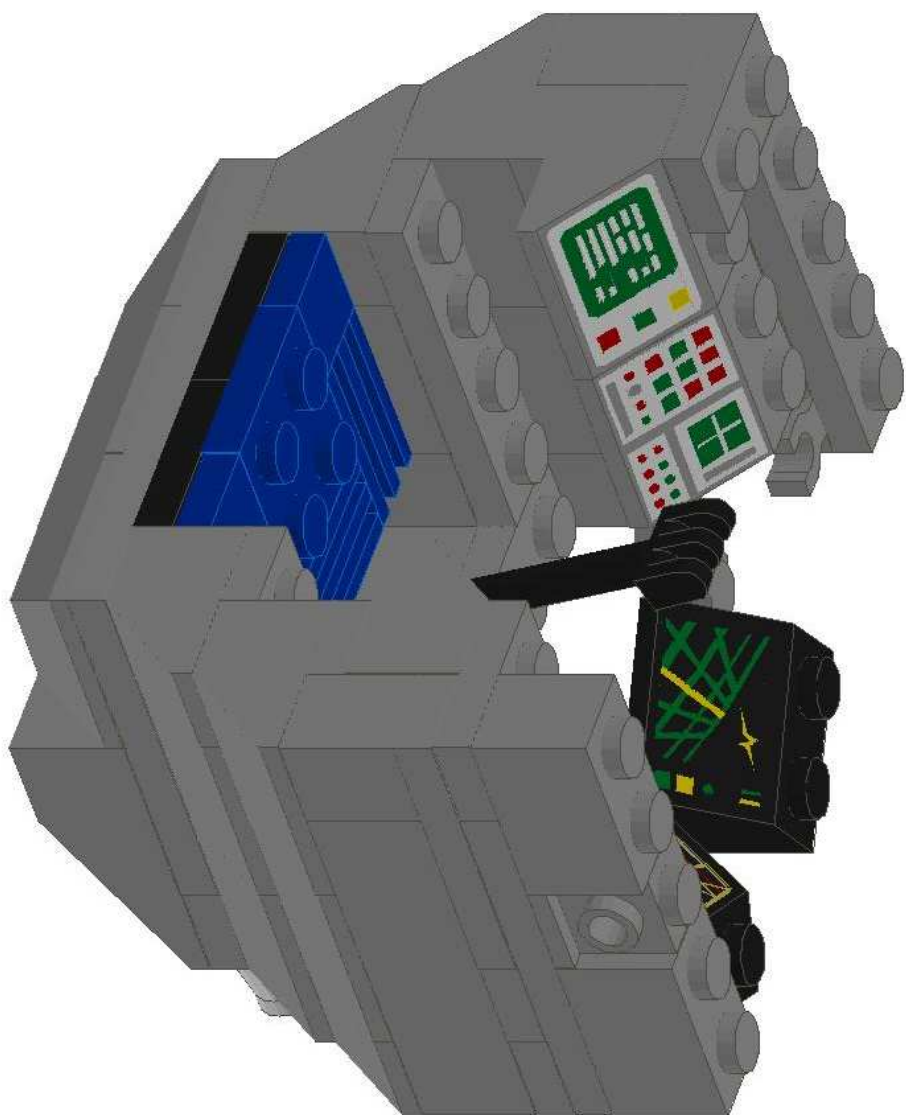

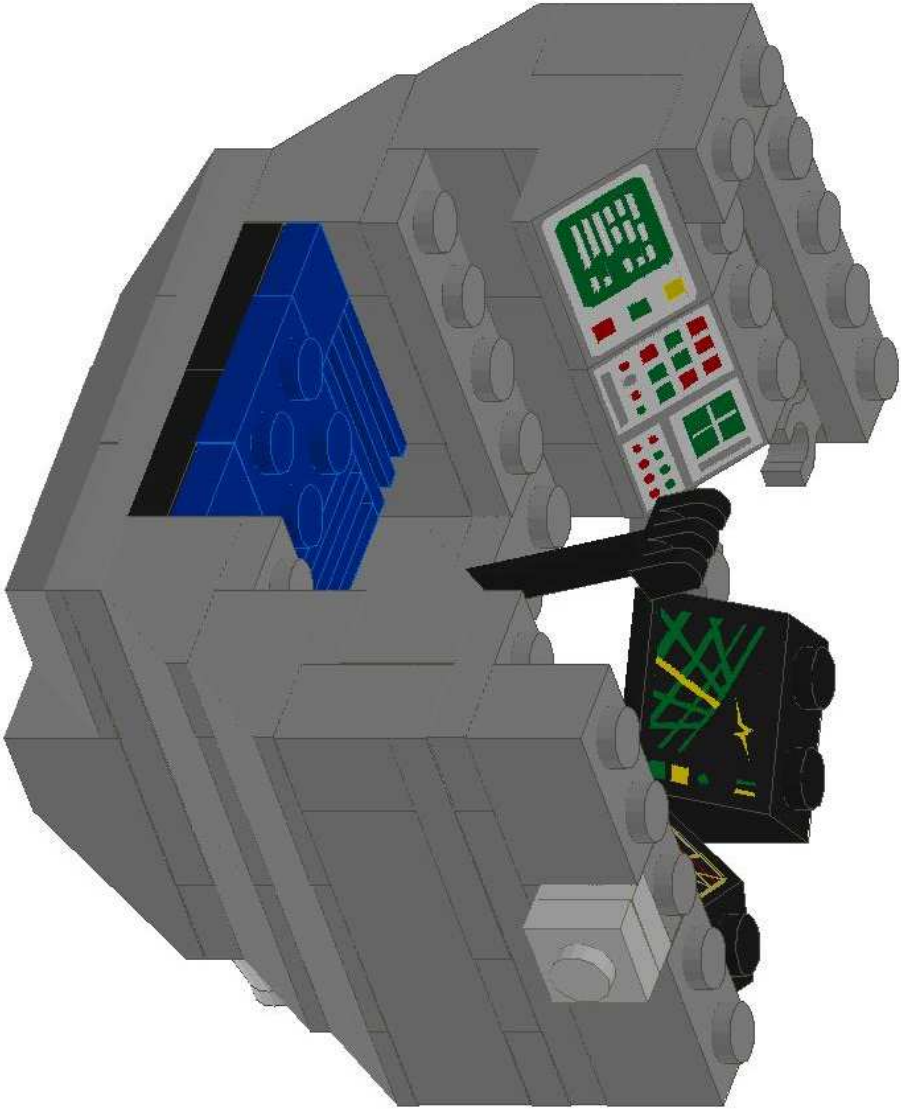

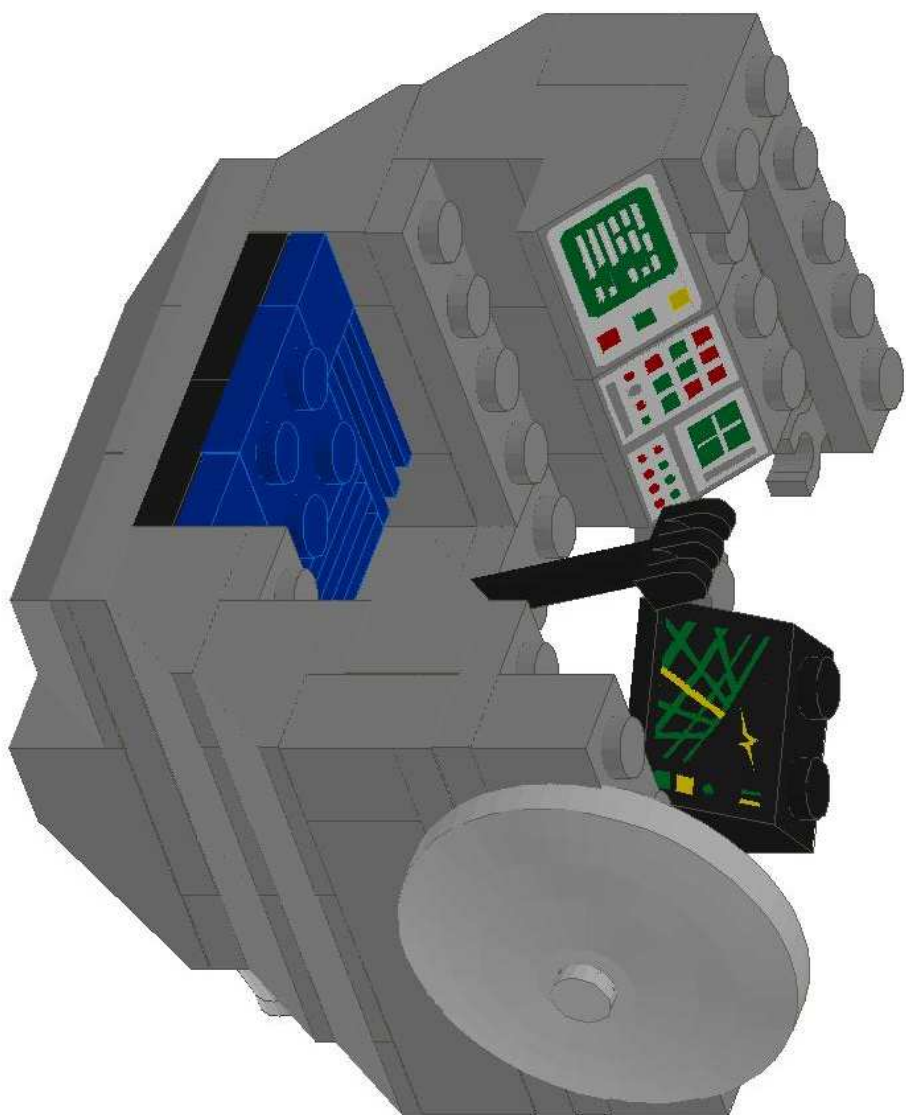

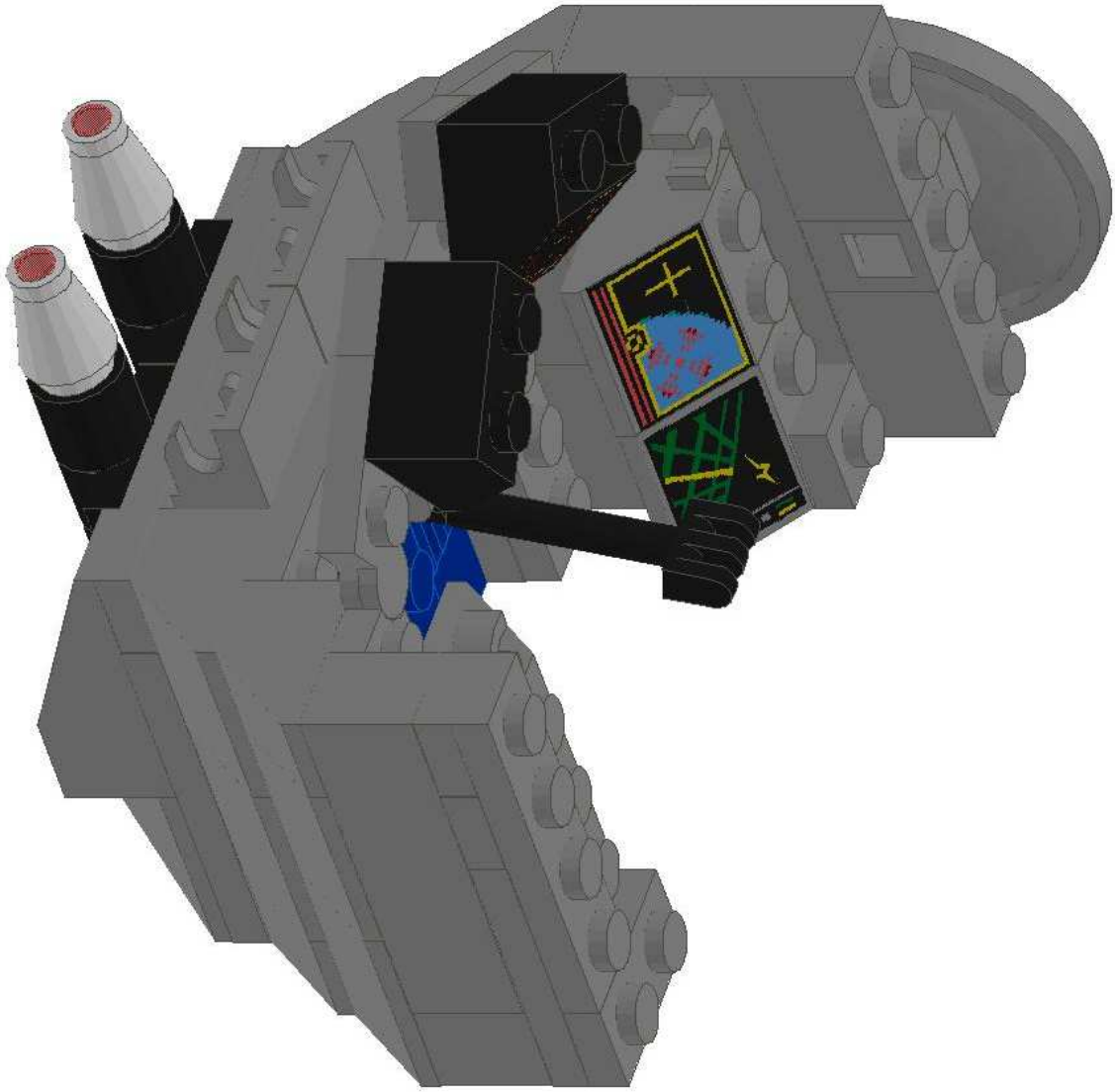

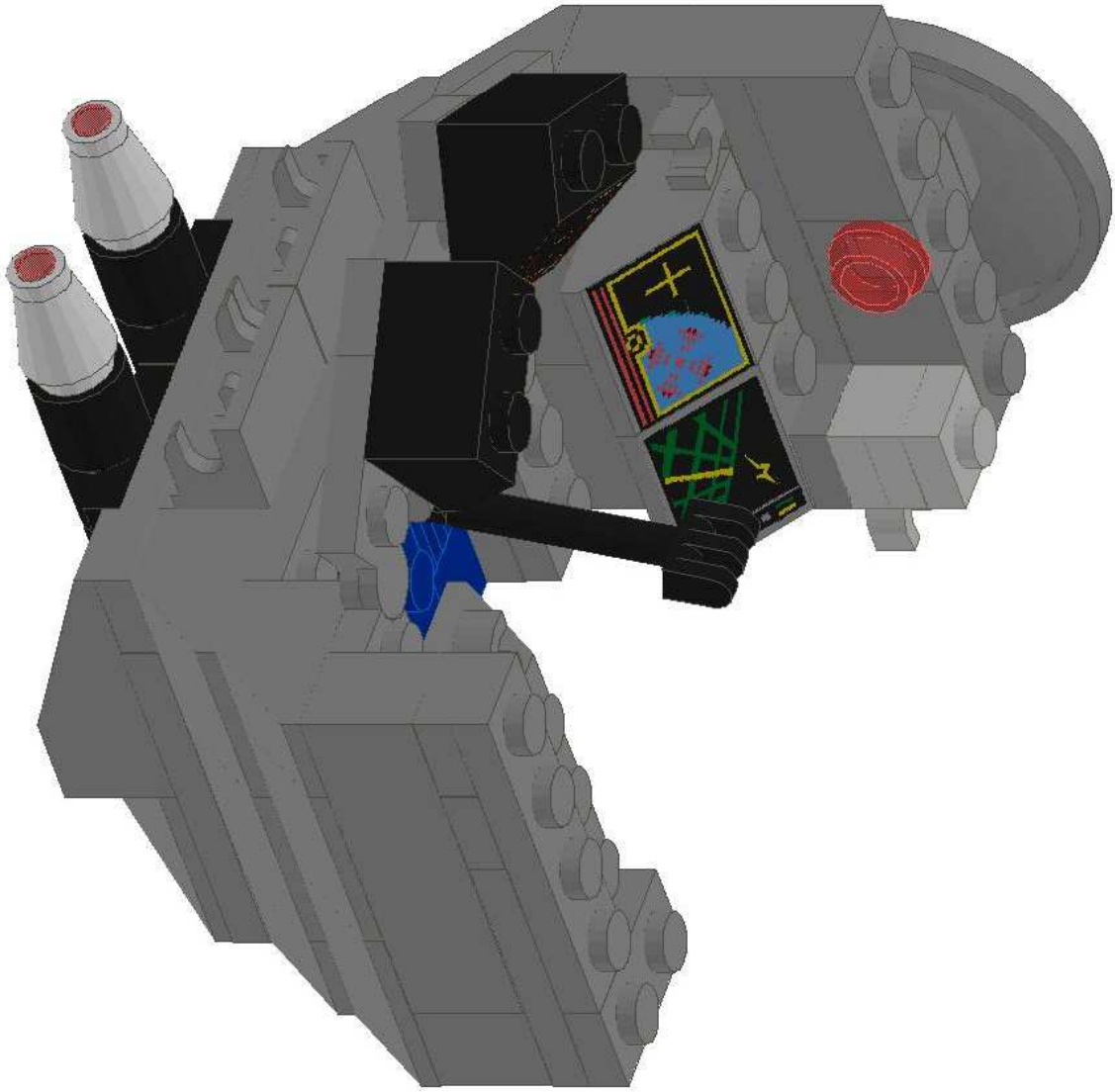

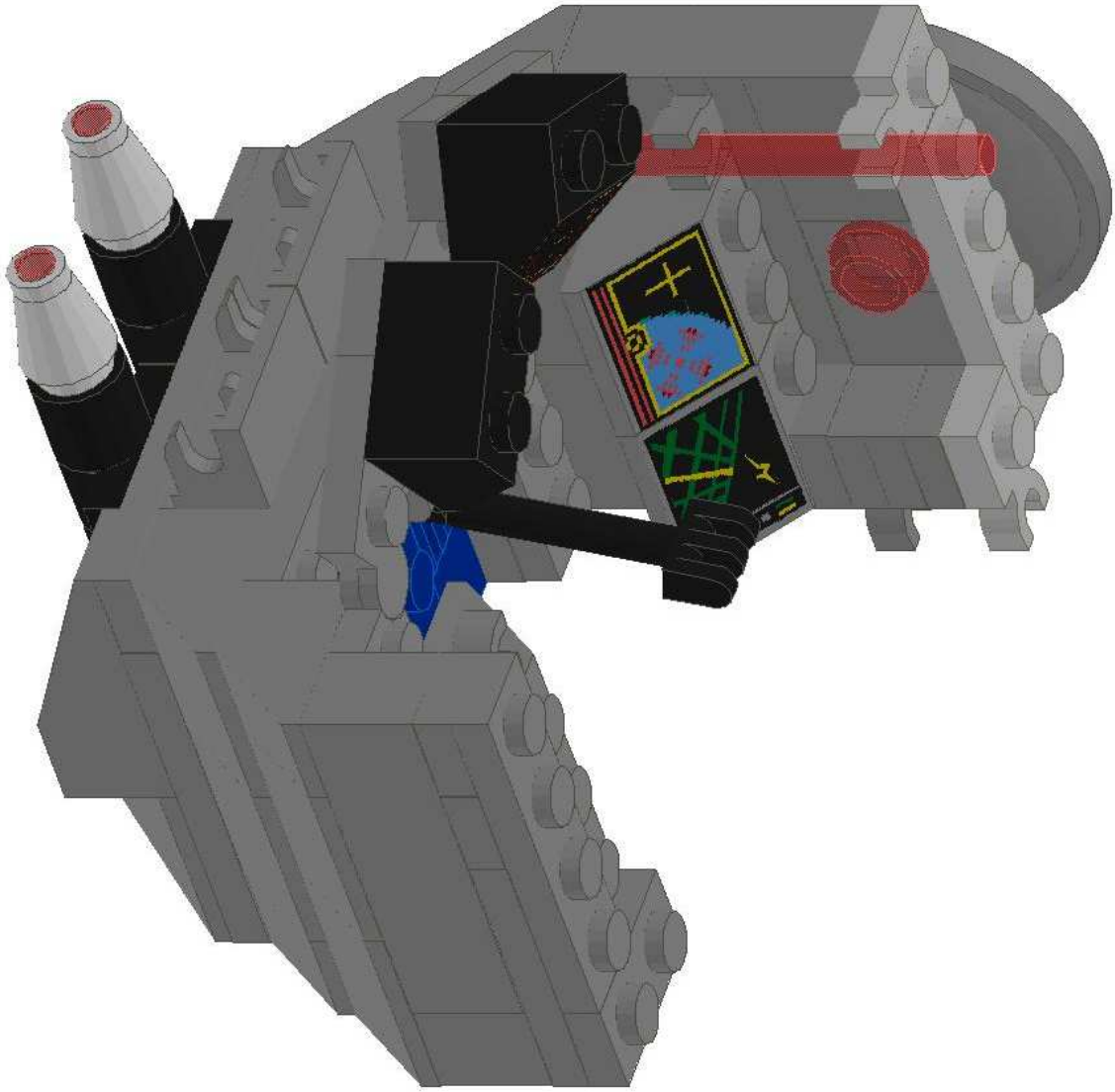

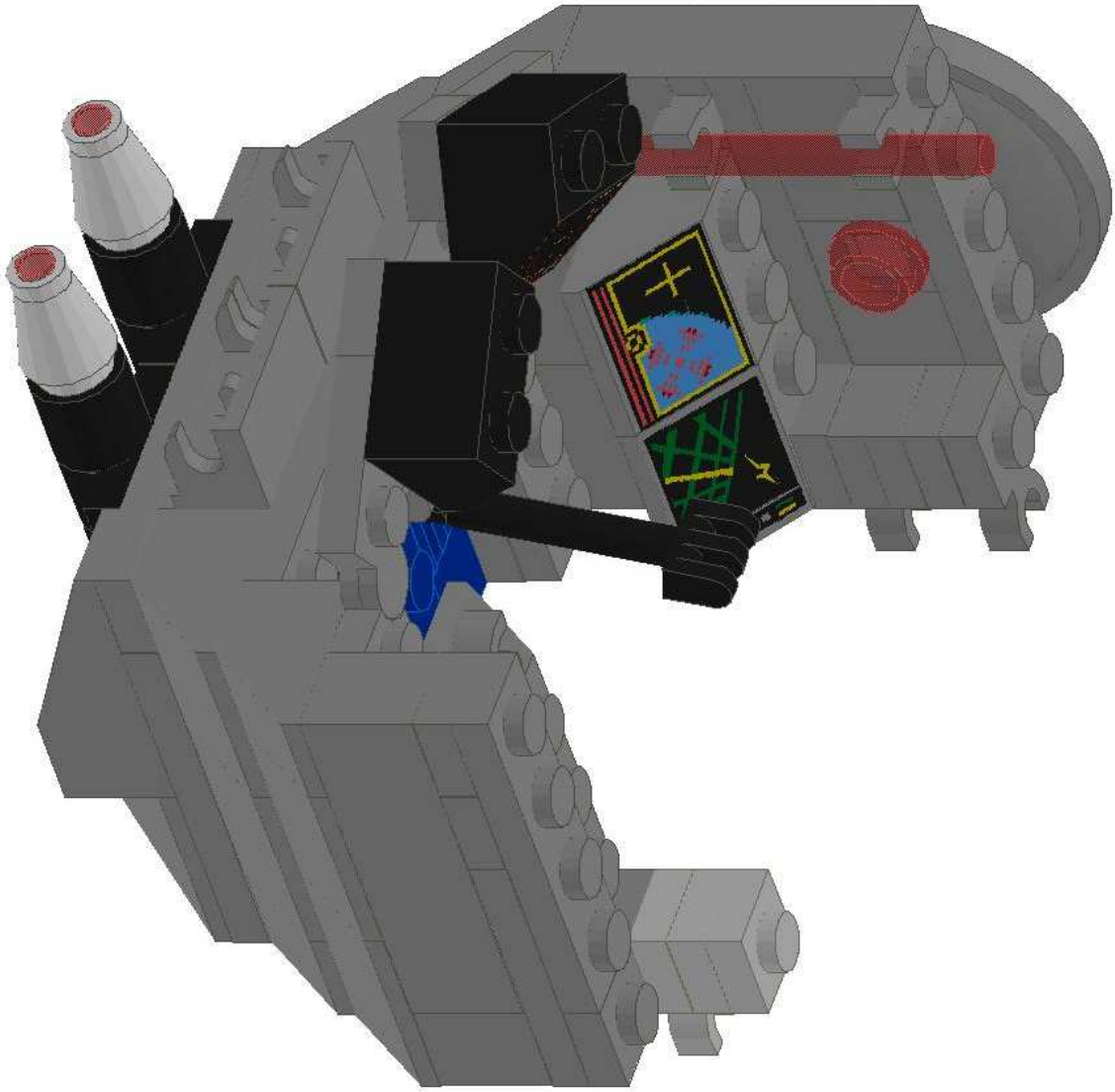

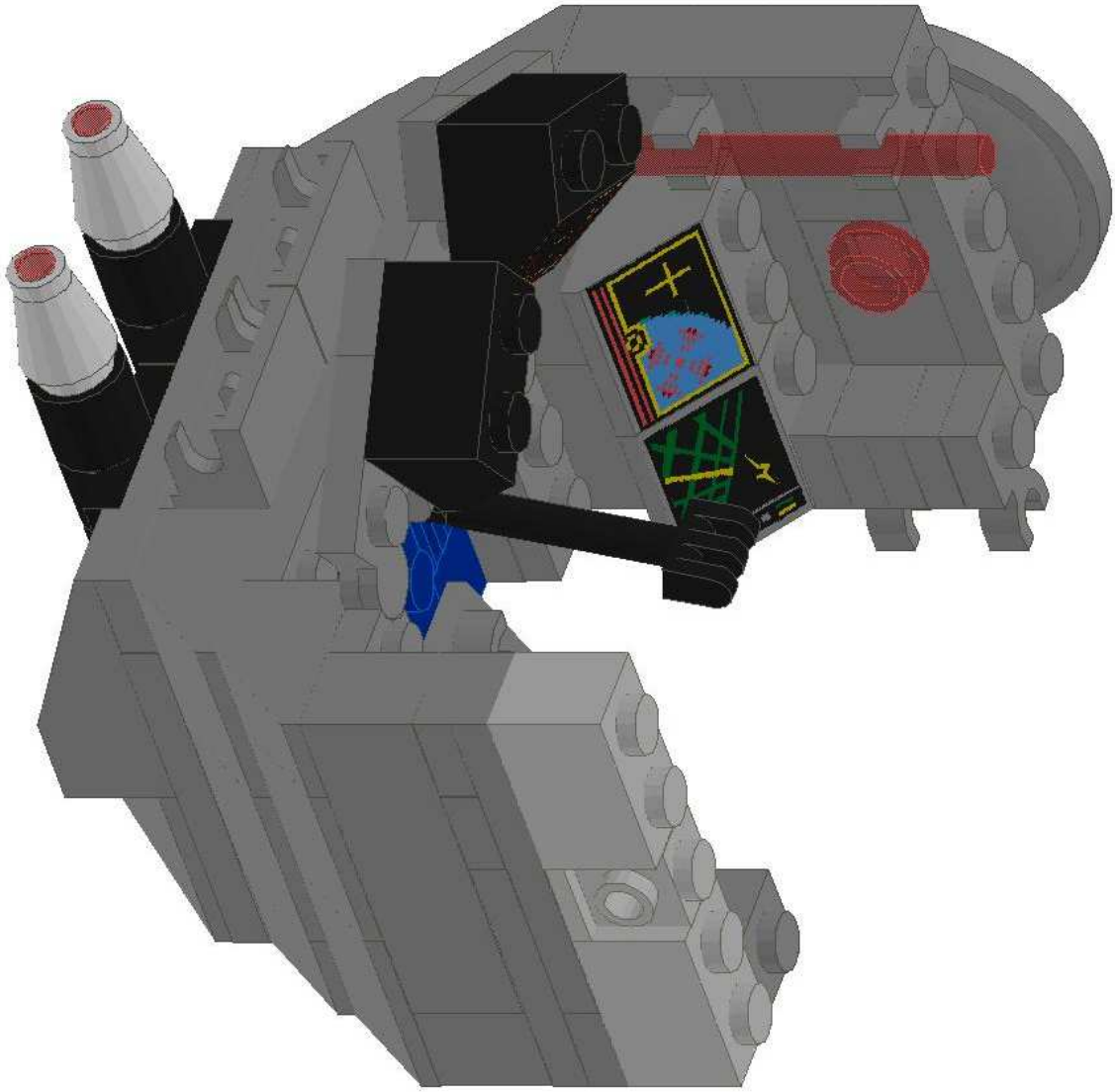

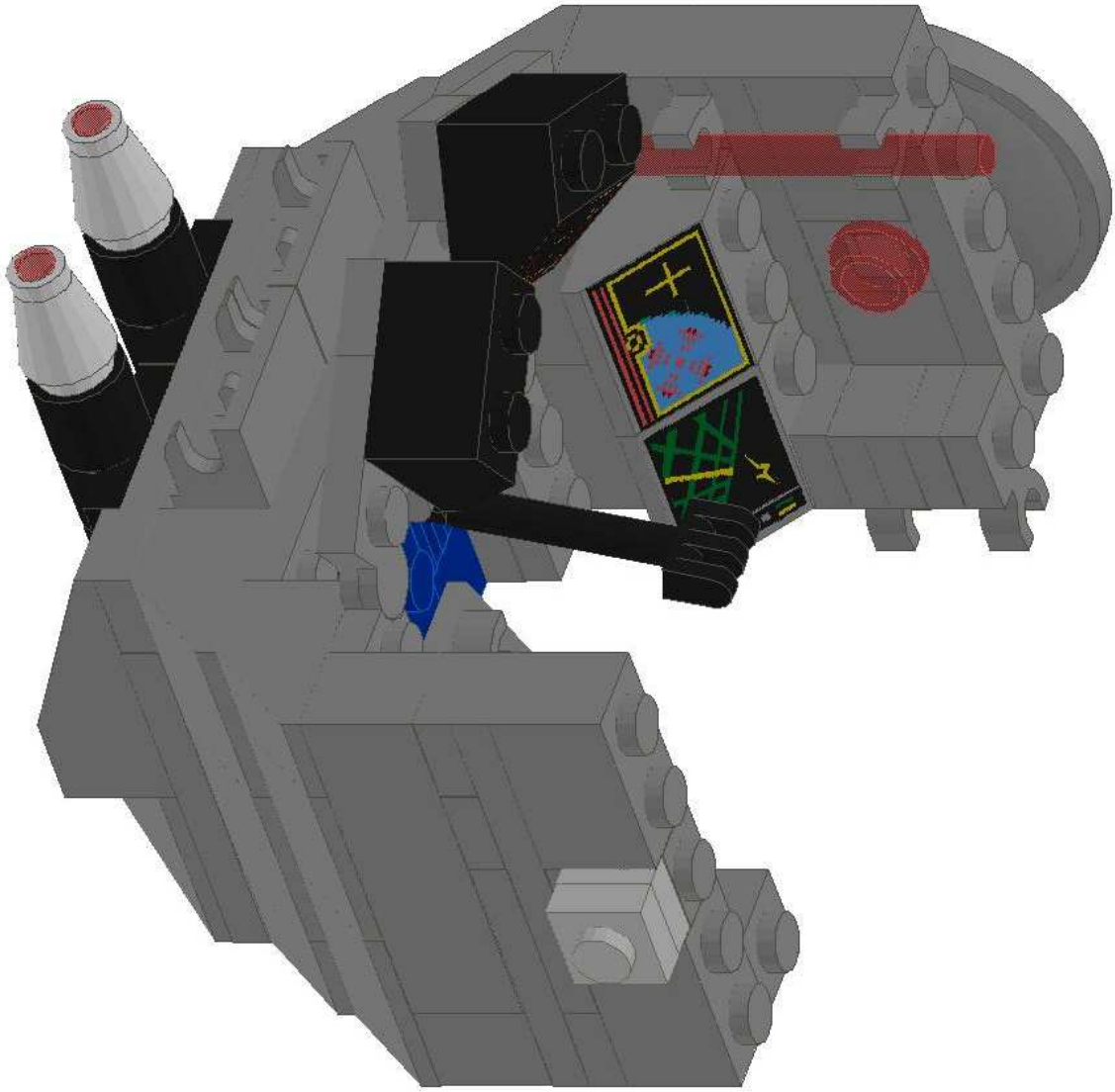

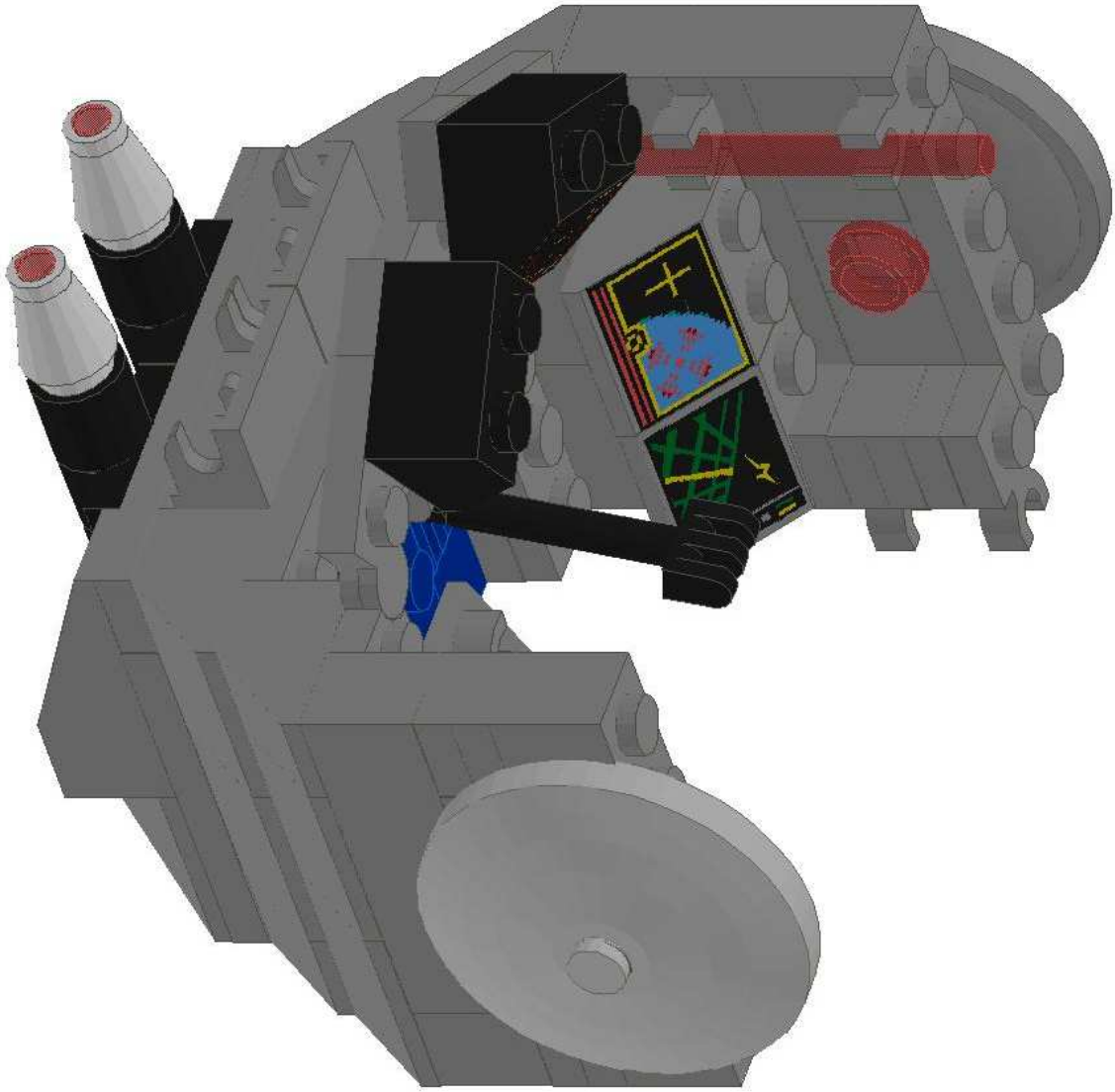

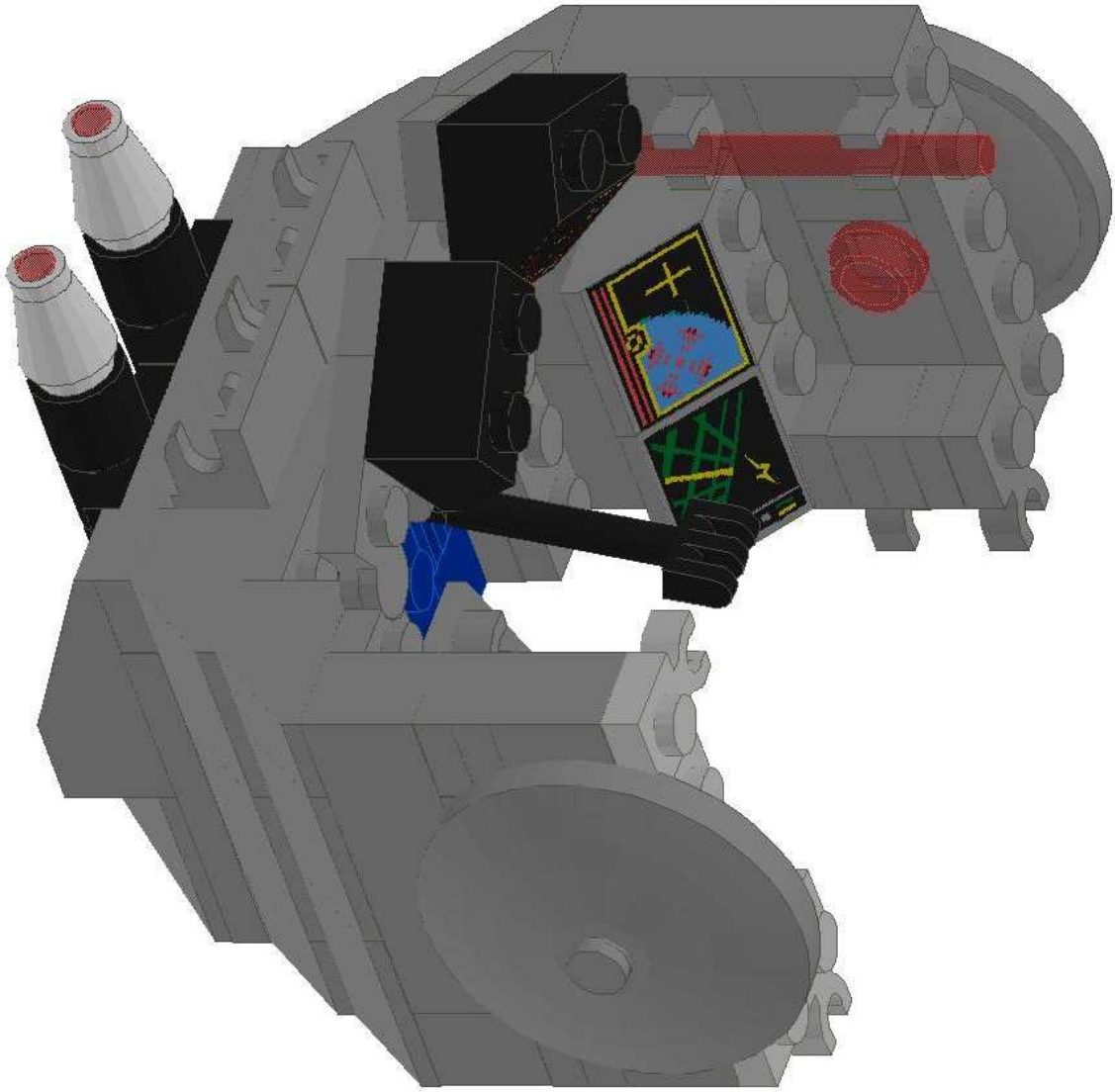

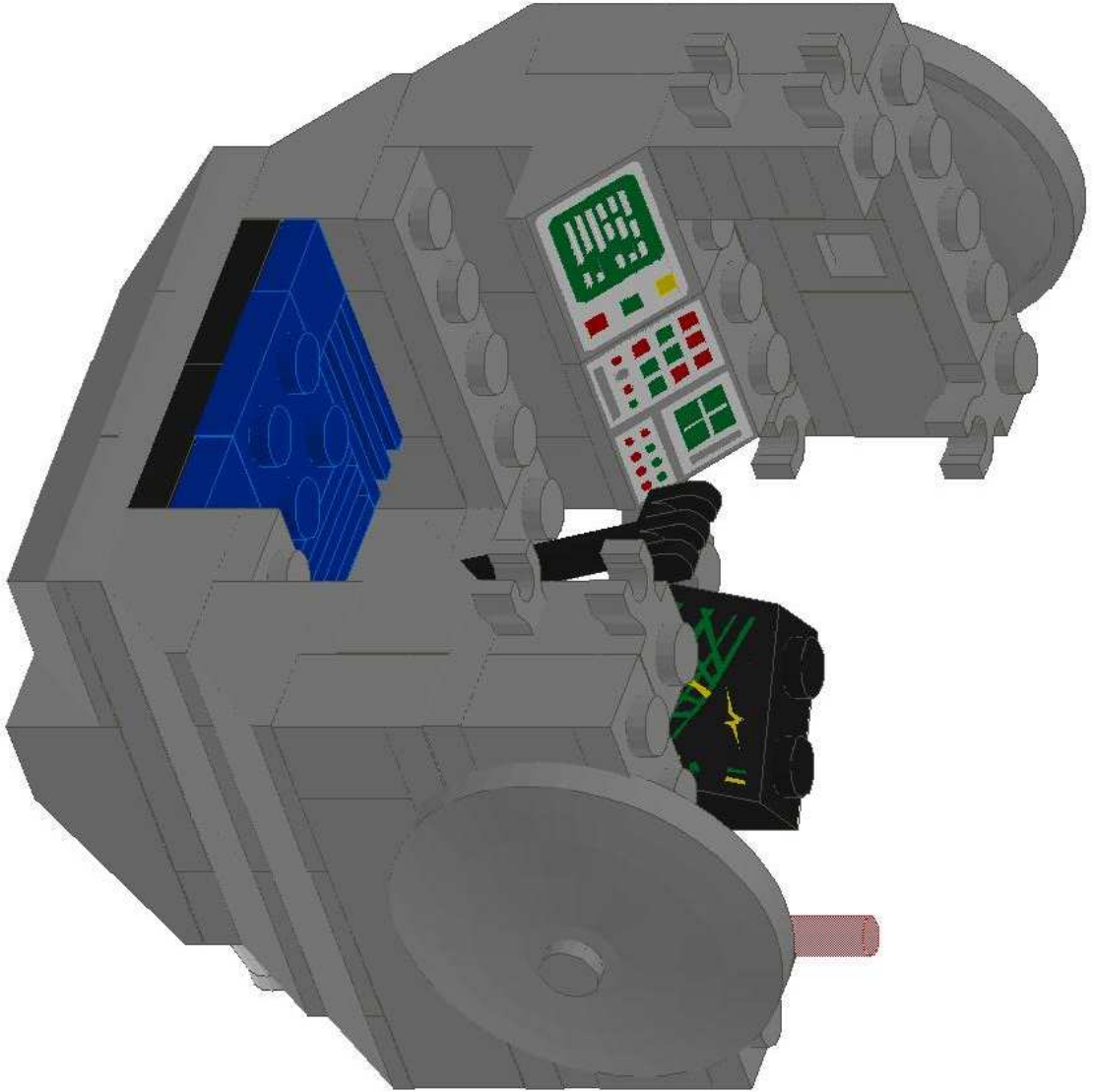

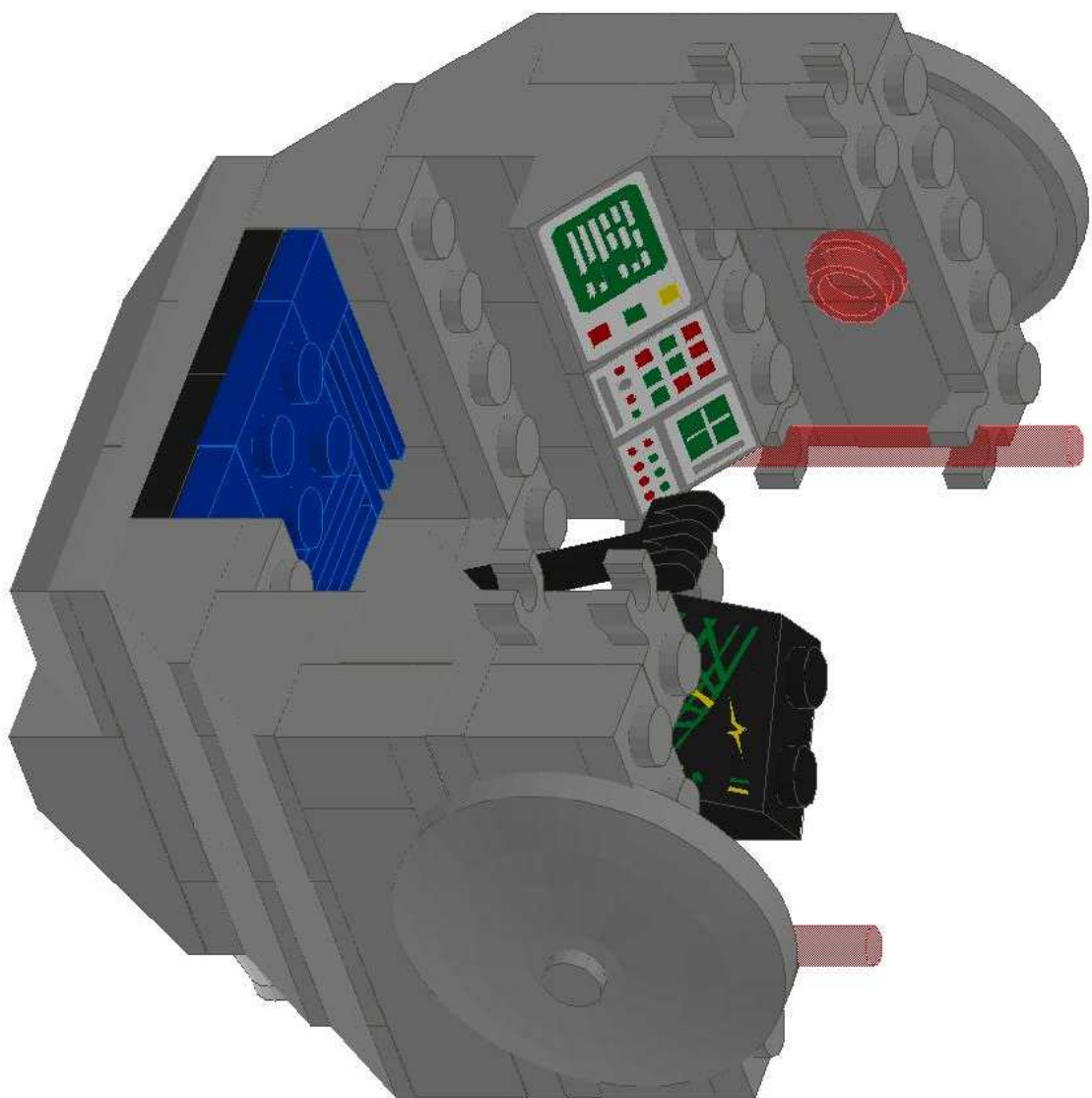

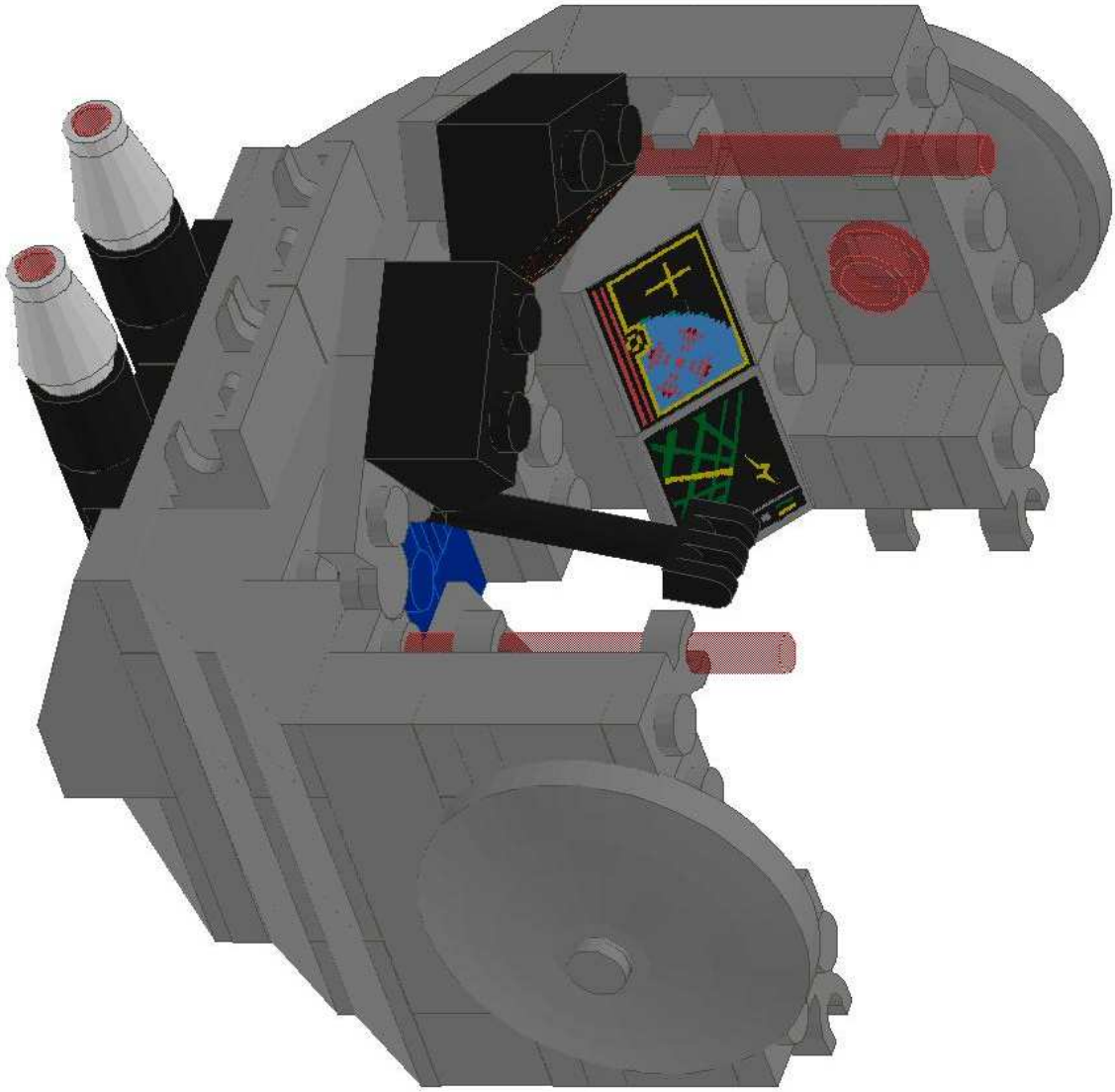

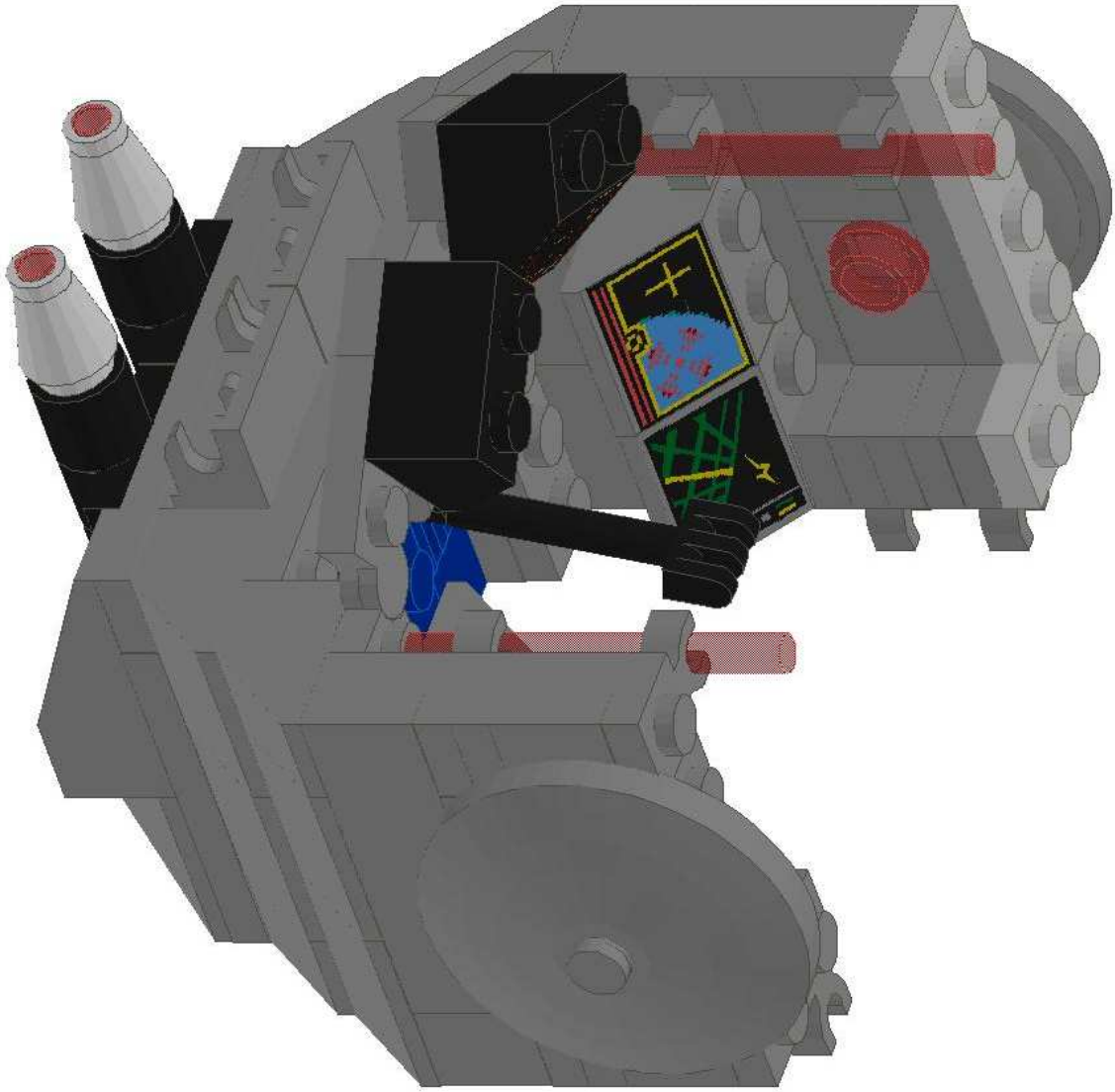

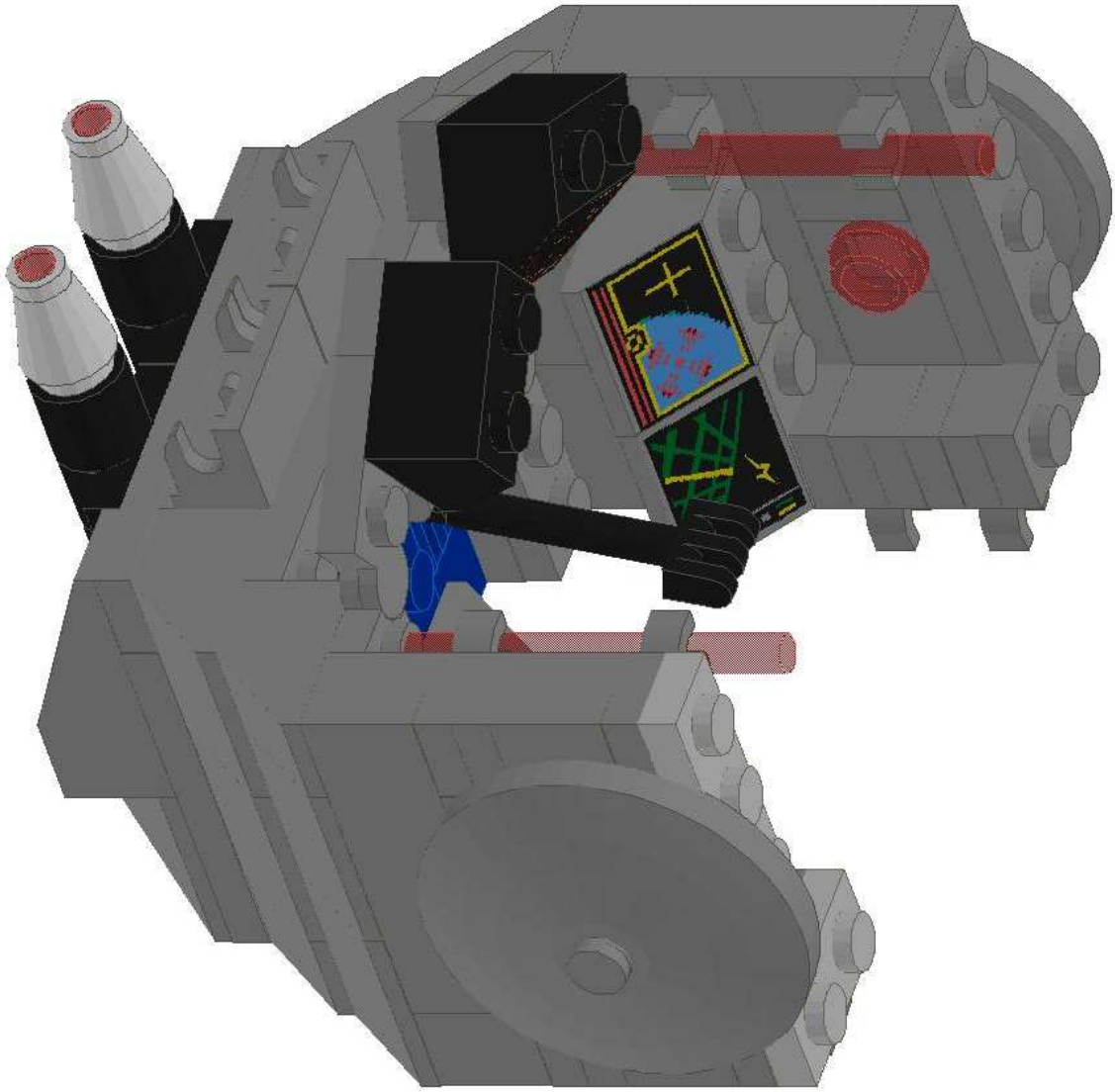

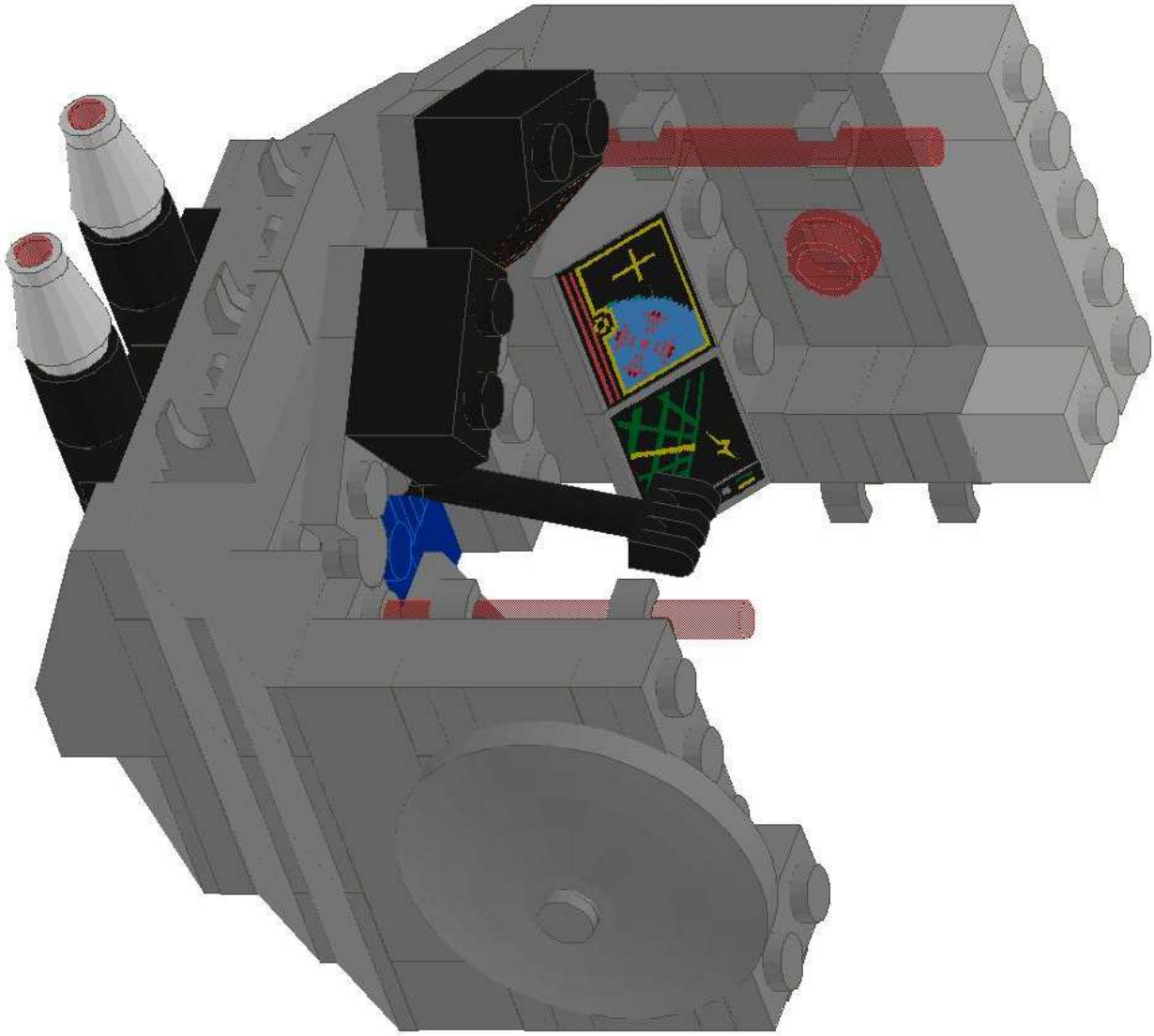

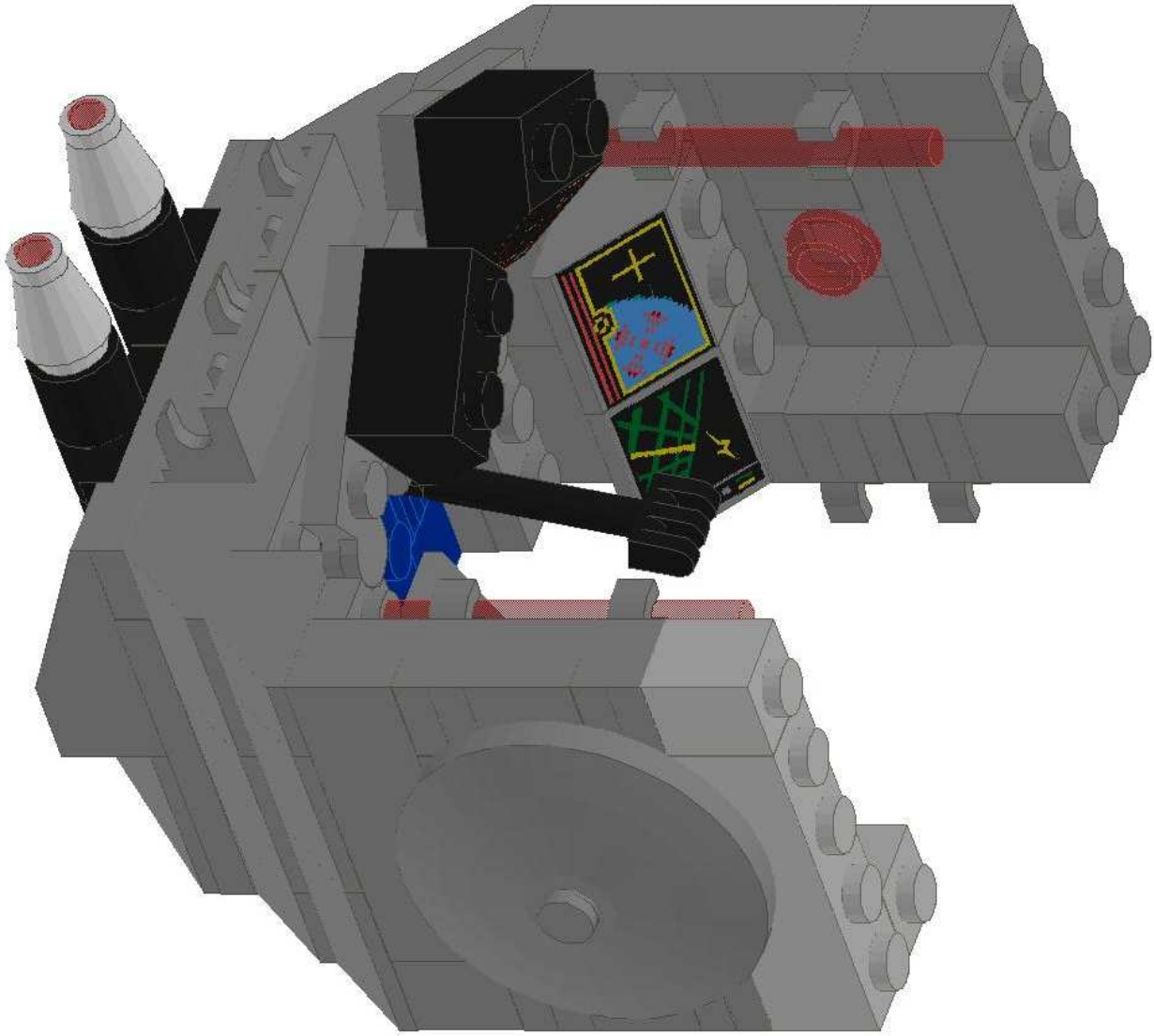

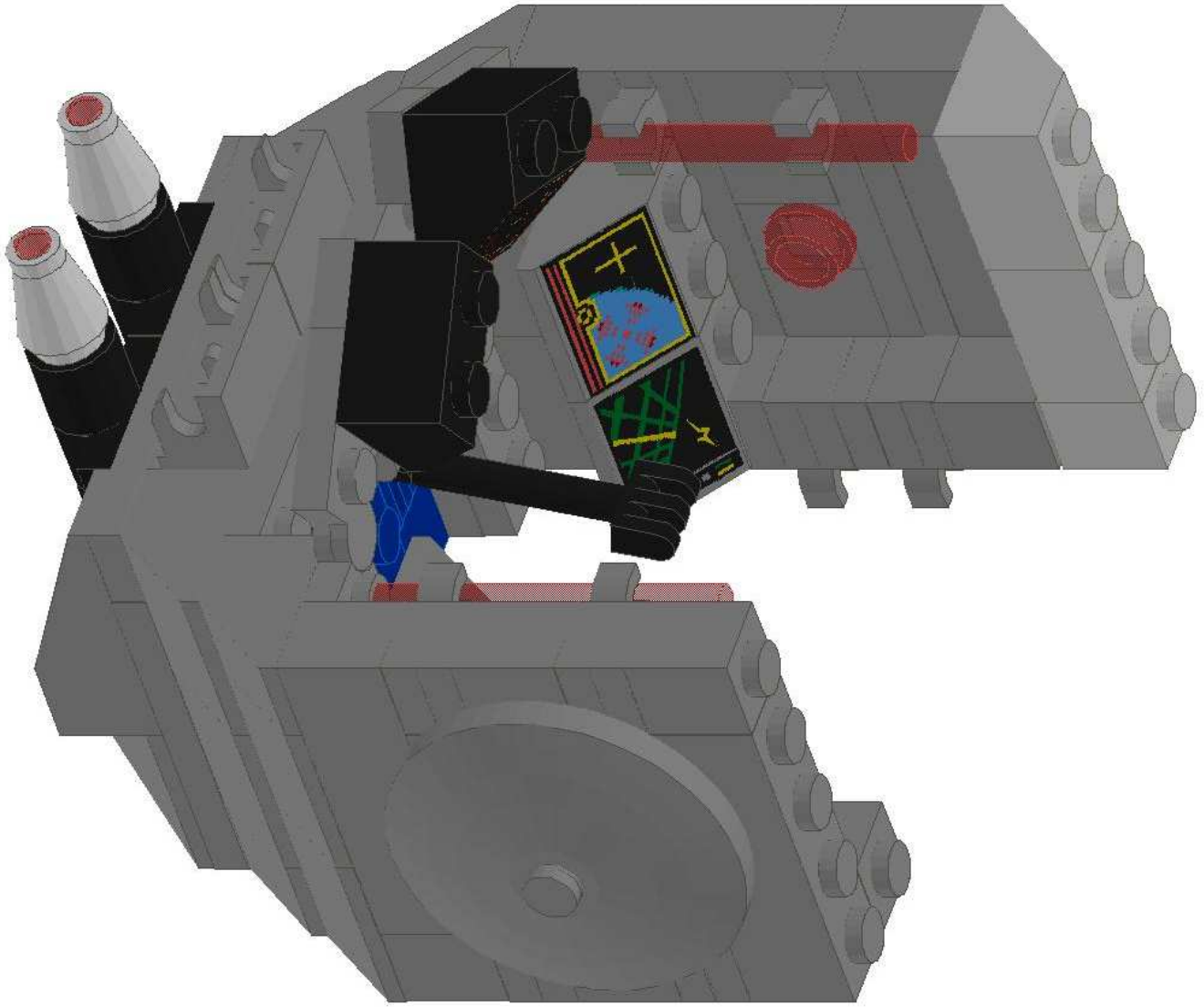

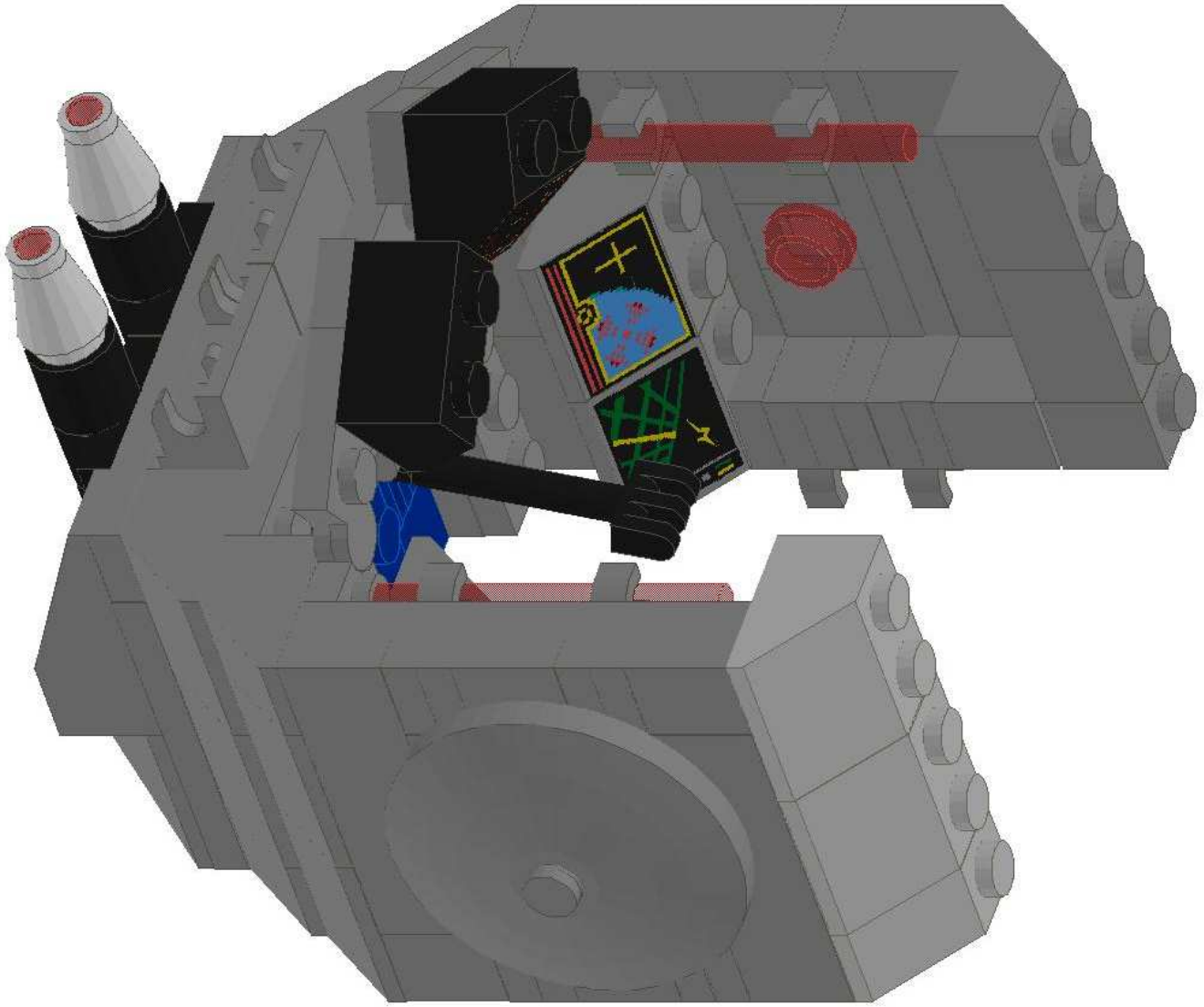

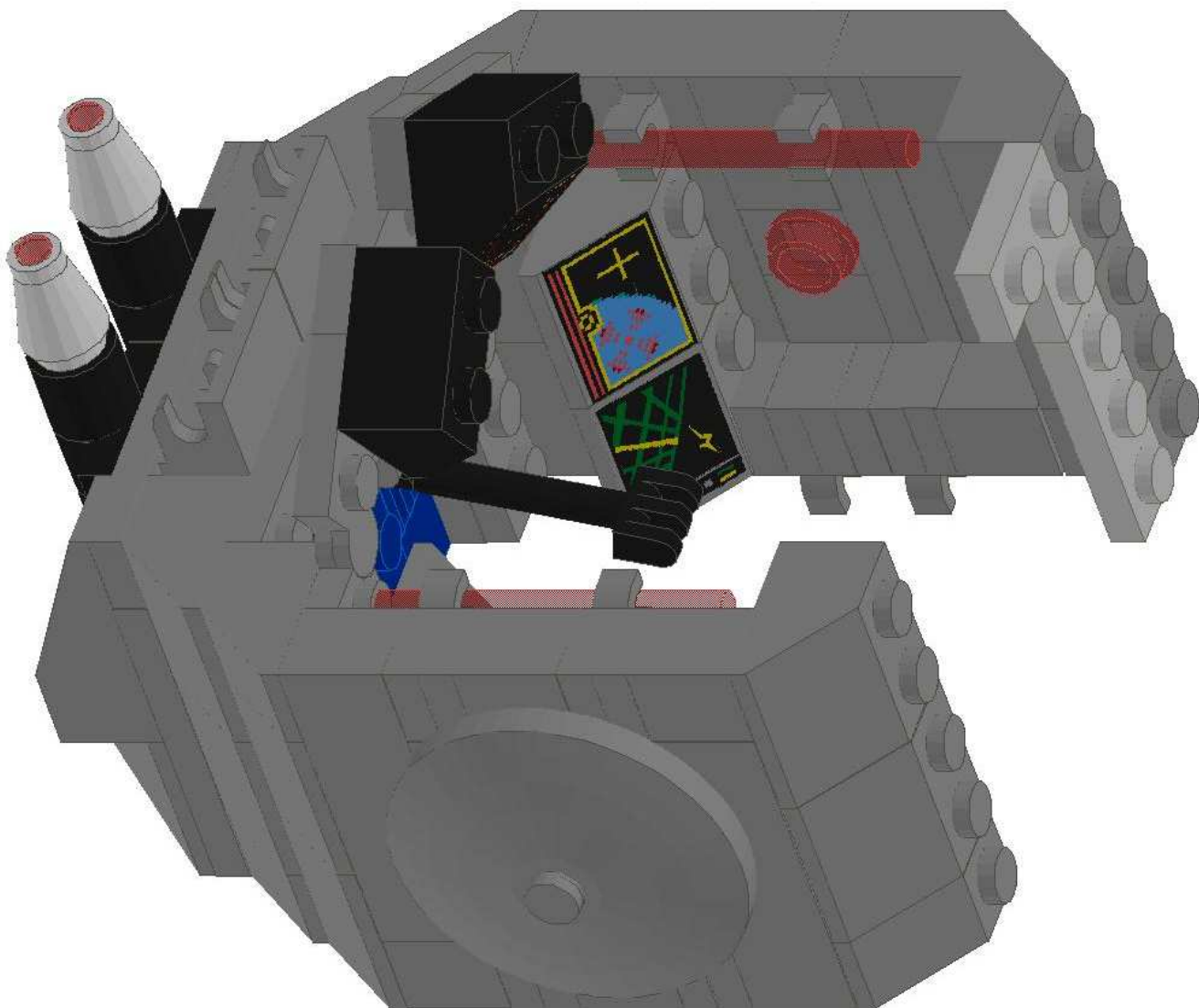

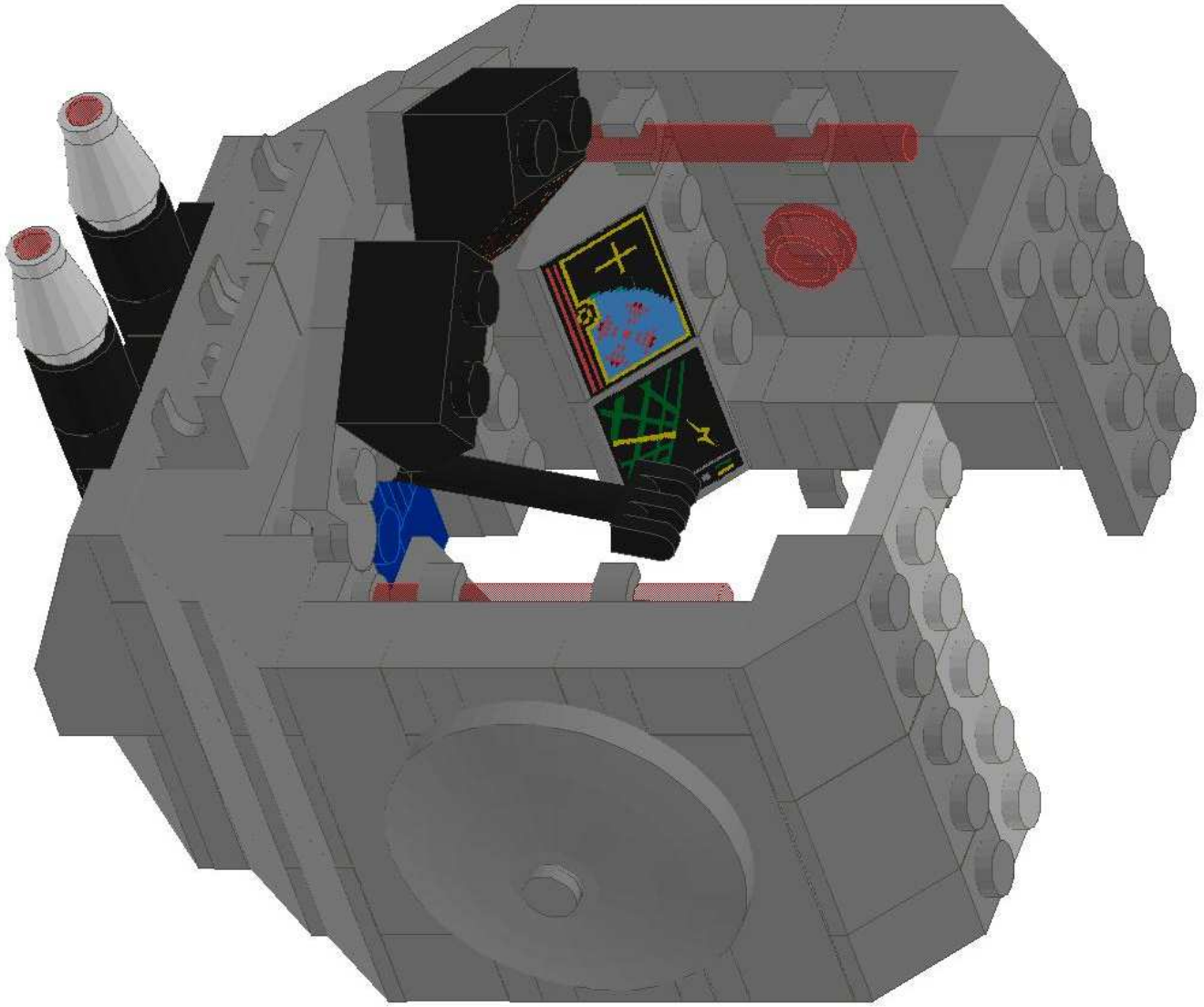

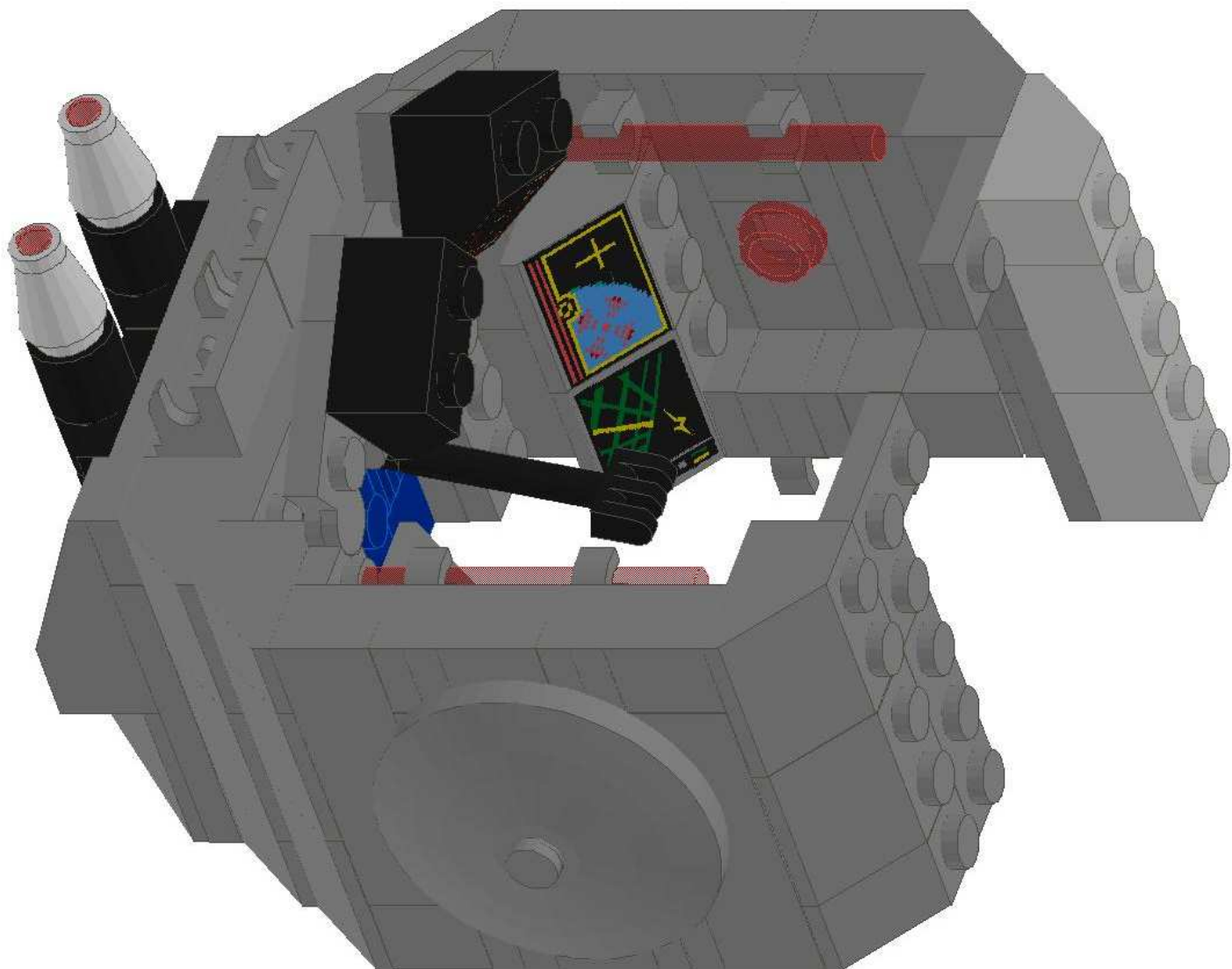

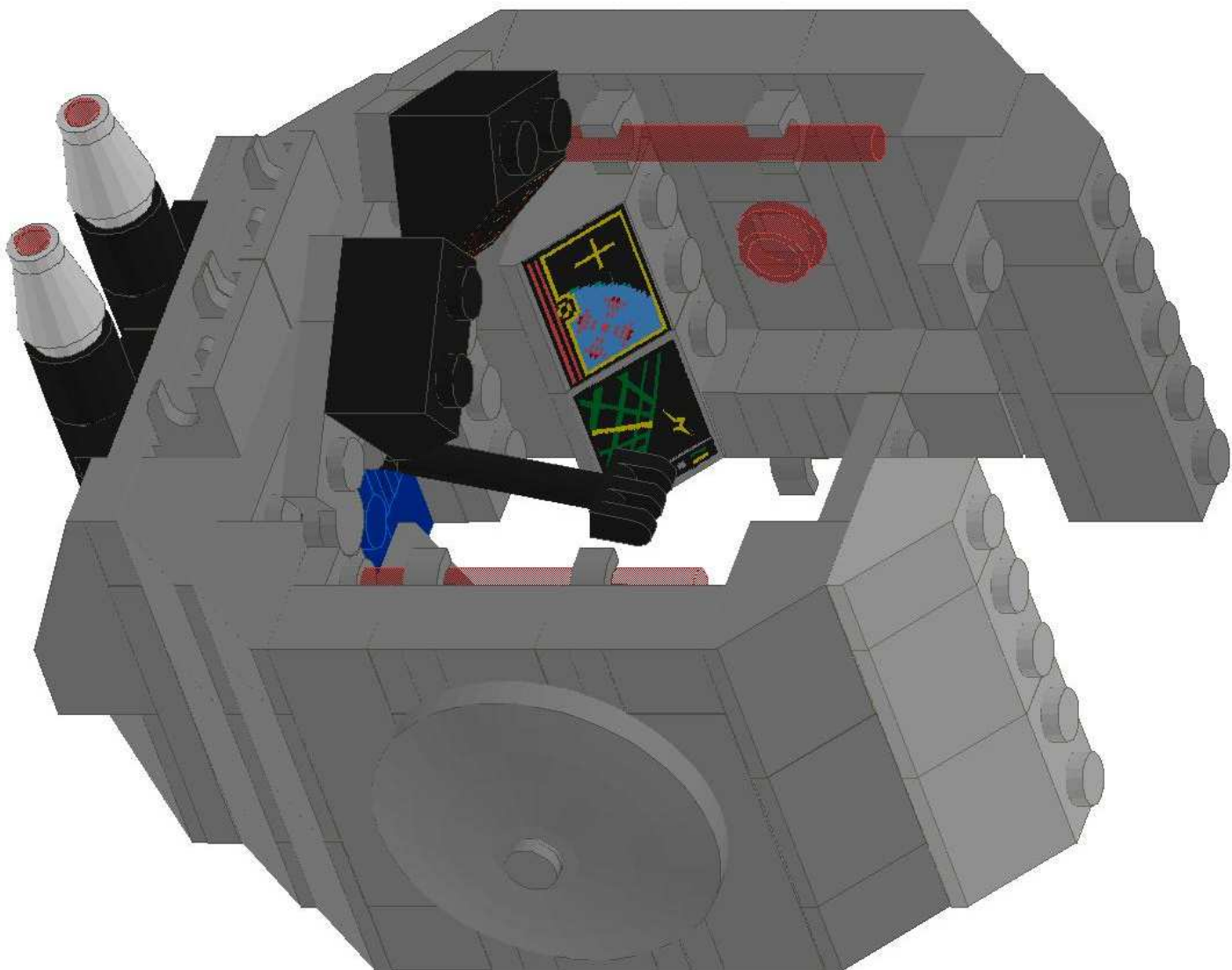

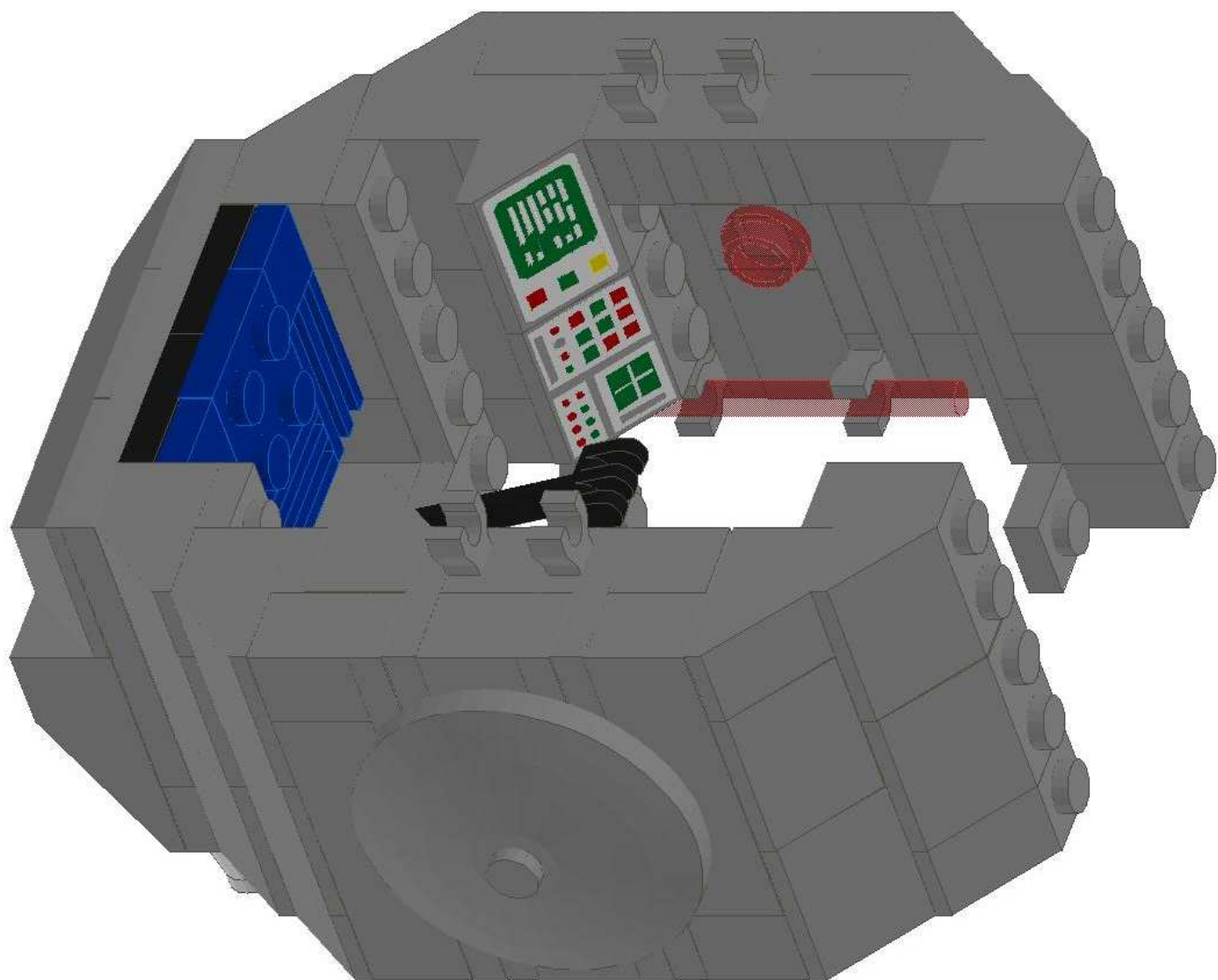

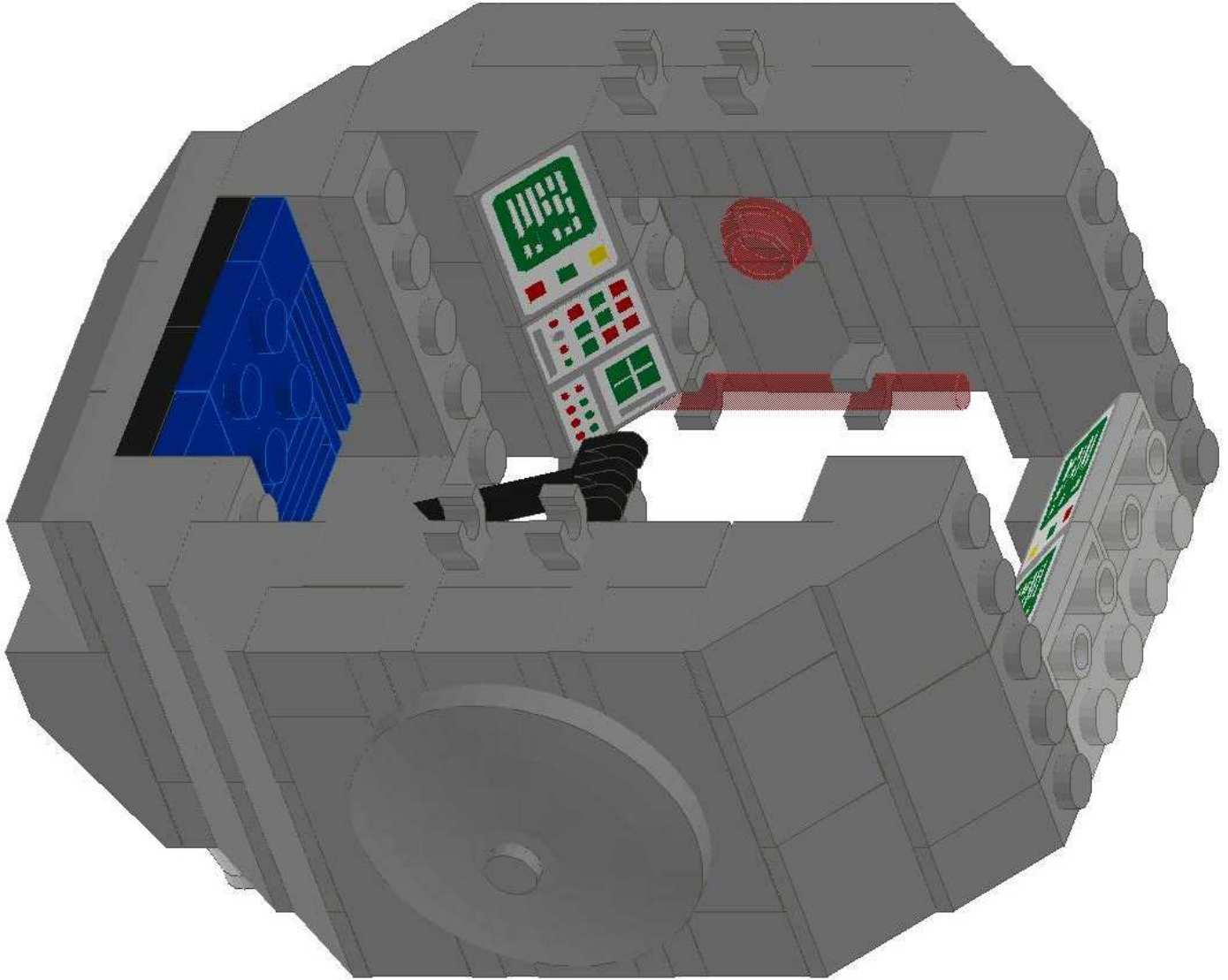

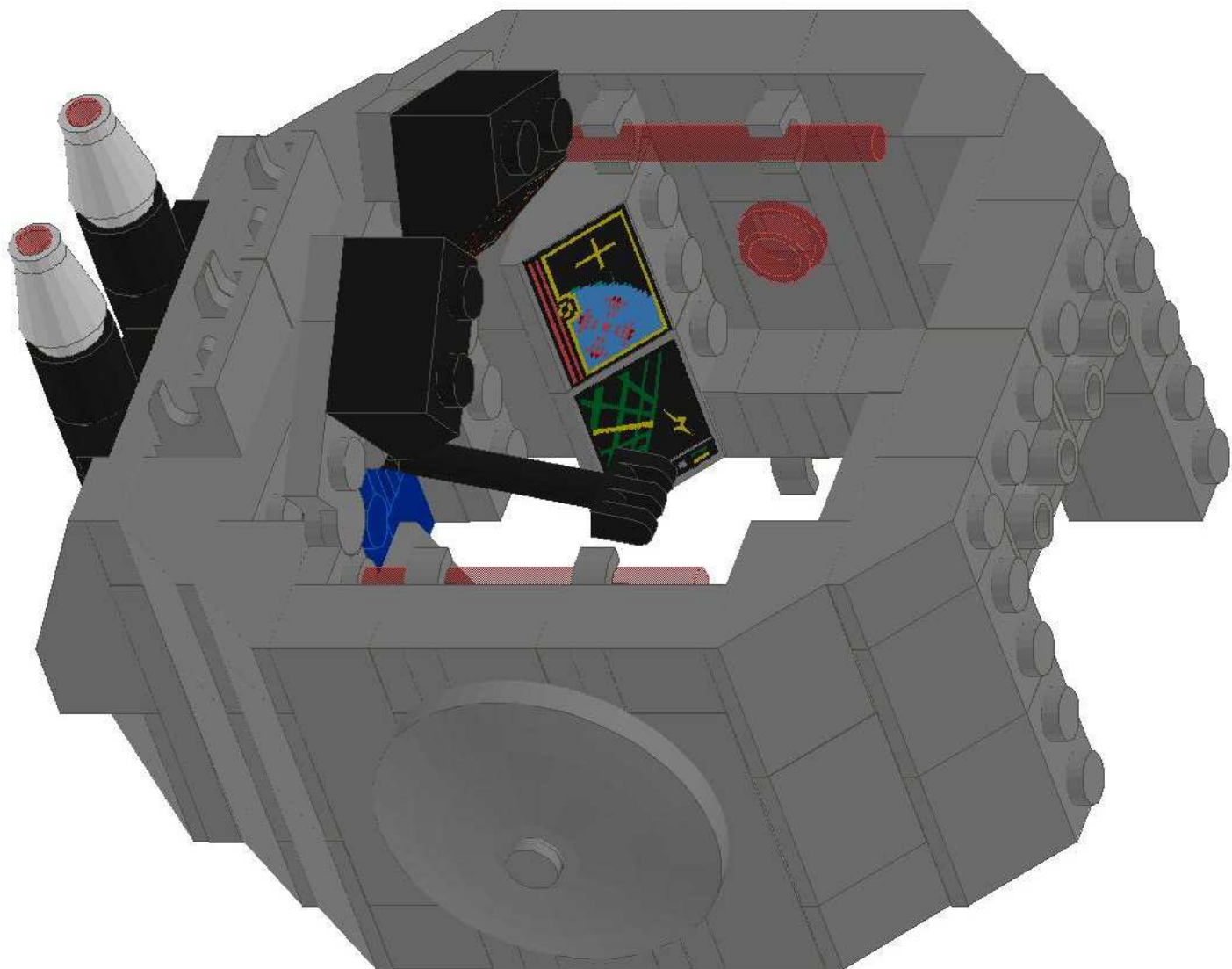

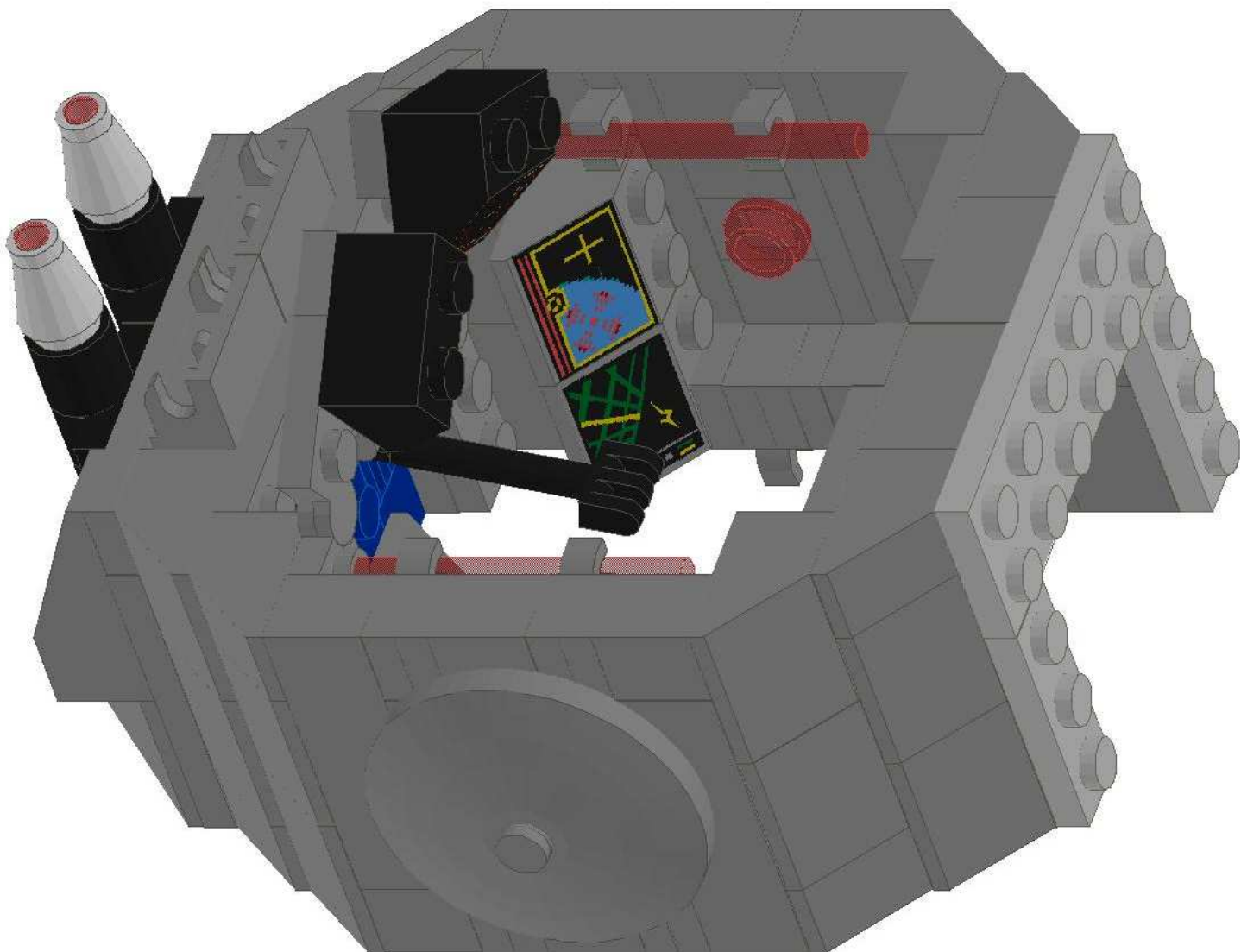

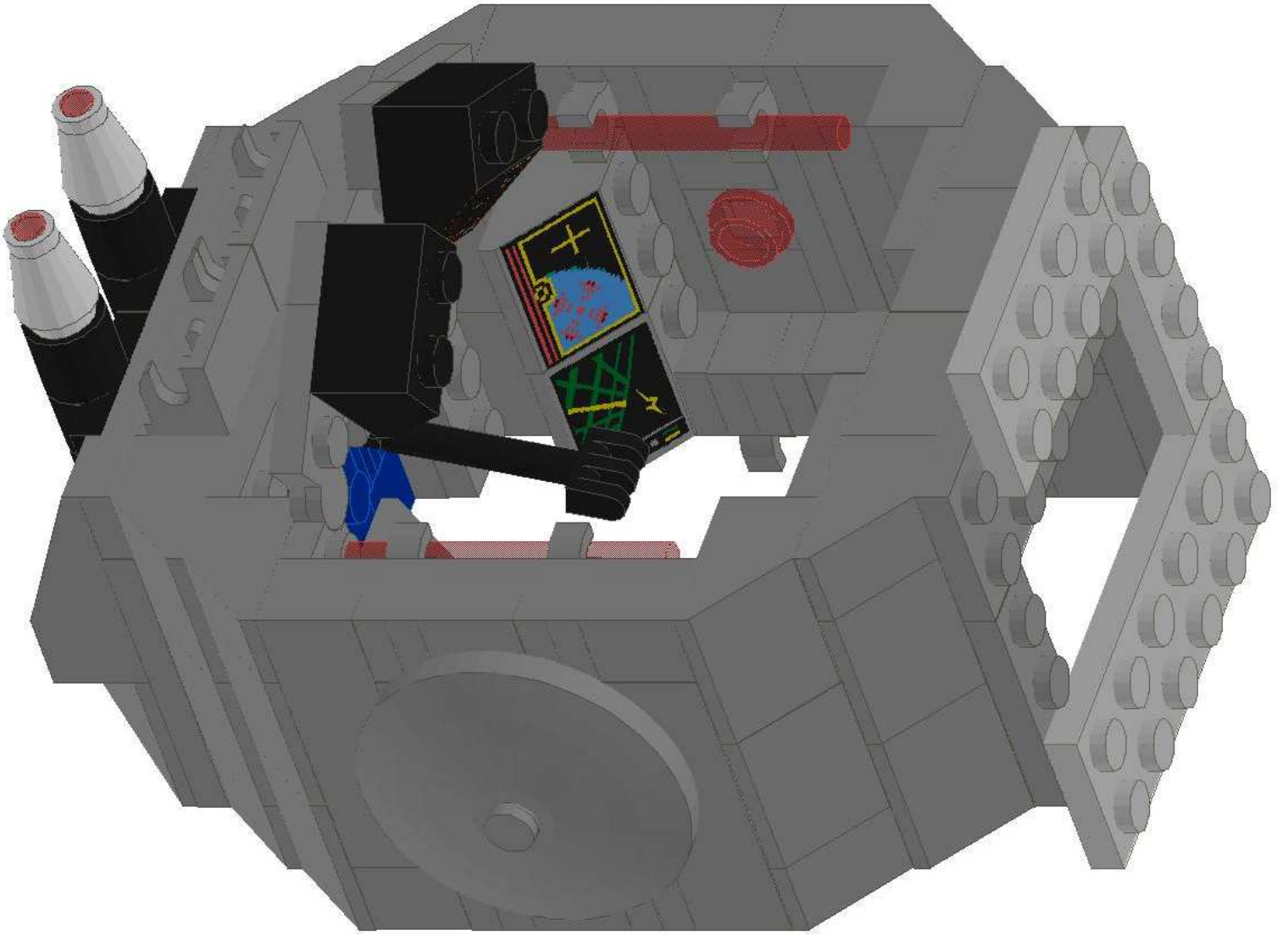

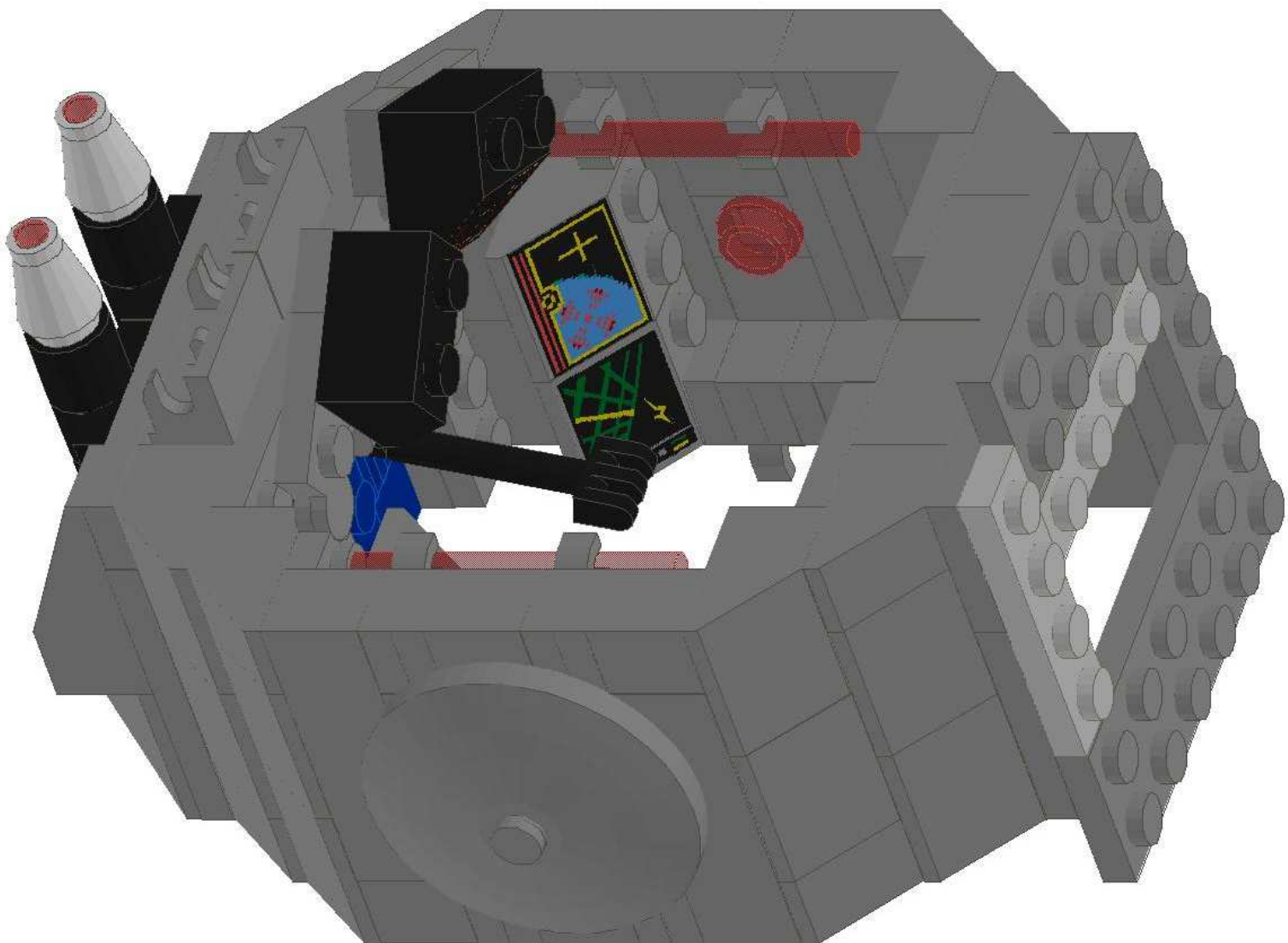

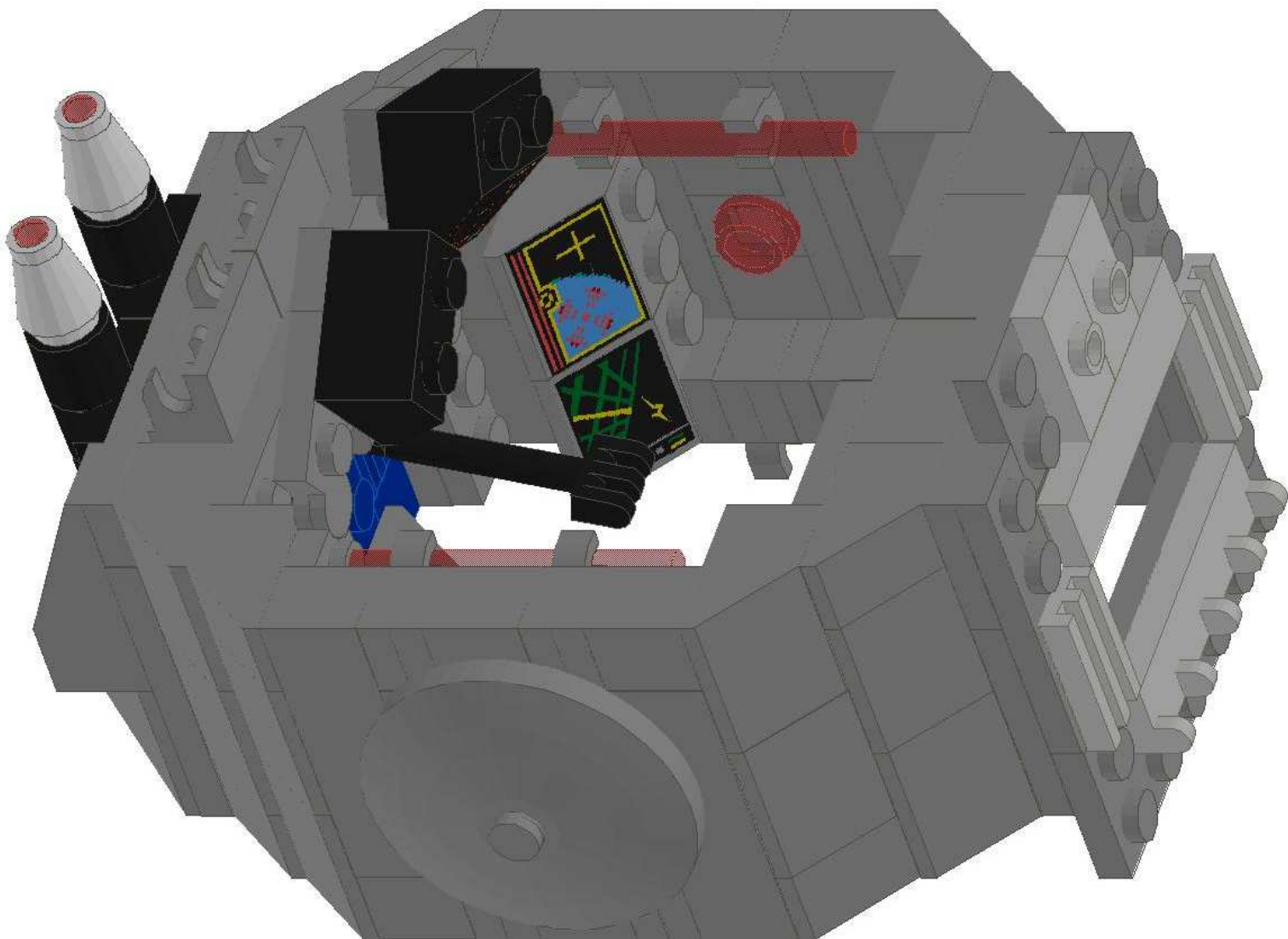

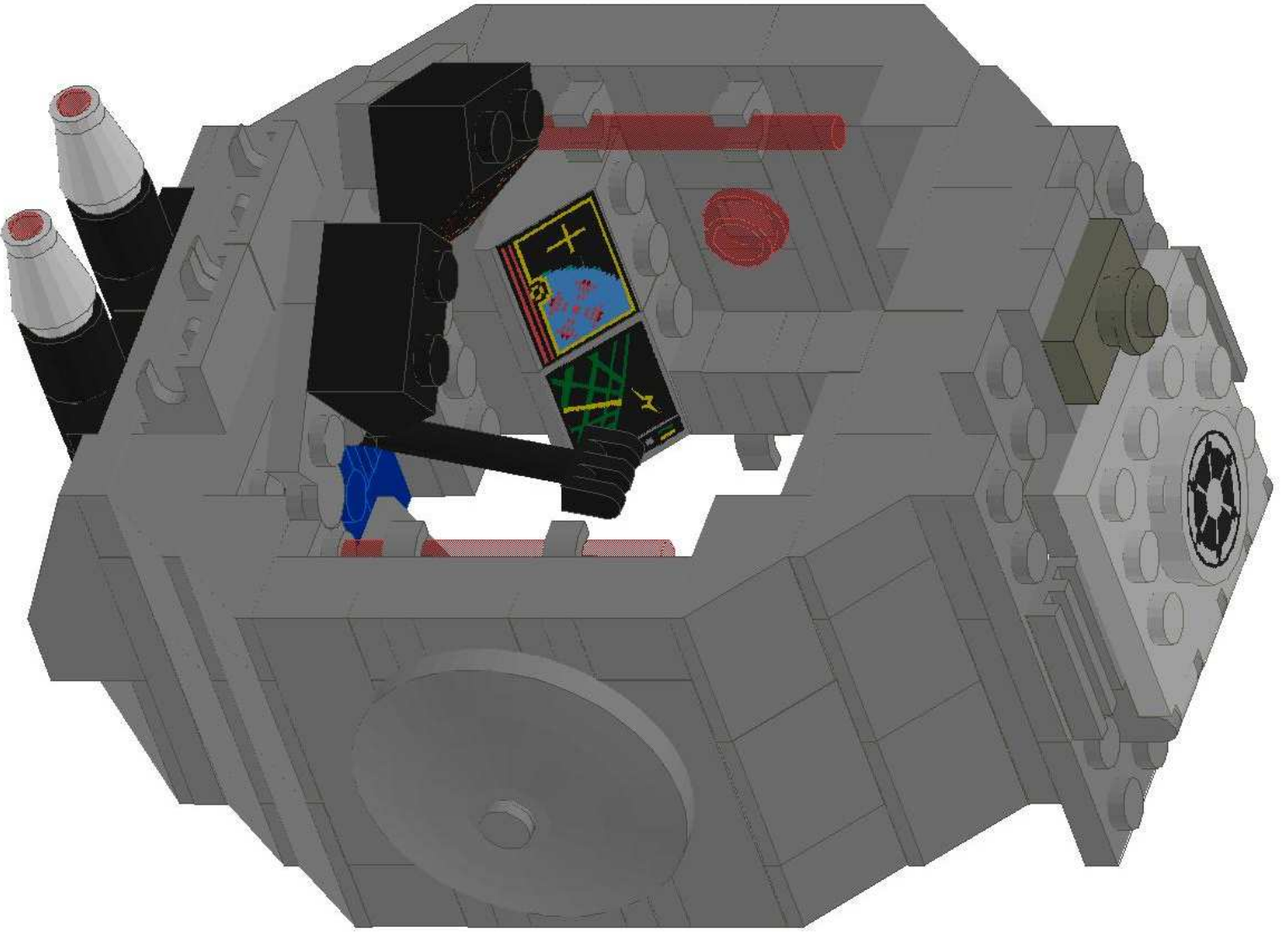

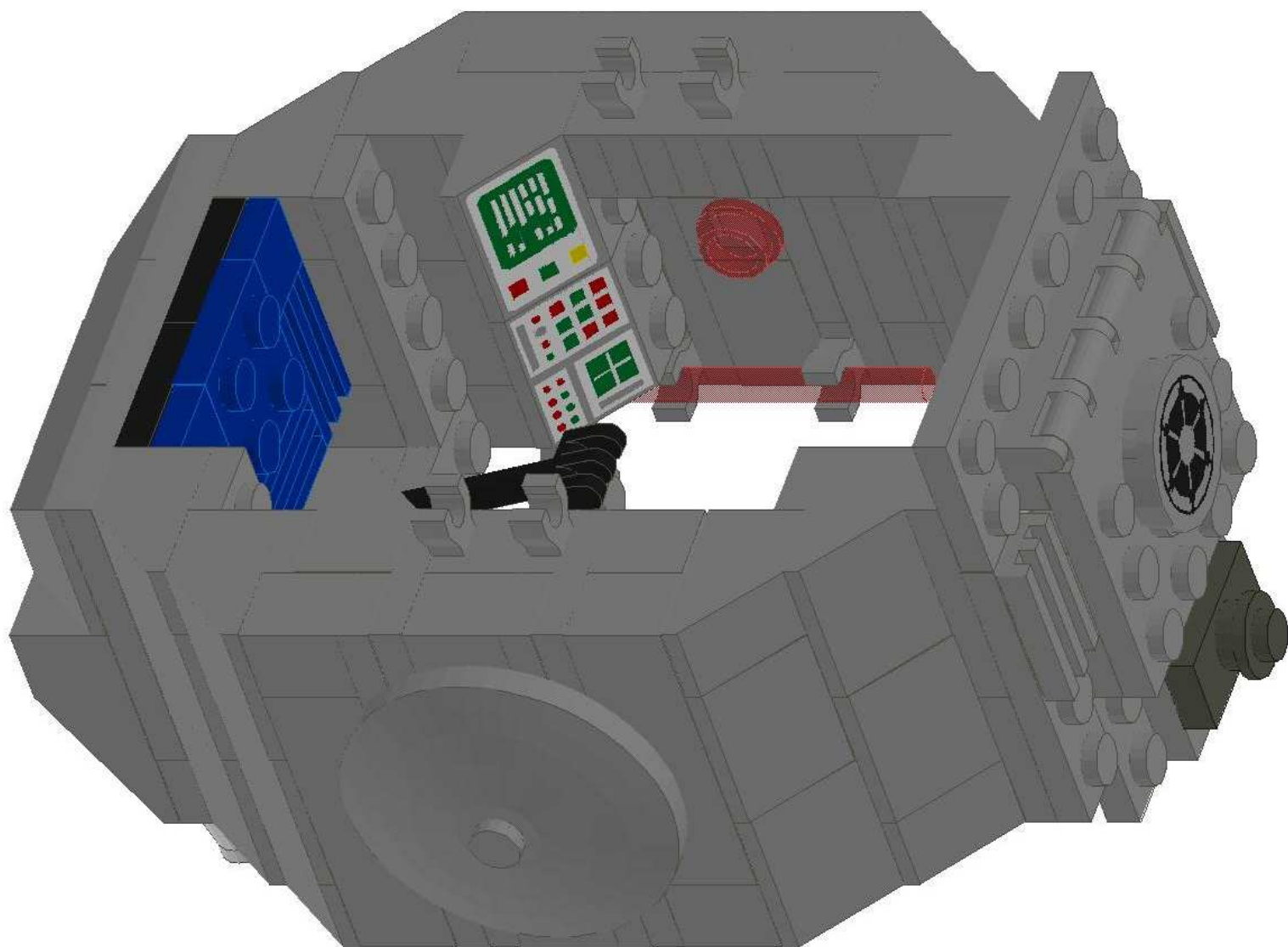

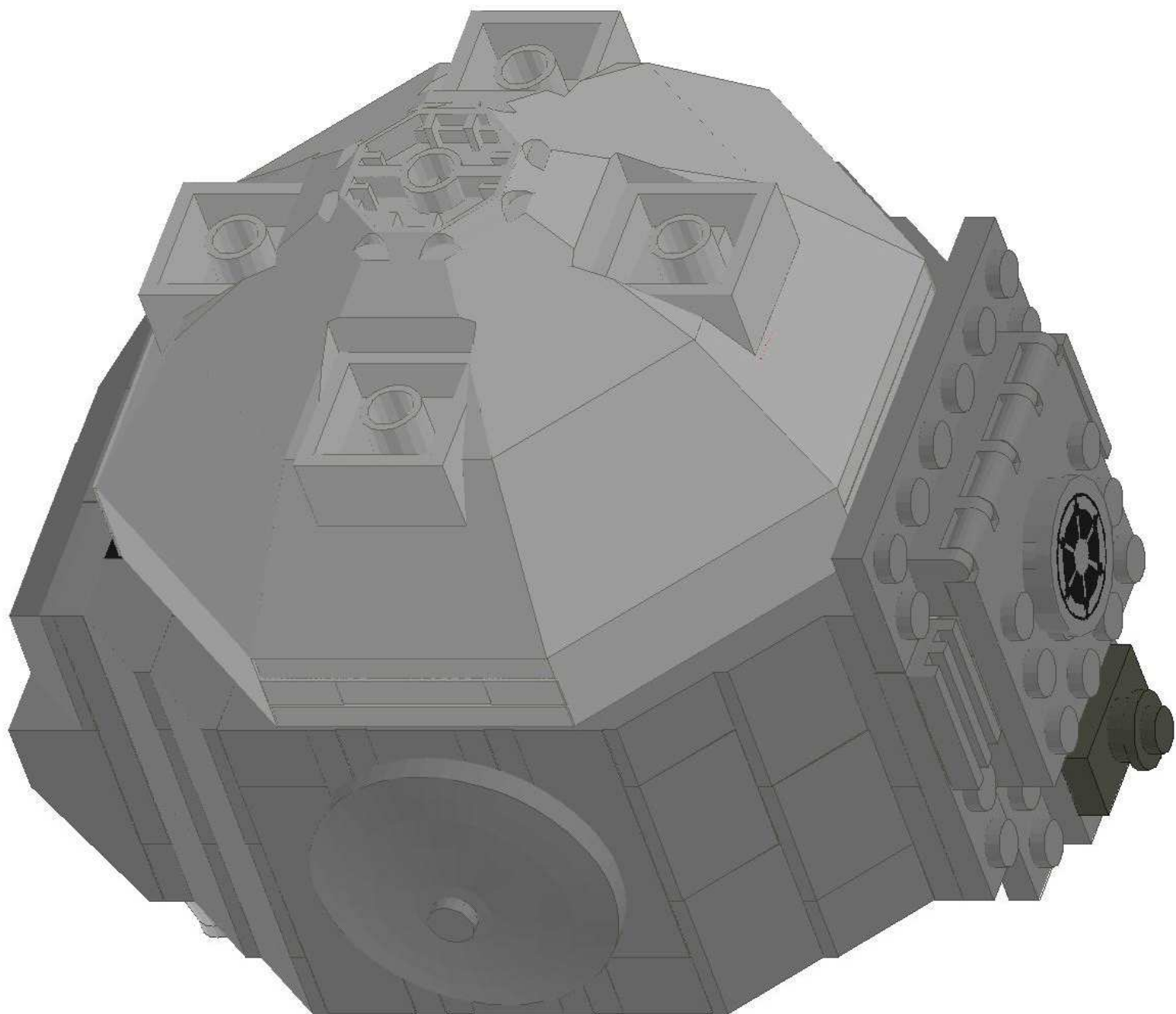



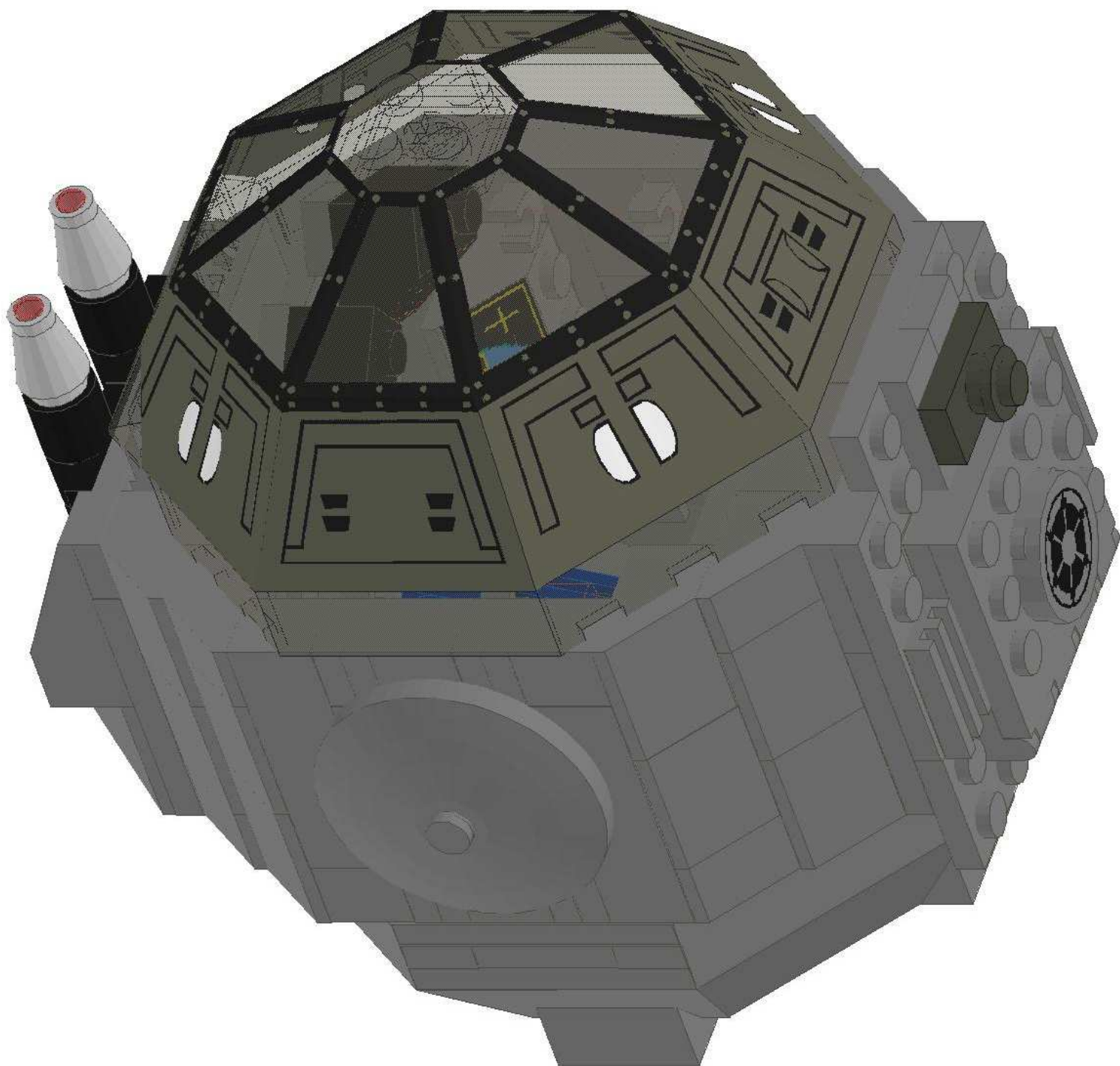



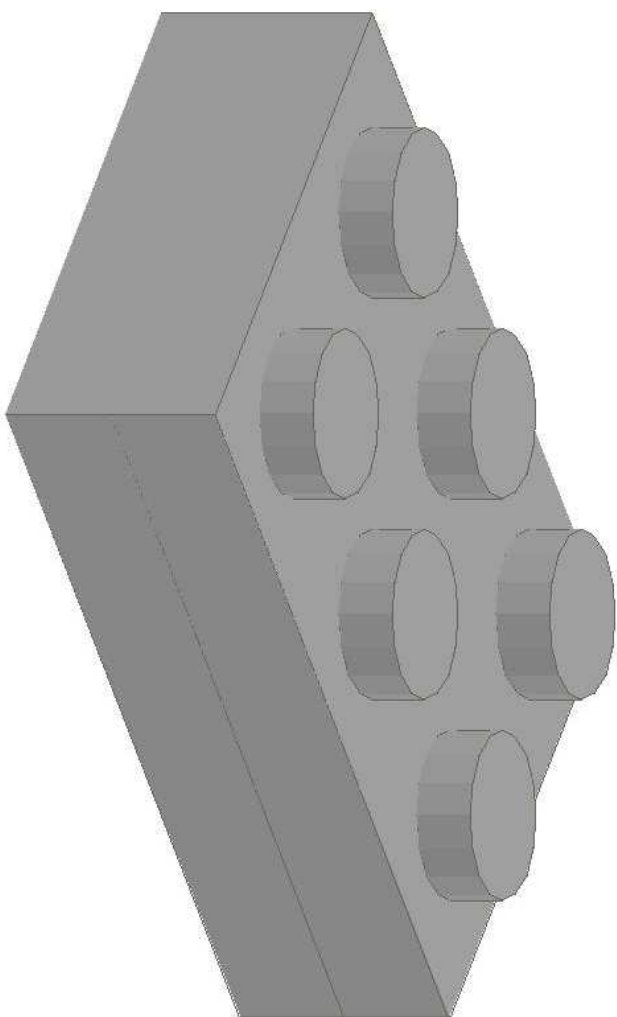

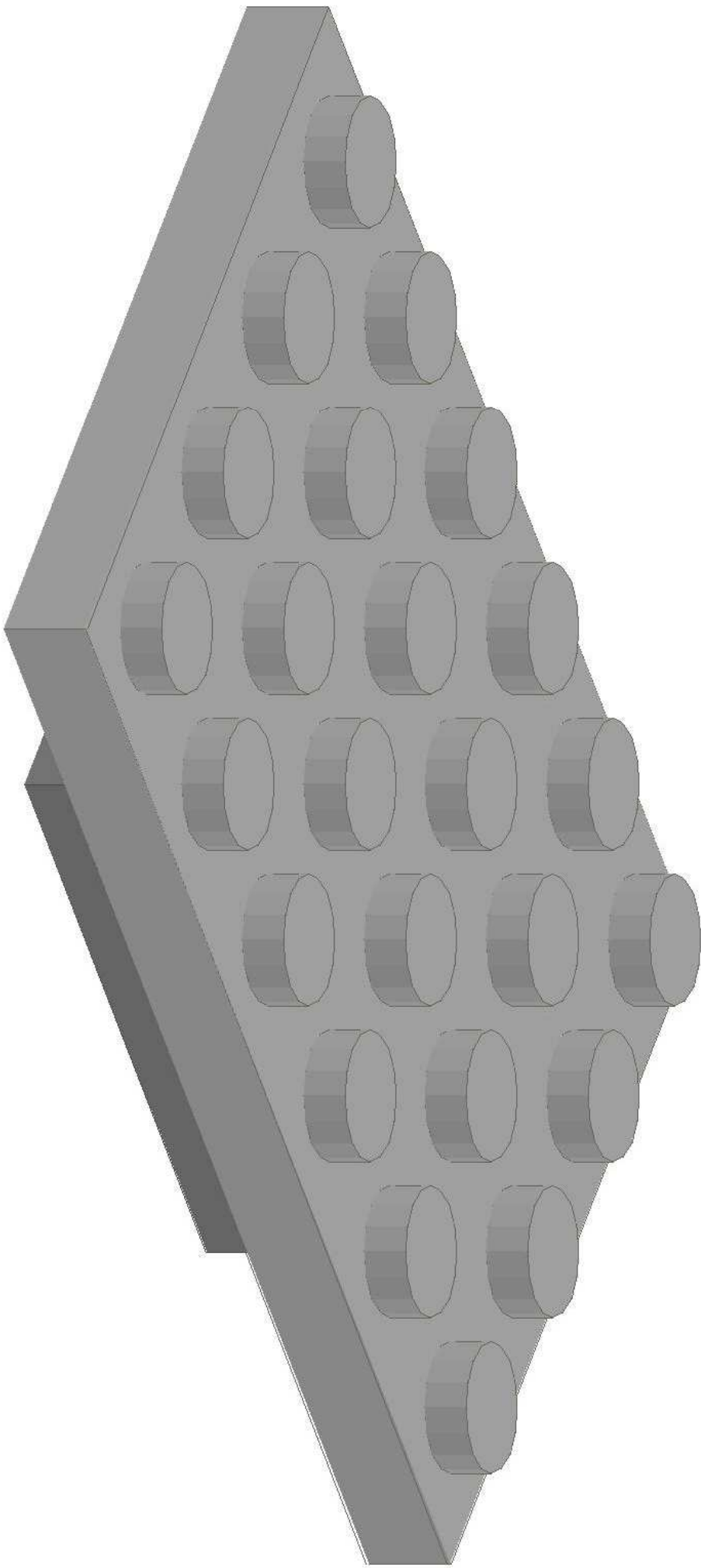

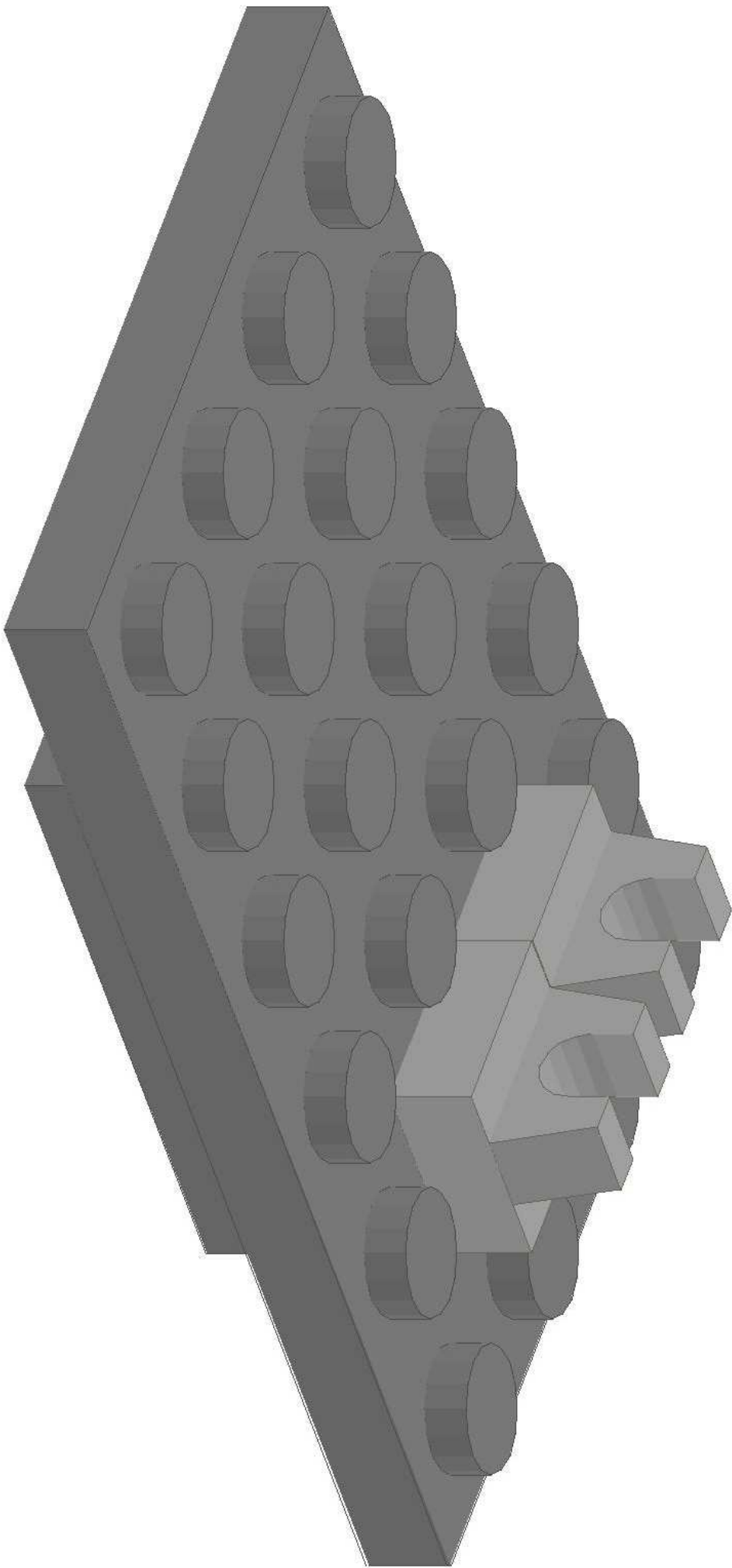

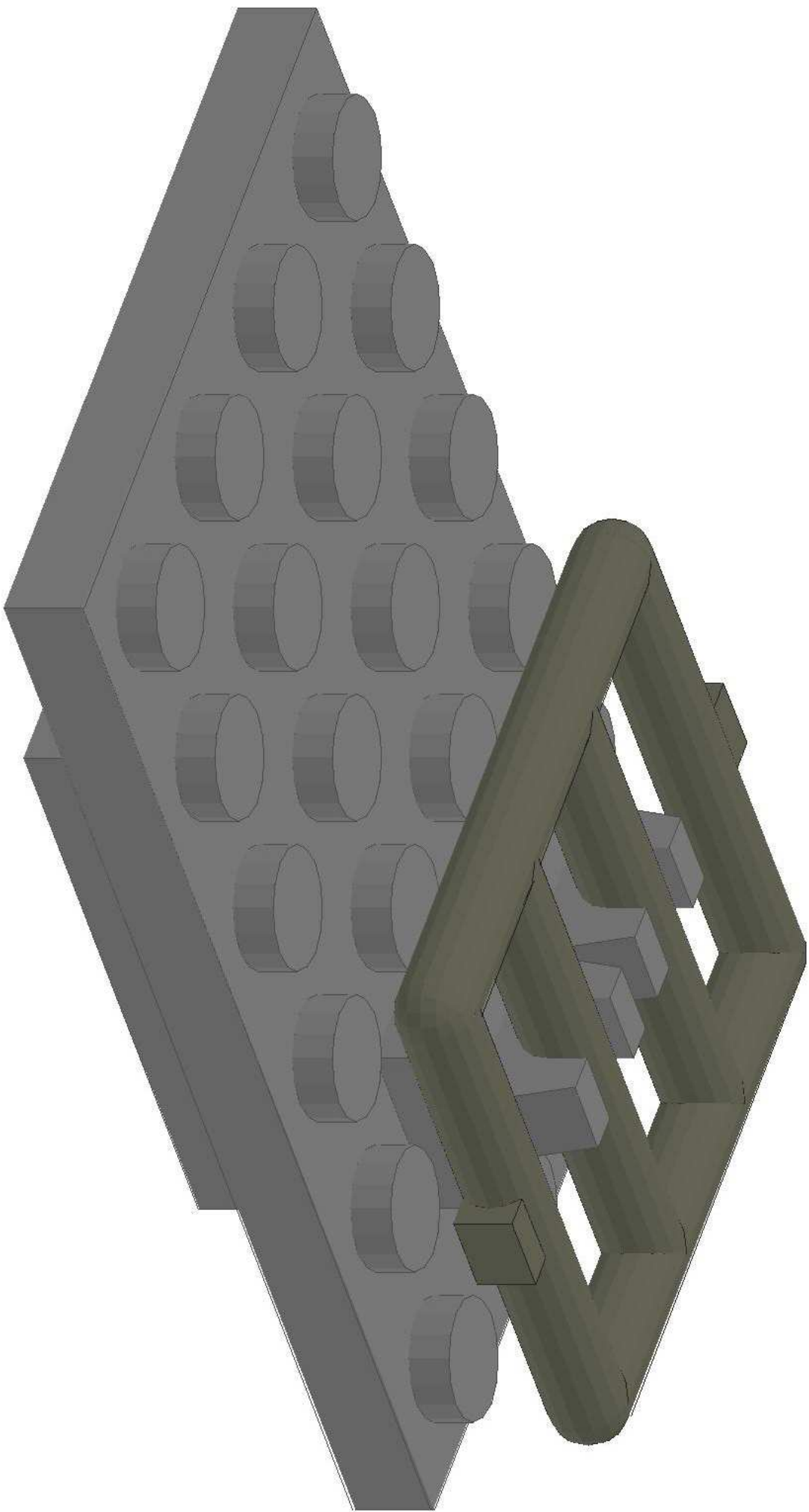

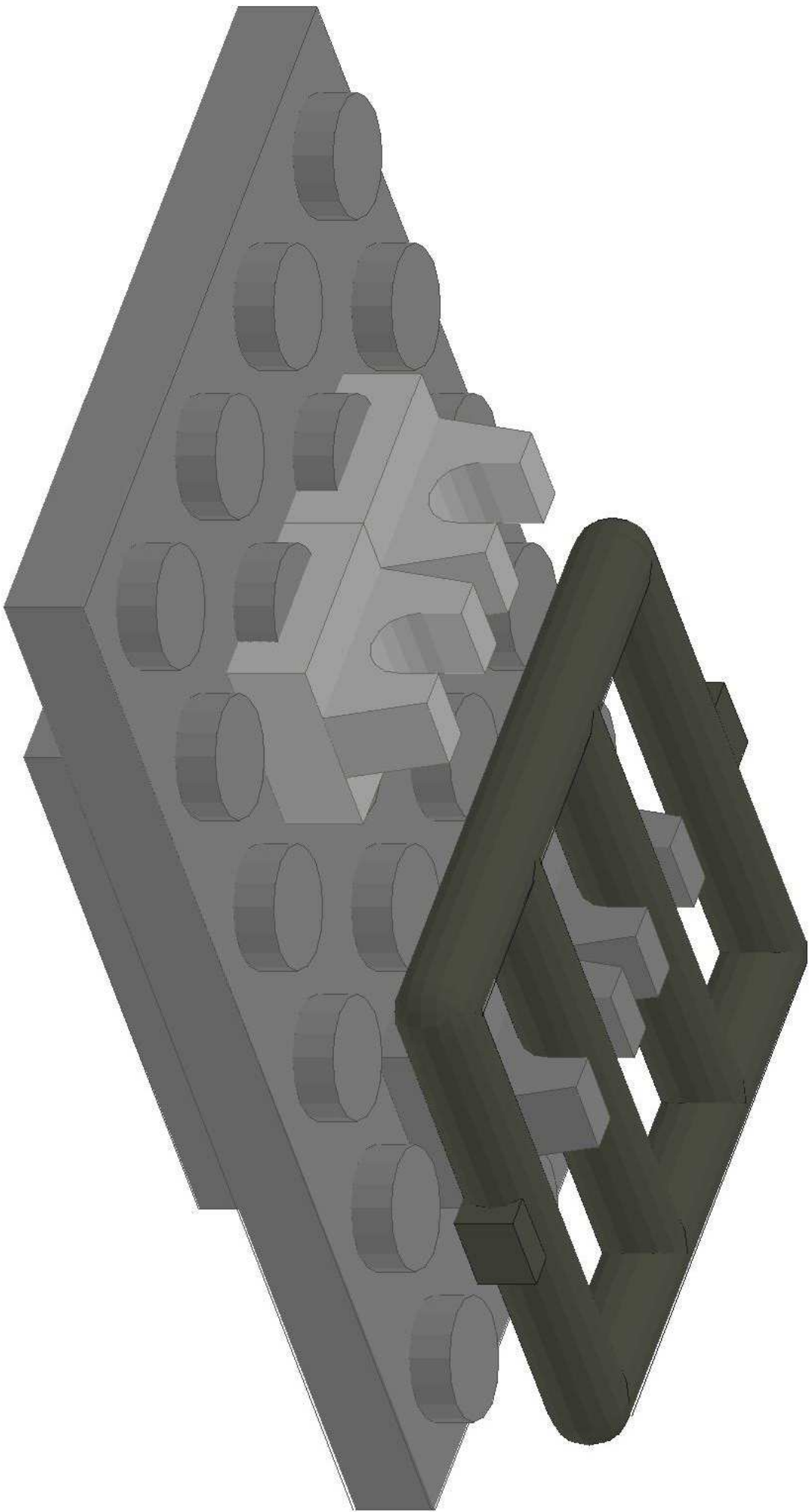

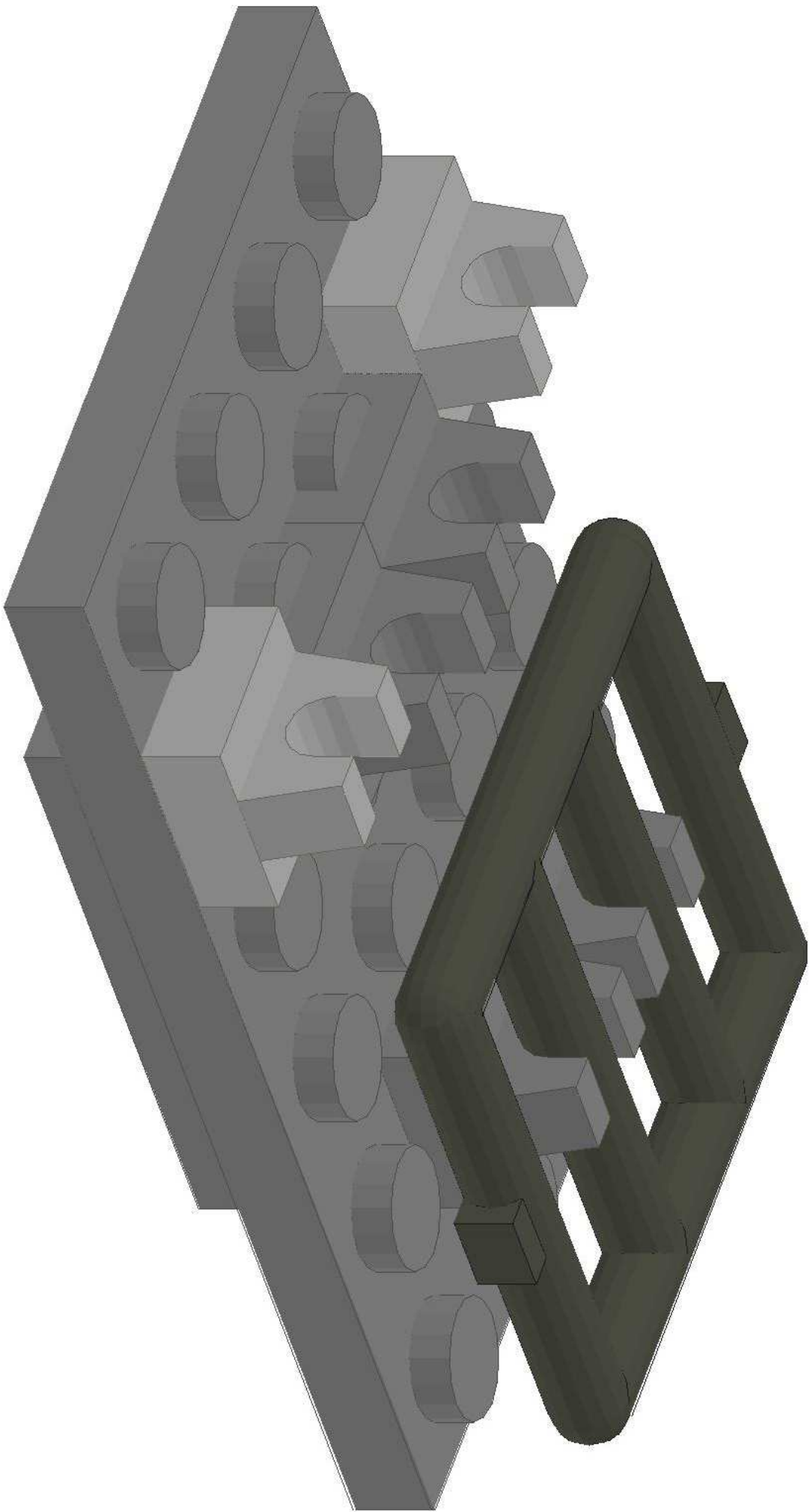

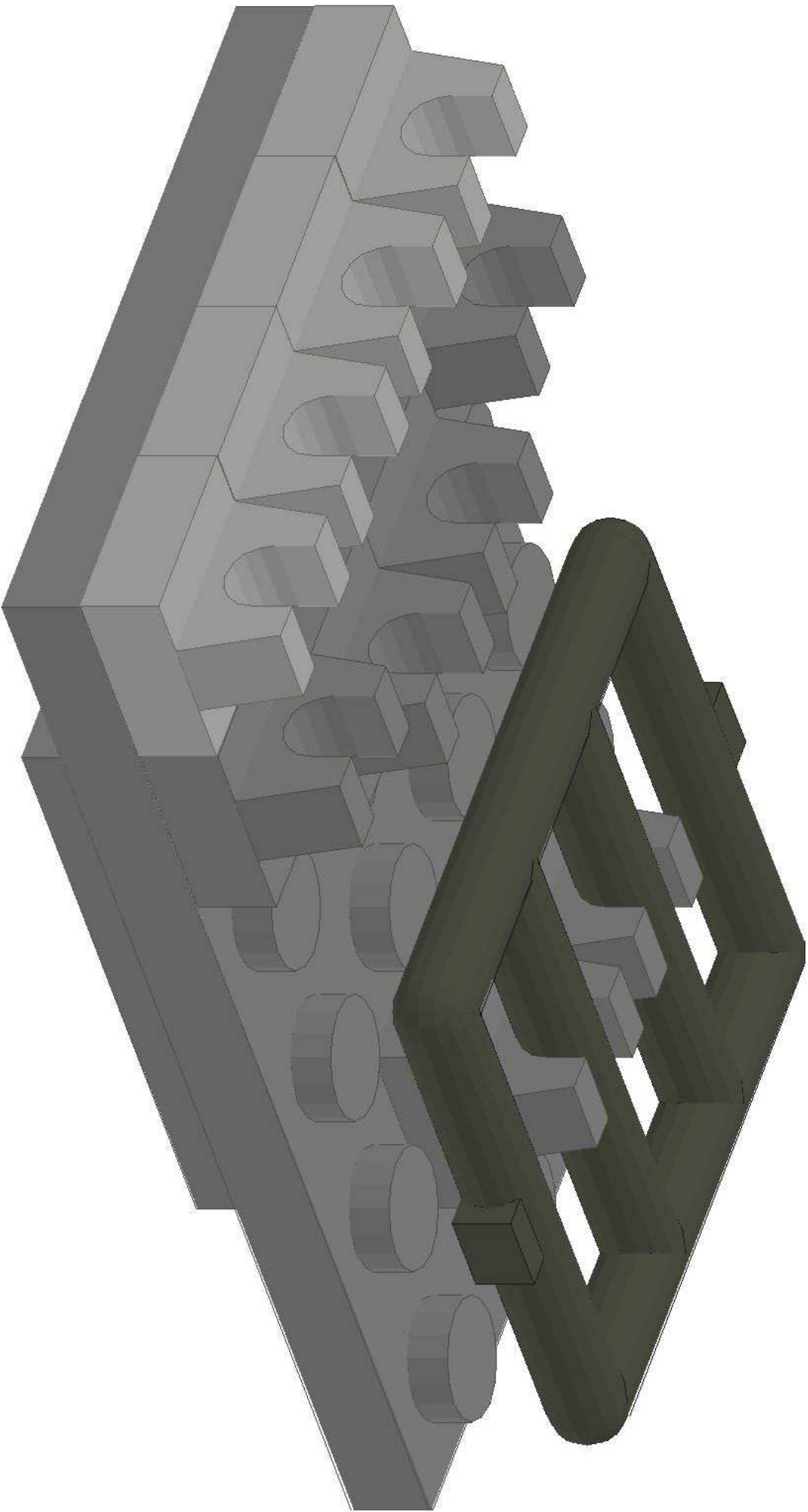

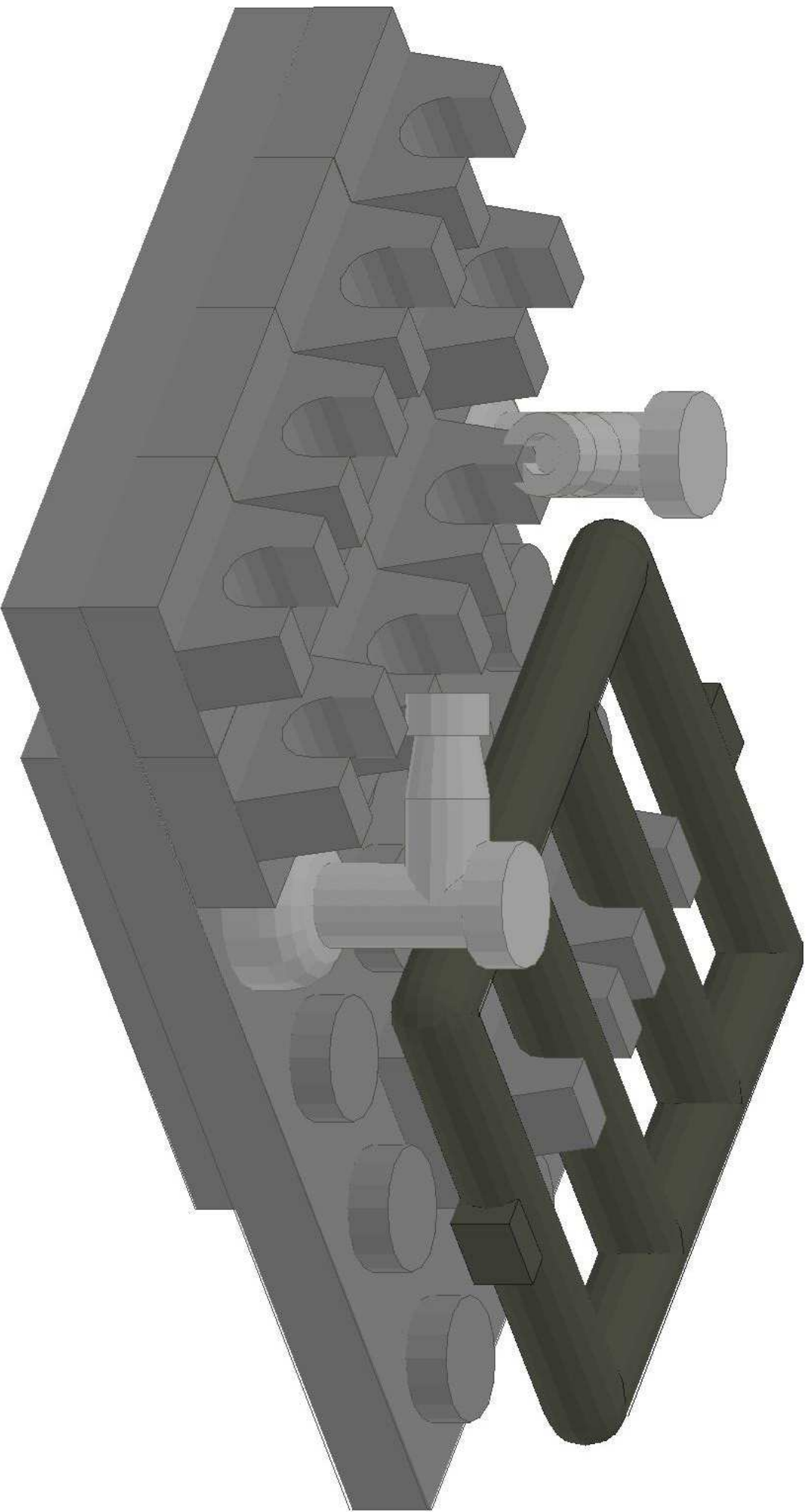

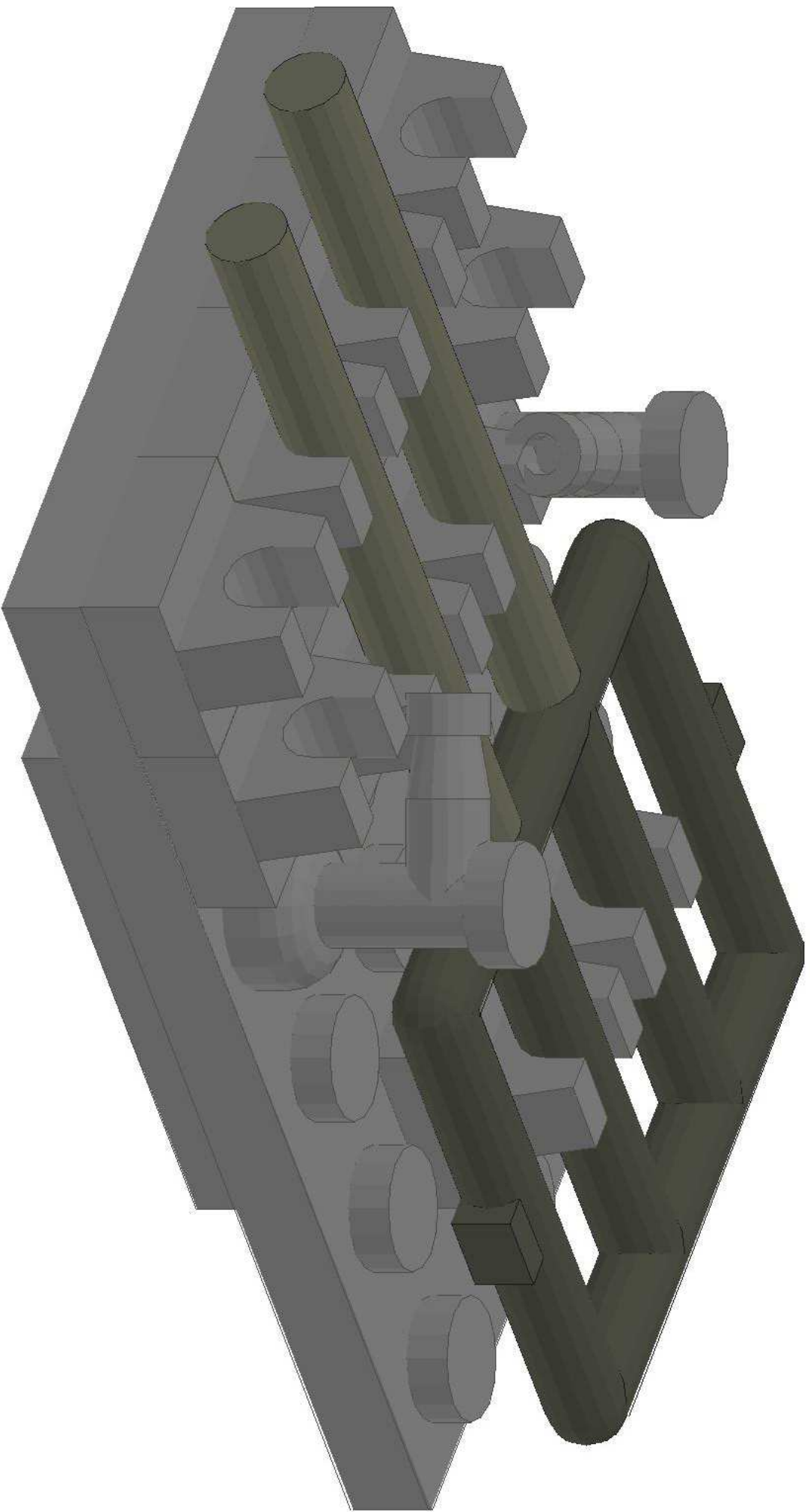

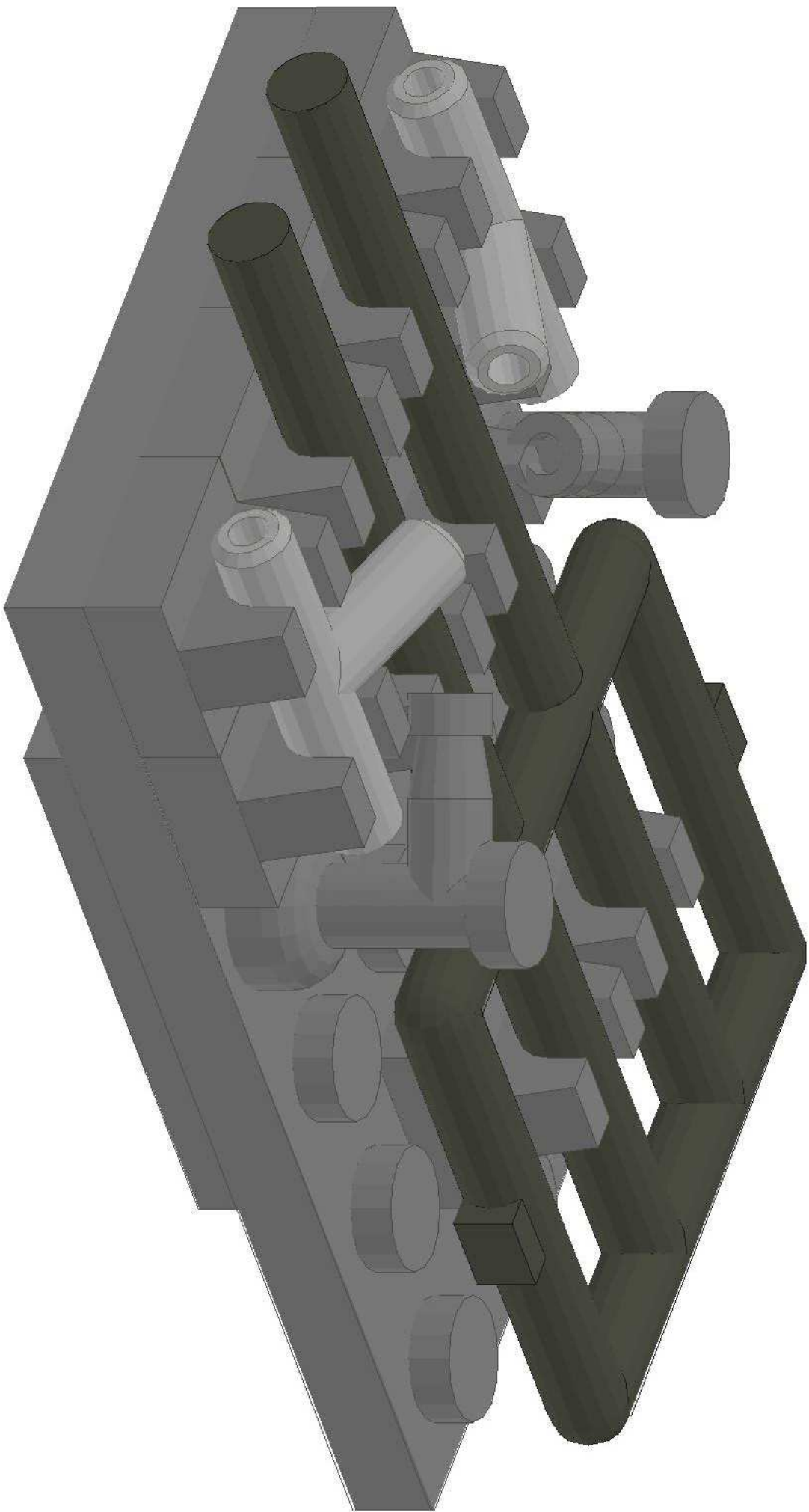

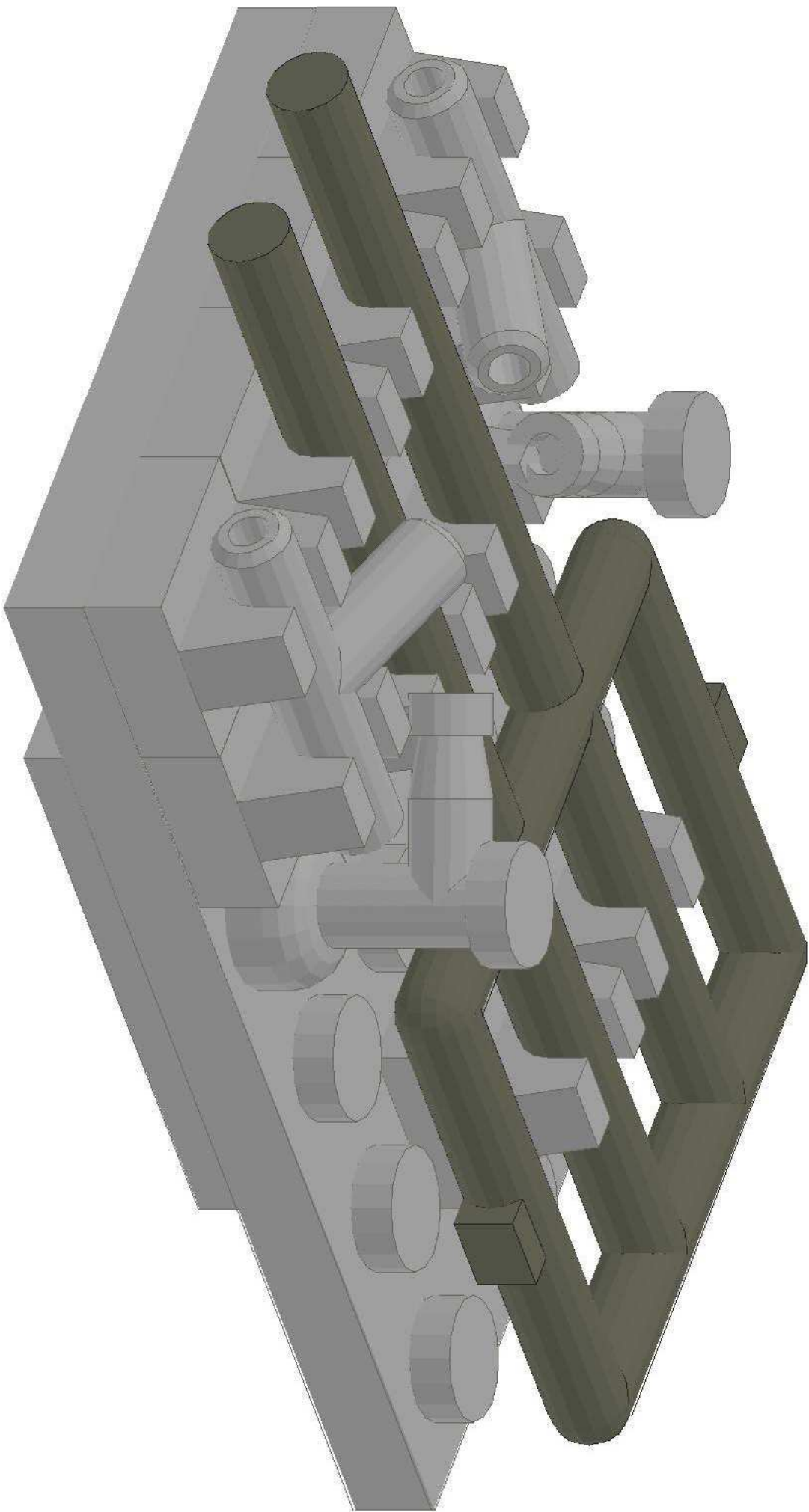

x3

